

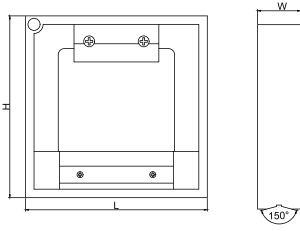

711 SERİSİ KARE SU TERAZİSİ



- ◆ İşlenmiş yüzeyleri yatay hassas ayarlama
- ◆ Hassasiyet: 0.02mm/m her çizgi
- ◆ İki V yatağı ve iki düz referans yüzeyi

Kod	Boy(LxHxW)	Fiyat
711-006-02	150x150x35mm	225 \$
711-008-02	200x200x42mm	307 \$
711-012-02	300x300x42mm	385 \$

713 SERİSİ DÜZ SU TERAZİSİ

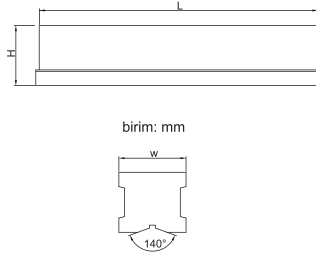

- ◆ İşlenmiş yüzeyleri yatay hassas ayarlama
- ◆ Hassasiyet: 0.02mm/m her çizgi
- ◆ V yatağı : 140°

Kod	Boy(L)	H	W	Fiyat
713-006-02	150mm	40	45	222 \$
713-008-02	200mm	42	47	247 \$
713-012-02	300mm	45	50	297 \$

722 SERİSİ DİJİTAL SU TERAZİSİ

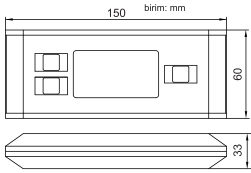

- ◆ Su terazisi veya açı ölçer olarak kullanım
- ◆ Çözünürlük: 0.05°
- ◆ Hassasiyet: $\pm 0.1^\circ$ (yatay ve dikey), $\pm 0.2^\circ$ (diğer yönlerde)
- ◆ Manyetik taban, kanallı
- ◆ Alüminyum çerçeve hassaslık ve düşük ağırlık sağlar
- ◆ Mutlak yatay referans her zaman içerisinde kayıtlı

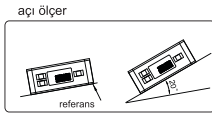
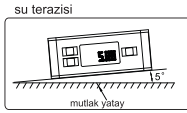

Kod	Aralık	Boy(LxWx H)	Fiyat
722-360-01	0 - 360° (90°x4)	150x60x33mm	147 \$

721 SERİSİ DİJİTAL SU TERAZİSİ

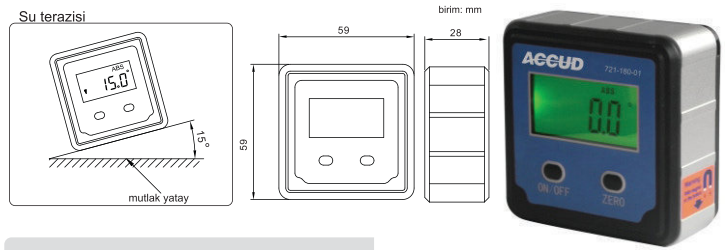

- ◆ Su terazisi veya açı ölçer olarak kullanım
- ◆ Mutlak referans içerisinde her zaman kayıtlı
- ◆ Butonlar: on/off, zero, hold
- ◆ Manyetik taban
- ◆ 4 yönde kullanım
- ◆ Otomatik kapanma

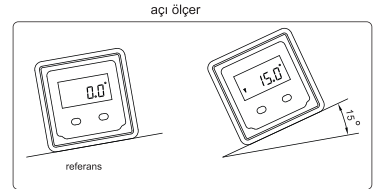

Kod	Aralık	Çözünürlük	Fiyat
721-180-01	0 - 360°(90°x4)	0.1°	80 \$

726 SERİSİ DİJİTAL AÇI ÖLÇER

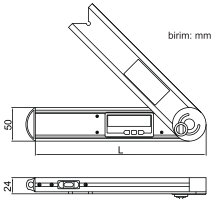

- ◆ Butonlar: ON/OFF, HOLD, ZERO, ABS
- ◆ Ölçüm aralığı ayarı: 0°~225°, -225°~0°, -45°~180°, -180°~45°
- ◆ Mekanik su terazisi ile
- ◆ Otomatik kapanma

Kod	Aralık	Çözünürlük	Hassasiyet	Boy (L)	Fiyat
726-360-01	0 - 360°	0.05°	$\pm 0.15^\circ$	250mm	125 \$

725 SERİSİ DİJİTAL SU TERAZİSİ

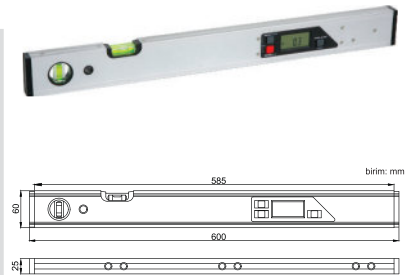

- ◆ Su terazisi veya açı ölçer
- ◆ Hassasiyet : $\pm 0.1^\circ$ (yatay ve dikey), $\pm 0.2^\circ$ (diğer yönler)
- ◆ Butonlar: on/off, ABS, hold, alarm unit, backlight
- ◆ Yatay ve dikey terazi
- ◆ Mutlak yatay referans her zaman kayıtlı
- ◆ Manyetik taban
- ◆ Ölçüm yönünü otomatik ayarlama

Kod	Aralık	Çözünürlük	Fiyat
725-360-01	0 - 360° (4x90°)	0.1°	182 \$

811 SERİSİ AÇI ÖLÇER

811-180-01

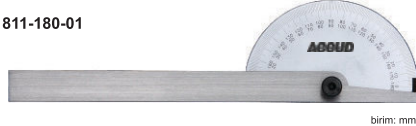

birim: mm



811-180-02

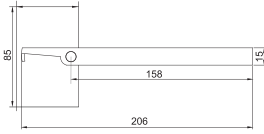

- ♦ Okuma: 1°
- ♦ Paslanmaz çelik
- ♦ Krom kaplama cetvel
- ♦ Kilitleme vidası

Kod	Ölçü	Aralık	Hassasiyet	Fiyat
811-180-01	85x150mm	0 - 180°	±0.3°	22 \$
811-180-02	85x158mm	0 - 180°	±0.3°	27 \$

812 SERİSİ AÇI ÖLÇER

812-003-01



birim: mm

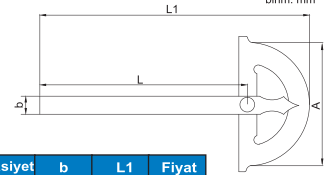

- ♦ Okuma: 1°
- ♦ Krom kaplama cetvel
- ♦ Kilitleme vidası

Kıd	Ölçü(AxL)	Aralık	Hassasiyet	b	L1	Fiyat
812-003-01	80x120mm	0 - 180°	±0.3°	11	165	36 \$
812-005-01	120x150mm	0 - 180°	±0.3°	14	220	40 \$
812-006-01	150x200mm	0 - 180°	±0.3°	16	285	49 \$
812-008-01	200x300mm	0 - 180°	±0.3°	20	413	66 \$
812-012-01	300x500mm	0 - 180°	±0.3°	30	675	98 \$

813 SERİSİ AÇI ÖLÇER

813-006-01



- ♦ Okuma: 1°
- ♦ Paslanmaz çelik
- ♦ Krom kaplama cetvel
- ♦ Hareketli bıçak

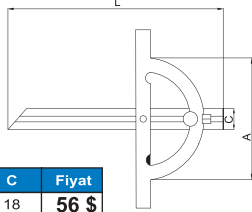

Kod	Ölçü (AxL)	Aralık	Hassasiyet	C	Fiyat
813-006-01	100x150mm	10 - 170°	±0.3°	18	56 \$
813-012-01	150x300mm	10 - 170°	±0.3°	18	67 \$
813-016-01	200x400mm	10 - 170°	±0.3°	20	83 \$
813-020-01	250x500mm	10 - 170°	±0.3°	20	134 \$
813-024-01	300x600mm	10 - 170°	±0.3°	20	165 \$

814 SERİSİ AÇI ÖLÇER

birim: mm

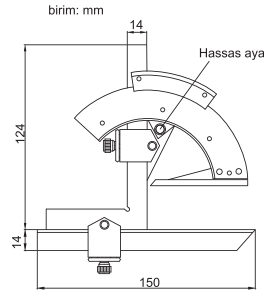

Hassas ayar

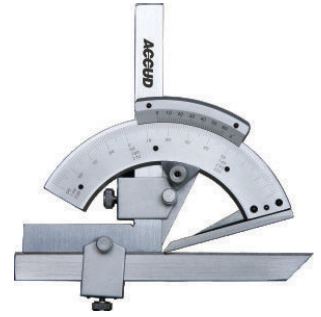

- ♦ Okuma: 2'
- ♦ Paslanmaz çelik
- ♦ Krom kaplama cetvel

Kod	Aralık	Hassasiyet	Fiyat
814-320-01	0 - 320°	±2'	175 \$

815 SERİSİ UNIVERSAL AÇI ÖLÇER

birim: mm

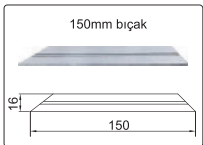

- ♦ Okuma: 5'
- ♦ Tek bıçak: 150mm
- ♦ Paslanmaz çelik
- ♦ Opsiyonel aksesuar: Mihengirler için tutucu

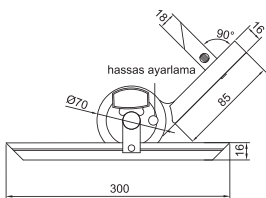

Kod	Aralık	Hassasiyet	Fiyat
815-360-01	0 - 360°	±5'	129 \$

816 SERİSİ UNIVERSAL AÇI ÖLÇER

birim: mm

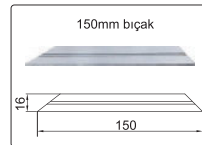

- ♦ Okuma: 5'
- ♦ Tek bıçak: 150mm
- ♦ Karbon çeliği
- ♦ Opsiyonel aksesuar: Mihengirler için tutucu

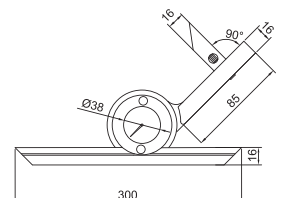

Kod	Aralık	Hassasiyet	Fiyat
816-360-01	0 - 360°	±5'	161 \$

817 SERİSİ

KOMBİNE AÇI ÖLÇER GÖNYE SETİ

- ◆ Açı ölçer:
Açı ayarlama ve açı ölçümleri için,
Ölçüm aralığı: 0-180°,
hassasiyet: ±7'
- ◆ Gönye:
90° square veya
45° gönye olarak kullanım
90° gönye hassasiyeti: ±8',
45° gönye hassasiyeti: ±10'
- ◆ Cetvel:
Ölçüm aralığı: 300mm/12"
- ◆ Merkezleyici:
Silindirik merkezlerini bulmak için,
Hassasiyet: ±0.15mm

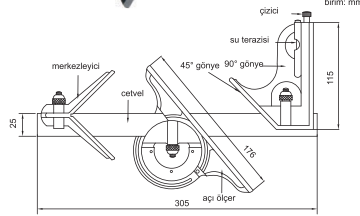
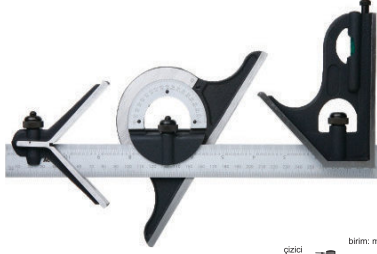

Kod	Fiyat
817-180-02	170 \$

821 SERİSİ

DİJİTAL AÇI ÖLÇER

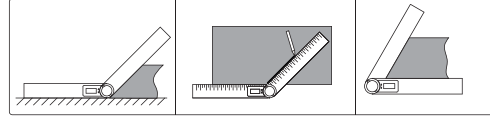

821-008-01

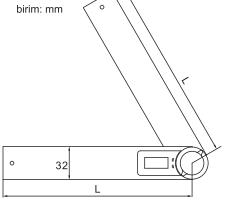

- ◆ Çözünürlük: 0.1°
- ◆ Butonlar: on/off, zero
- ◆ Kilitleme mandalı
- ◆ Cetvel okuma: 1mm and 1/32"
- ◆ Otomatik kapanma

Kod	Boy(L)	Aralık	Hassasiyet	Fiyat
821-008-01	200mm	0 - 360°	±0.3°	62 \$
821-012-01	300mm	0 - 360°	±0.3°	69 \$

822 SERİSİ

DİJİTAL AÇI ÖLÇER

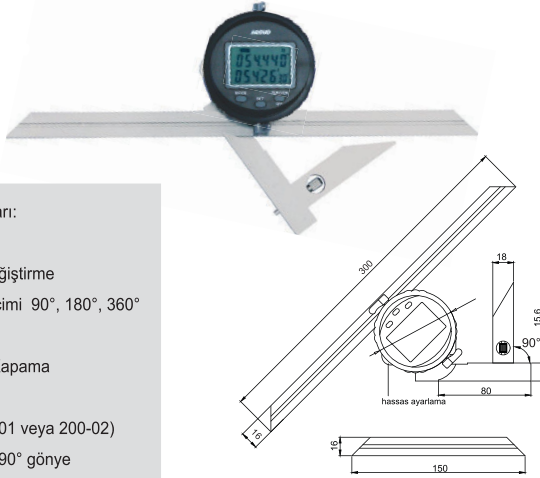

- ◆ Buton fonksiyonları:
SET: Setleme ve
ölçüm yönünü değiştirme
MODE: aralık seçimi 90°, 180°, 360°
ZERO/ON/OFF:
Sıfırlama/Açma/Kapama
- ◆ Veri çıkışı
- ◆ (Kablo kodu:200-01 veya 200-02)
- ◆ 150mm bıçak ve 90° gönye
Paslanmaz çelik

Kod	Aralık	Çözünürlük	Hassasiyet	Fiyat
822-360-01	0 - 360°	0.1°	±0.5'	520 \$

832 SERİSİ

90° KIL GÖNYE

- ◆ İki işlenmiş ölçüm yüzeyi
- ◆ Sertleştirilmiş paslanmaz çelik
- ◆ Krom kaplama

Grade 0

Kod	Boy(LxW)	Diklik(α)	Diklik(β)	a	b	h	Fiyat
832-002-10	50x40mm	6µm	6µm	13	13	4	53 \$
832-003-10	75x50mm	6µm	7µm	15	15	4	56 \$
832-004-10	100x70mm	7µm	7µm	20	20	5	66 \$
832-006-10	150x100mm	7µm	8µm	30	30	6	114 \$
832-008-10	200x130mm	8µm	9µm	34	34	7	134 \$
832-010-10	250x165mm	9µm	10µm	35	35	7	207 \$
832-012-10	300x200mm	10µm	11µm	40	40	8	279 \$

Grade 00

Kod	Boy(LxW)	Diklik(α)	Diklik(β)	a	b	h	Fiyat
832-002-00	50x40mm	2.4µm	2.5µm	13	13	4	57 \$
832-003-00	75x50mm	2.6µm	2.8µm	15	15	4	65 \$
832-004-00	100x70mm	2.8µm	3.0µm	20	20	5	76 \$
832-006-00	150x100mm	3.2µm	3.5µm	30	30	6	131 \$
832-008-00	200x130mm	3.7µm	4.0µm	34	34	7	156 \$
832-010-00	250x165mm	4.2µm	4.5µm	35	35	7	232 \$
832-012-00	300x200mm	4.6µm	5.0µm	40	40	8	321 \$

832-004-00

ACCUD

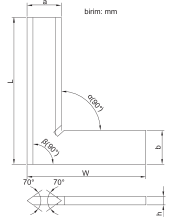

841 SERİSİ

90° DÜZ GÖNYE

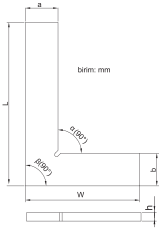

841-004-10

ACCUD

- ◆ DIN875 grade 0
- ◆ Sertleştirilmiş paslanmaz çelik

Kod	Boy(LxW)	Diklik(α)	Diklik(β)	a	b	h	Fiyat
841-002-10	50x40mm	6µm	6µm	13	13	4	45 \$
841-003-10	75x50mm	6µm	7µm	15	15	4	51 \$
841-004-10	100x70mm	7µm	7µm	20	20	5	58 \$
841-006-10	150x100mm	7µm	8µm	30	30	6	88 \$
841-008-10	200x130mm	8µm	9µm	34	34	7	112 \$
841-010-10	250x165mm	9µm	10µm	35	35	7	159 \$
841-012-10	300x200mm	10µm	11µm	40	40	8	192 \$

842 SERİSİ

90° ŞAPKALI GÖNYE

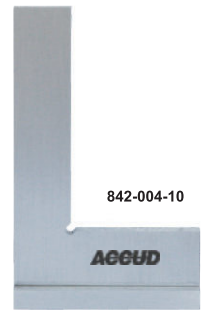
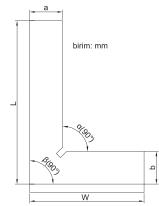

842-004-10

ACCUD

- ◆ DIN875 grade 0
- ◆ Sertleştirilmiş paslanmaz çelik

Kod	Boy(LxW)	Diklik(α)	Diklik(β)	a	b	c	h	Fiyat
842-002-10	50x40mm	6µm	6µm	13	13	13	4	64 \$
842-003-10	75x50mm	6µm	6µm	15	15	15	4	69 \$
842-004-10	100x70mm	7µm	7µm	20	20	20	5	79 \$
842-006-10	150x100mm	7µm	7µm	30	30	30	6	123 \$
842-008-10	200x130mm	8µm	8µm	34	34	30	7	162 \$
842-010-10	250x165mm	9µm	9µm	35	35	35	7	203 \$
842-012-10	300x200mm	10µm	10µm	40	40	40	8	272 \$

843 SERİSİ

90° GENİŞ TABANLI DÜZ GÖNYE

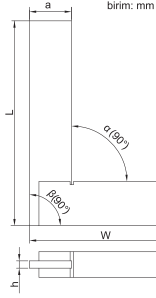

- ◆ DIN875 grade 0
- ◆ Sertleştirilmiş paslanmaz çelik

Kod	Boy(LxW)	Diklik(α)	Diklik(β)	a	b	c	h	Fiyat
843-002-10	50x40mm	6 μ m	6 μ m	12	12	10	3	62 \$
843-003-10	75x50mm	6 μ m	6 μ m	14	14	10	3	70 \$
843-004-10	100x70mm	7 μ m	7 μ m	18	18	10	3	86 \$
843-006-10	150x100mm	7 μ m	7 μ m	22	22	12	4	127 \$
843-008-10	200x130mm	8 μ m	8 μ m	25	25	12	4	166 \$

845 SERİSİ

GENİŞ TABANLI MAKİNACI GÖNYESİ



- ◆ DIN875 grade 2
- ◆ Karbon çelik

Kod	Boy(LxW)	Diklik(α)	Diklik(β)	a	b	c	h	Fiyat
845-002-02	50x40mm	24 μ m	25 μ m	16	12	9	3	21 \$
845-003-02	75x50mm	26 μ m	28 μ m	16	16	9	3	22 \$
845-004-02	100x70mm	28 μ m	30 μ m	19	19	12	3	26 \$
845-006-02	150x100mm	33 μ m	35 μ m	25	25	16	3	35 \$
845-008-02	200x130mm	37 μ m	40 μ m	30	32	16	4	41 \$
845-010-02	250x165mm	42 μ m	45 μ m	30	32	19	4	49 \$
845-012-02	300x200mm	47 μ m	50 μ m	32	32	19	4	80 \$
845-016-02	400x250mm	56 μ m	60 μ m	38	38	22	5	130 \$
845-020-02	500x300mm	65 μ m	70 μ m	45	50	25	6	195 \$
845-024-02	600x350mm	75 μ m	80 μ m	50	50	30	6	285 \$
845-030-02	750x400mm	90 μ m	95 μ m	55	55	50	6	360 \$

847 SERİSİ

60° GÖNYE

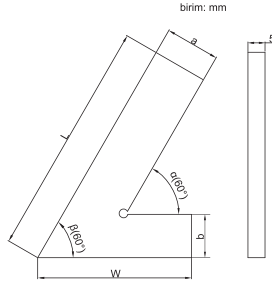

847-004-02

- ◆ Sertleştirilmiş paslanmaz çelik

Kod	Boy(LxW)	Diklik(α)	Diklik(β)	a	b	Fiyat
847-004-02	100x70mm	28 μ m	30 μ m	20	20	42 \$
847-005-02	120x80mm	30 μ m	32 μ m	20	20	52 \$
847-006-02	150x100mm	32 μ m	35 μ m	20	20	60 \$
847-008-02	200x130mm	37 μ m	40 μ m	25	25	81 \$

848 SERİSİ

120° GÖNYE

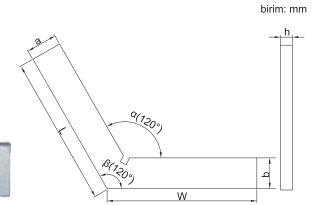

848-004-02

- ◆ Sertleştirilmiş paslanmaz çelik

Kod	Boy(LxW)	Diklik(α)	Diklik(β)	a	b	h	Fiyat
848-002-02	50x50mm	24 μ m	25 μ m	15	15	13	28 \$
848-003-02	75x75mm	26 μ m	28 μ m	20	20	15	32 \$
848-004-02	100x100mm	29 μ m	30 μ m	20	20	20	40 \$
848-006-02	150x150mm	34 μ m	35 μ m	25	25	30	53 \$
848-008-02	200x200mm	38 μ m	40 μ m	30	30	30	68 \$

849 SERİSİ

120° ŞAPKALI GÖNYE

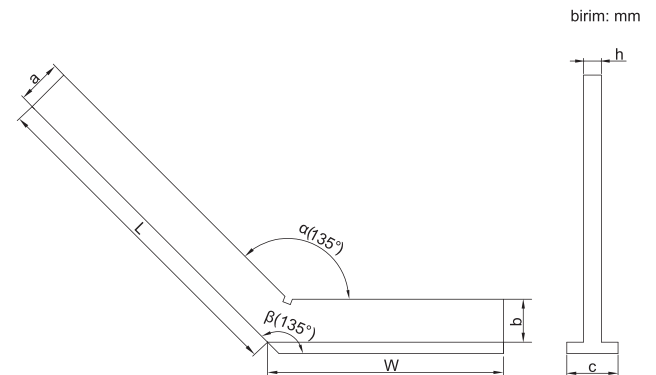

849-005-02

- ◆ Sertleştirilmiş paslanmaz çelik

Kod	Boy(LxW)	Diklik(α)	Diklik(β)	a	b	c	h	Fiyat
849-004-02	100x70mm	29 μ m	31 μ m	20	20	20	5	45 \$
849-005-02	120x80mm	31 μ m	33 μ m	20	20	20	5	50 \$
849-006-02	150x100mm	34 μ m	36 μ m	20	20	20	5	60 \$
849-008-02	200x130mm	39 μ m	41 μ m	30	30	30	7	92 \$