

210 SERİSİ

DİJİTAL KOMPARATÖR SAATI

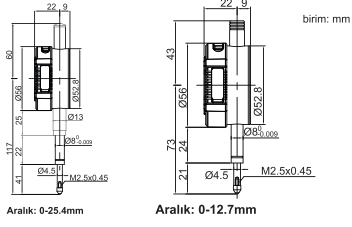

- Butonlar: tolerans girişi, setleme, inch/mm çevrimi, ölçüm yönü, max./min./range, absolute/incremental ölçüm
- Veri çıkışı (Kablo kodu: 200-03 veya 200-04)
- Otomatik kapanma
- Düz ve kulaklı kapak dahil

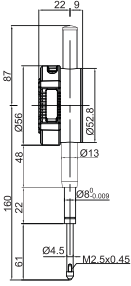

Kod	Aralık	Çözünürlük	Hassasiyet	Histerizis	Fiyat
210-010-03	12.7mm/0.5"	0.001mm/0.00005"	5µm	2µm	278 \$
210-025-03	25.4mm/1"	0.001mm/0.00005"	5µm	3µm	400 \$
210-050-03	50.8mm/2"	0.001mm/0.00005"	6µm	3µm	595 \$
210-010-13	12.7mm/0.5"	0.01mm/0.0005"	20µm	10µm	150 \$
210-025-13	25.4mm/1"	0.01mm/0.0005"	20µm	10µm	207 \$
210-050-13	50.8mm/2"	0.01mm/0.0005"	30µm	10µm	485 \$

211 SERİSİ

DİJİTAL KOMPARATÖR SAATI

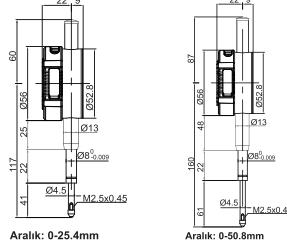

- Analog göstergeli
- Butonlar: tolerans girişi, setleme, inch/mm çevrimi, ölçüm yönü, max./min./range, absolute/incremental ölçüm
- Veri çıkışı (Kablo kodu: 200-03 veya 200-04)
- Otomatik kapanma
- Düz ve kulaklı kapak dahil

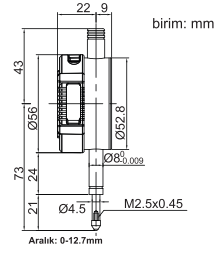

Kod	Aralık	Çözünürlük	Hassasiyet	Histerizis	Fiyat
211-010-03	12.7mm/0.5"	0.001mm/0.00005"	5µm	2µm	320 \$
211-025-03	25.4mm/1"	0.001mm/0.00005"	5µm	3µm	377 \$
211-050-03	50.8mm/2"	0.001mm/0.00005"	6µm	3µm	595 \$
211-010-13	12.7mm/0.5"	0.01mm/0.0005"	20µm	10µm	165 \$
211-025-13	25.4mm/1"	0.01mm/0.0005"	20µm	10µm	225 \$
211-050-13	50.8mm/2"	0.01mm/0.0005"	30µm	10µm	467 \$

212 SERİSİ

DİJİTAL KOMPARATÖR SAATI

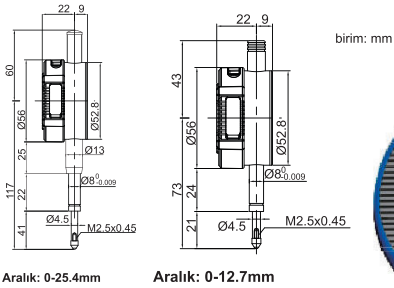

- Butonlar: on/off, sıfırlama setleme, inch/mm çevrimi, ölçüm yönü, absolute/incremental ölçüm
- Veri çıkışı (Kablo kodu: 200-01 veya 200-02)
- Otomatik kapanma
- Düz ve kulaklı kapak dahil

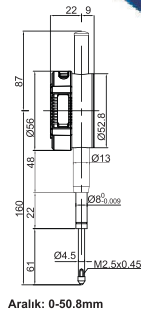

Kod	Aralık	Çözünürlük	Hassasiyet	Histerizis	Fiyat
212-010-03	12.7mm/0.5"	0.001mm/0.00005"	5µm	2µm	247 \$
212-025-03	25.4mm/1"	0.001mm/0.00005"	5µm	3µm	325 \$
212-050-03	50.8mm/2"	0.001mm/0.00005"	6µm	3µm	539 \$
212-010-13	12.7mm/0.5"	0.01mm/0.0005"	20µm	10µm	112 \$
212-025-13	25.4mm/1"	0.01mm/0.0005"	20µm	10µm	177 \$
212-050-13	50.8mm/2"	0.01mm/0.0005"	30µm	10µm	400 \$

213 SERİSİ

SU GEÇİRMEZ DİJİTAL KOMPARATÖR SAATI

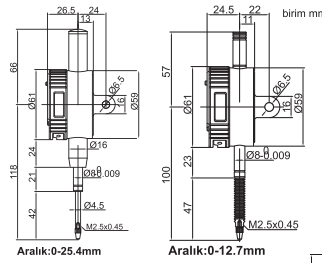

- Toz/su geçirmez
- Butonlar: on/off, zero, inch/mm çevrimi, ölçüm yönü, setleme, absolute/incremental ölçüm
- Otomatik kapanma
- Veri çıkışı (Kablo kodu: 200-01 veya 200-02)
- Düz ve kulaklı kapak

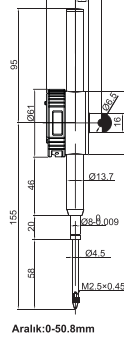

Kod	Aralık	Çözünürlük	Koruma	Hassasiyet	Histerizis	Fiyat
213-010-03	12.7mm/0.5"	0.001mm/0.00005"	IP65	5µm	2µm	390 \$
213-025-03	25.4mm/1"	0.001mm/0.00005"	IP54	5µm	3µm	477 \$
213-050-03	50.8mm/2"	0.001mm/0.00005"	IP54	6µm	3µm	717 \$
213-010-13	12.7mm/0.5"	0.01mm/0.0005"	IP65	20µm	10µm	175 \$
213-025-13	25.4mm/1"	0.01mm/0.0005"	IP54	20µm	10µm	230 \$
213-050-13	50.8mm/2"	0.01mm/0.0005"	IP54	30µm	10µm	527 \$



214 SERİSİ

DİJİTAL KOMPARATÖR SAATI

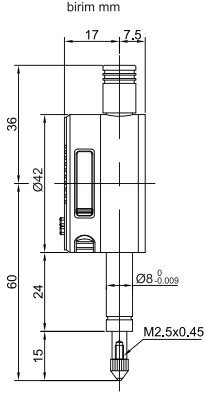

214-005-11

- ◆ Butonlar: on/off, sıfırlama, setleme, inch/mm çevrimi, ölçüm yönü, absolute/incremental ölçüm
- ◆ Veri çıkışı(Kablo kodu:200-01 veya 200-02)
- ◆ Otomatik kapanma
- ◆ Düz ve kulaklı kapak dahil

Kod	Aralık	Çözünürlük	Hassasiyet	Histerezis	Fiyat
214-005-02	5mm/0.2"	0.001mm/0.00005"	9µm	3µm	320 \$
214-005-12	5mm/0.2"	0.01mm/0.0005"	20µm	10µm	152 \$

214 SERİSİ

DİJİTAL KOMPARATÖR SAATI

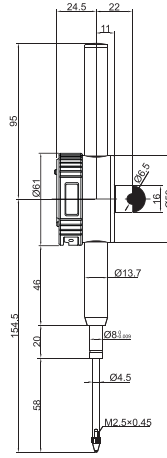

214-100-11

- ◆ Butonlar: on/off, sıfırlama, setleme, inch/mm çevrimi, ölçüm yönü, absolute/incremental ölçüm
- ◆ Veri çıkışı(Kablo kodu:200-01 veya 200-02)
- ◆ Otomatik kapanma
- ◆ Düz ve kulaklı kapak dahil

Kod	Aralık	Çözünürlük	Hassasiyet	Histerezis	Fiyat
214-100-01	100mm/4"	0.001mm/0.00005"	9µm	3µm	1677 \$
214-100-11	100mm/4"	0.01mm/0.0005"	30µm	10µm	897 \$

293 SERİSİ

DİJİTAL DERİNLİK KOMPARATÖRÜ

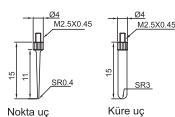
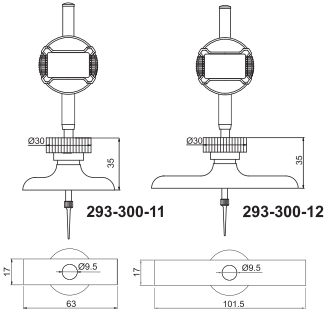

Nokta uç

Küre uç

- ◆ Çözünürlük: 0.01mm/0.0005"
- ◆ Buton: tolerans ayarlama, preset, inch/mm , ölçüm yönü, max./min. /range , absolute/incremental
- ◆ Otomatik kapanma
- ◆ Paslanmaz çelik taban
- ◆ Uzatma milleri: 25mm(1adet), 50mm(1adet), 75mm(1adet), 100mm(2adet)
- ◆ Nokta uç ve küre uç dahil

Kod	Aralık	Hassasiyet	Saat ölçüm aralığı	Taban	Fiyat
293-300-11	0-300mm/0-12"	±0.03mm	25.4mm/1"	63x17mm	285 \$
293-300-12	0-300mm/0-12"	±0.03mm	25.4mm/1"	101.5x17mm	295 \$

291 SERİSİ

MEKANİK DERİNLİK KOMPARATÖRÜ

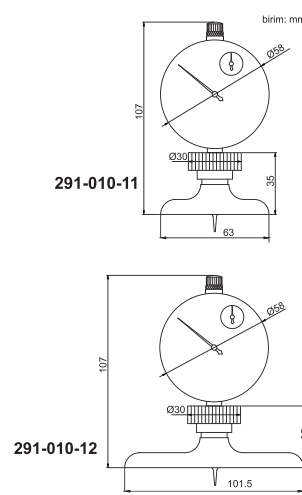

291-010-11

291-010-12



291-010-12

- ◆ Okuma: 0.01mm
- ◆ Saat hareketi: 10mm
- ◆ Hassasiyet: ±0.03mm
- ◆ Paslanmaz çelik taban
- ◆ Nokta ve küre uç dahil

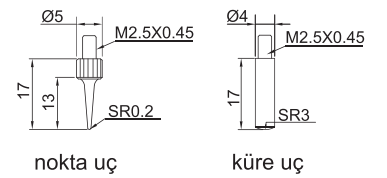

nokta uç

küre uç

Kod	Aralık	Taban	Fiyat
291-010-11	0-10mm	63x17mm	130 \$
291-010-12	0-10mm	101.5x17mm	210 \$



261 SERİSİ

KOMPARATÖR SAATLERİ İÇİN UÇLAR

Kod	Malzeme	L(mm)	Fiyat
270-002-01	çelik	5	9 \$
270-002-02	çelik	10	9 \$
270-002-03	çelik	15	10 \$
270-002-04	çelik	20	11 \$
270-002-05	çelik	25	11 \$
270-002-06	çelik	30	13 \$

Radüs tip uç

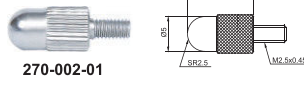

Küresel uç

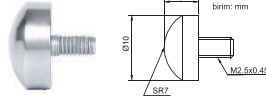

Konik uç

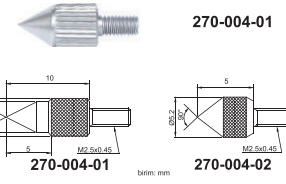

Kod	Malzeme	Fiyat
270-003-01	çelik	12 \$

Kod	Malzeme	Fiyat
270-004-01	çelik	19 \$
270-004-02	çelik	17 \$

Kod	Malzeme	ØD	L	Fiyat
270-006-02	çelik	0.45	5	21 \$
270-006-03	karbür	1	3	40 \$
270-006-04	karbür	1	5	40 \$
270-006-05	karbür	1	8	41 \$
270-006-06	karbür	1	10	43 \$
270-006-07	karbür	1	20	45 \$
270-006-08	karbür	1	40	48 \$
270-006-09	karbür	1.5	5	48 \$
270-006-10	karbür	1.5	10	45 \$
270-006-11	karbür	1.5	13	48 \$
270-006-12	karbür	1.5	20	50 \$
270-006-13	karbür	1.5	40	55 \$
270-006-14	karbür	2	8	43 \$
270-006-15	karbür	2	18	49 \$
270-006-16	karbür	2	28	51 \$
270-006-17	karbür	2	40	55 \$

İğne uç

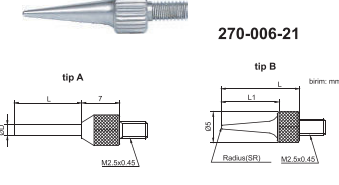

tip B

Kod	Malzeme	L1	L	SR	Fiyat
270-006-21	çelik	11	15	0.4	13 \$
270-006-22	çelik	13	17	0.2	13 \$
270-006-23	çelik	21	25	0.4	19 \$
270-006-24	çelik	31	35	0.4	21 \$

TIP A

Kod	Malzeme	L(mm)	Fiyat
270-001-01	karbür	7.3	8 \$
270-001-02	seramik	7.3	9 \$
270-001-03	karbür	8.3	8 \$
270-001-04	karbür	12.1	8 \$
270-001-05	karbür	14	8 \$
270-001-06	karbür	15	9 \$
270-001-07	seramik	15	10 \$
270-001-08	karbür	17	9 \$
270-001-09	karbür	19.3	10 \$
270-001-10	karbür	20	10 \$
270-001-11	seramik	20	12 \$
270-001-12	karbür	22	10 \$
270-001-13	karbür	25	11 \$
270-001-14	seramik	25	12 \$
270-001-15	karbür	30	11 \$
270-001-16	seramik	30	13 \$

Nokta uç



tip A

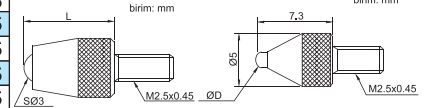

TIP B

Kod	Malzeme	ØD(mm)	Fiyat
270-001-21	çelik	1	7 \$
270-001-22	karbür	1.5	8 \$
270-001-23	karbür	1.8	8 \$
270-001-24	karbür	2.5	7 \$
270-001-25	karbür	4	7 \$

tip A

Kod	Malzeme	L	Fiyat
270-005-01	çelik	8	32 \$
270-005-02	çelik	10	36 \$

tip B

Kod	Malzeme	ØD	Fiyat
270-005-11	çelik	10	33 \$
270-005-12	çelik	15	40 \$
270-005-13	çelik	20	47 \$
270-005-14	çelik	25	49 \$
270-005-15	çelik	30	55 \$

tip C

Kod	Malzeme	Fiyat
270-005-21	karbür	36 \$

Düz uç



Kod	Malzeme	Fiyat
270-007-01	çelik	12 \$

Kod	Malzeme	D	W	Fiyat
270-008-01	çelik	0.4	2	20 \$
270-008-02	çelik	0.6	2	22 \$
270-008-03	çelik	1	4	26 \$

tip A

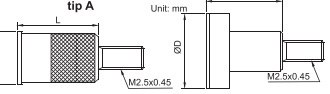

Bıçak ağızlı uç



Bıçak uç

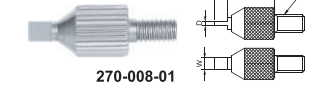

270 SERİSİ

KOMPARATÖR SAATLERİ İÇİN UZATMA

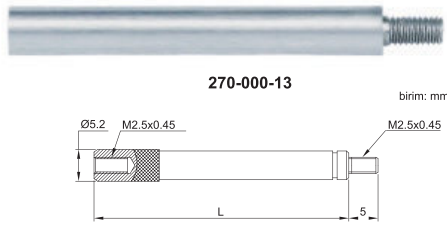

Kod	Malzeme	L	Fiyat
270-000-01	çelik	10	7 \$
270-000-02	çelik	15	7 \$
270-000-03	çelik	20	7 \$
270-000-04	çelik	25	7 \$
270-000-05	çelik	30	7 \$
270-000-06	çelik	35	7 \$
270-000-07	çelik	40	7 \$
270-000-08	çelik	45	7 \$
270-000-09	çelik	50	9 \$

Kod	Malzeme	L	Fiyat
270-000-10	çelik	55	9 \$
270-000-11	çelik	60	9 \$
270-000-12	çelik	65	10 \$
270-000-13	çelik	70	10 \$
270-000-14	çelik	75	10 \$
270-000-15	çelik	80	10 \$
270-000-16	çelik	90	11 \$
270-000-17	çelik	10	11 \$

267 SERİSİ

KOMPARATÖRLER İÇİN BAĞLANTI APARATI



Kod	Kesit boyu	Boy(L)	Fiyat
267-050-01	9x9mm	50mm	22 \$
267-100-01	9x9mm	100mm	23 \$
267-115-02	Ø8mm	115mm	24 \$