

## 611 SERİSİ

## GRANİT PLEYT

- ◆ Hassas taşlanmış granit
- ◆ Kalibrasyon sertifikası
- ◆ Özel ölçüler temin edilir

### Grade 0

Kod	Ölçü(LxWxH)	Düzlemsellik	Ağırlık(Kg)
611-032-10	300x200x60mm	5.4µm	11
611-042-10	400x250x60mm	5.9µm	18
611-044-10	400x400x60mm	6.3µm	29
611-053-10	500x315x70mm	6.4µm	33
611-064-10	630x400x80mm	7.0µm	60
611-066-10	630x630x100mm	7.6µm	119
611-085-10	800x500x100mm	7.8µm	120
611-106-10	1000x630x140mm	8.7µm	265
611-101-10	1000x1000x150mm	9.7µm	450



### Grade 00

Kod	Ölçü(LxWxH)	Düzlemsellik	Ağırlık(Kg)
611-032-00	300x200x60mm	2.7µm	11
611-042-00	400x250x60mm	2.9µm	18
611-044-00	400x400x60mm	3.1µm	29
611-053-00	500x315x70mm	3.2µm	33
611-064-00	630x400x80mm	3.5µm	60
611-066-00	630x630x100mm	3.8µm	119
611-085-00	800x500x100mm	3.9µm	120
611-106-00	1000x630x140mm	4.4µm	265
611-101-00	1000x1000x150mm	4.8µm	450

## 621 SERİSİ

## GRANİT PLEYT İÇİN STAND

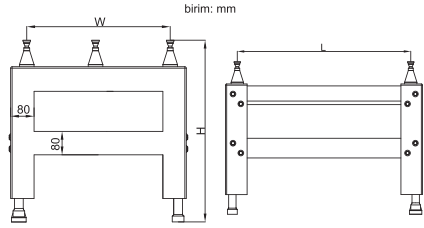

- ◆ Orta ölçü granit pleytler için
- ◆ Kaldırma aralığı: 25mm
- ◆ Farklı yükseklikler yapılabilir

Kod	L	W	H	Granit pleyt
621-064-01	352	224	650-660	630x400x80mm
621-066-01	352	352	685-695	630x630x100mm
621-085-01	448	280	675-685	800x500x100mm
621-106-01	560	352	640-650	1000x630x140mm
621-101-01	560	560	640-650	1000x1000x150mm

## 631 SERİSİ

## GRANİT V-BLOK

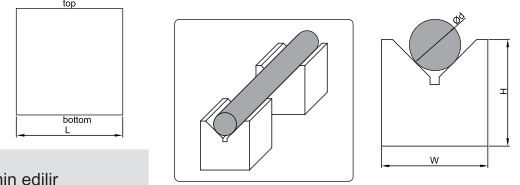
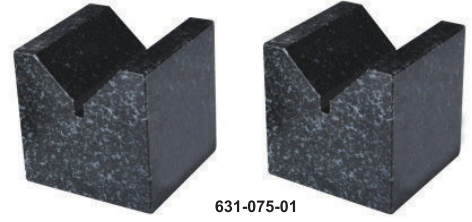

- ◆ Çift olarak temin edilir

Kod	Ölçü(LxWxH)	Çap Aralığı(Ød)	Alt ve üst, sağ ve sol paralellliği	Çift arasında yükseklik farkı	Fiyat
631-075-01	50x70x70mm	6 - 75mm	5µm	5µm	563,32 \$
631-099-01	50x100x70mm	6 - 99mm	5µm	5µm	799,72 \$

## 632 SERİSİ

## V-BLOK SETİ

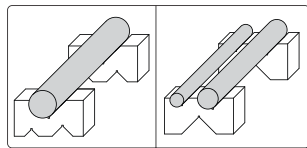
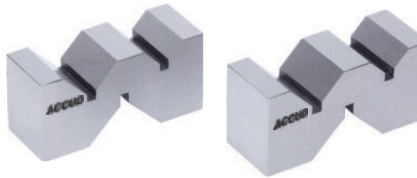
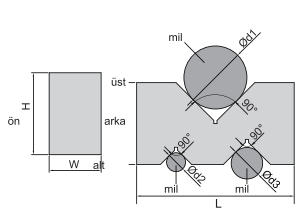

- ◆ Her sette iki V blok
- ◆ Sertleştirilmiş çelik

Kod	Ölçü (LxWxH)	Çap aralığı(Ød1)	Çap aralığı(Ød2)	Çap aralığı(Ød3)	V yatağı paralellliği	V yatağı dikliği	Yükseklik farkı	Fiyat
632-002-01	50x19x24	3 - 32	3 - 16	3 - 22	5µm	5µm	5µm	140 \$
632-003-01	75x24x35	3 - 50	3 - 20	3 - 32	5µm	5µm	5µm	207 \$
632-004-01	100x33x52	3 - 68	3 - 26	3 - 40	5µm	5µm	5µm	255 \$
632-006-01	150x50x80	6 - 100	5 - 40	5 - 60	5µm	5µm	5µm	427 \$

## 633 SERİSİ

## MANYETİK V-BLOK

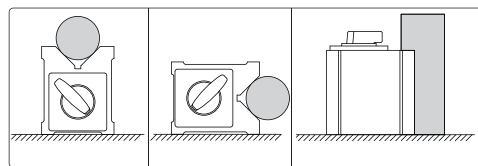
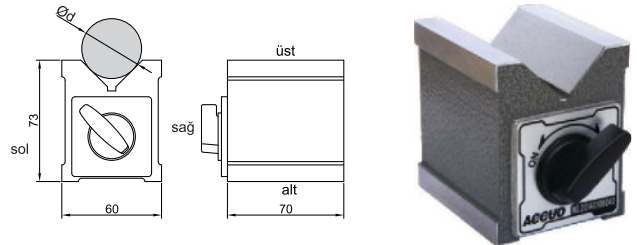

Kod	Çap aralığı(Ød)	Manyetik kuvvet	Paralellik	Diklik	Fiyat
633-044-01	6 - 44mm	56kgf	10µm	10µm	121 \$



## 634 SERİSİ MANYETİK V-BLOK

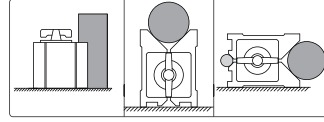
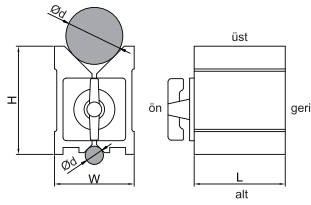

- ◆ Üst yatak büyük çaplar için
- ◆ Alt yatakküçük çaplar için

Kod	Ölçü(LxWxH)	Çap aralığı (Ød)	Manyetik Kuvvet	V-Yatak dikliği	Paralellik	Fiyat
634-067-01	80x70x95mm	6 - 67mm	64kgf	10µm	10µm	195 \$
634-067-02	100x70x95mm	6 - 67mm	80kgf	10µm	10µm	207 \$
634-067-03	120x70x95mm	6 - 67mm	96kgf	10µm	10µm	219 \$

## 636 SERİSİ V-BLOK SETİ

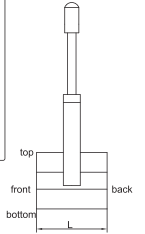
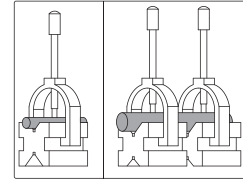

- ◆ Her set için iki V-blok
- ◆ Üst yatak büyük çaplar için
- ◆ Alt yatak küçük çaplar için

Kod	Ölçü(LxWxH)	Çap aralığı (Ød)	Yükseklik farklı	V yatak paralellığı	V yatak dikliği	Fiyat
636-045-01	45x41x35mm	5 - 40mm	5µm	5µm	5µm	179 \$
636-070-01	70x63x44mm	7 - 60mm	5µm	5µm	5µm	246 \$
636-125-01	125x90x70mm	7 - 90mm	5µm	5µm	5µm	516 \$

## 637 SERİSİ V-BLOK SETİ

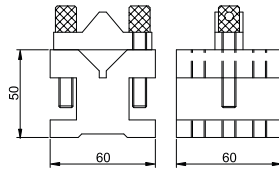

637-035-01

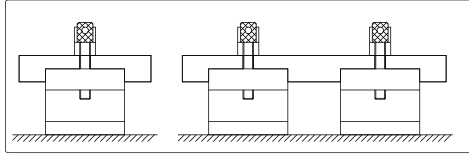

- ◆ Her set için iki V-blok
- ◆ Üst yatak büyük çaplar için

Kod	Ölçü(LxWxH)	Çap aralığı (Ød)	V yatak paralellığı	V yatak dikliği	Yükseklik farklı	Fiyat
637-035-01	35x35x30mm	3 - 16mm	5µm	5µm	5µm	217 \$
637-060-01	60x60x50mm	5 - 34mm	5µm	5µm	5µm	287 \$
637-105-01	105x105x78mm	8 - 66mm	5µm	5µm	5µm	577 \$

## 638 SERİSİ V-BLOK SETİ

Uygulama

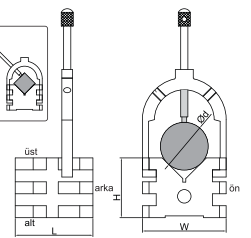
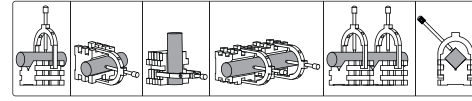

- ◆ Her set için iki V-blok
- ◆ Sertlik HRC60±2
- ◆ Kullanılabilecek çap (Ød): 5 - 50mm
- ◆ Dikey parçalar için kalınlık: ≤35mm

Kod	Ölçü(LxWxH)	V yatak paralellığı	V yatak dikliği	Yükseklik farklı	Fiyat
638-070-01	60x70x50mm	8µm	8µm	8µm	217 \$

## 640 SERİSİ V-BLOK

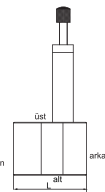
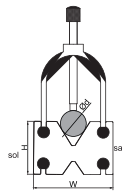

- ◆ Sertlik HRC60

Kod	Ölçü (LxWxH)	Çap aralıkları (Ød1 ve Ød2)	V yatak paralellığı	V yatak dikliği	Yan V yatak paralellığı	Fiyat
640-001-01	65x70x45mm	4-35mm	5µm	5µm	5µm	247 \$

## 646 SERİSİ ÜNİVERSAL AÇI PLEYT SETİ

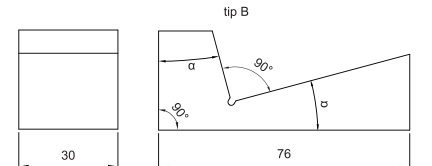
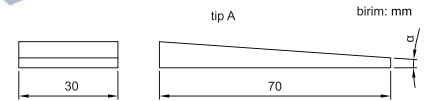
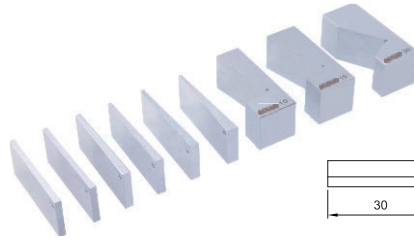

- ◆ Sertlik HRC55

Kod	Adet	Açı α	Tip	Hassasiyet	Fiyat
646-009-01	9pcs	½°, 1°, 2°, 3°, 4°, 5°, 10°, 15°, 30°	tip A tip B	±1'	247 \$

## 642 SERİSİ GRANİT CETVEL

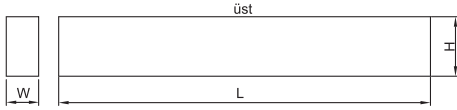

Kod	Boy(L)	Düzlemsellik	W	H	Fiyat
642-020-01	500mm	2.8µm	50	80	708 \$
642-040-01	1000mm	3.3µm	60	120	1224 \$

## 643 SERİSİ GRANİT GÖNYE

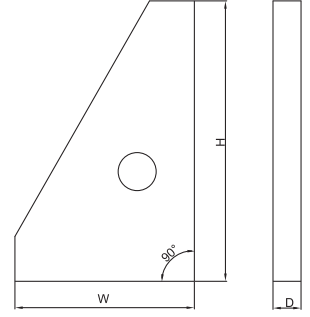

643-010-01

Kod	Ölçü(HxW)	Diklik	D	Fiyat
643-010-01	250x160mm	2.5µm	25mm	471,16 \$
643-016-01	400x250mm	3.5µm	40mm	659,48 \$
643-024-01	630x400mm	4.5µm	63mm	1721,08 \$

## 644 SERİSİ GRANİT GÖNYE

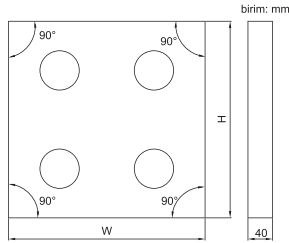

Kod	Ölçü(HxW)	Diklik	Fiyat
644-012-01	315x315mm	2.6µm	1247,44 \$

## 645 SERİSİ GRANİT GÖNYE VE V-BLOK

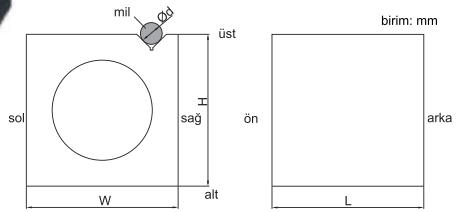

◆ Delik dişi: M8

Kod	Ölçü(LxWxH)	Çap aralığı (Ød)	Gönye dikliği	V yatak paralellliği	V yatak dikliği	Fiyat
645-006-01	160x160x160mm	6 - 42mm	8µm	8µm	8µm	1787 \$

## 651 SERİSİ SİNÜSBAR

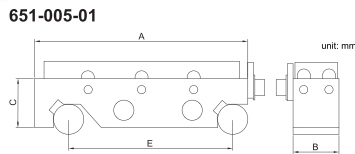

◆ Sertleştirilmiş çelik alaşımı

Kod	Silindirlere arası mesafe(E)	Tabla ölçüsü (AxB)	30° de α hassasiyeti	C	Fiyat
651-005-01	100mm	130x25mm	±8"	25mm	225 \$
651-005-02	100mm	130x83mm	±16"	30mm	525 \$
651-010-01	200mm	250x40mm	±8"	40mm	504 \$
651-010-02	200mm	250x85mm	±16"	40mm	635 \$

## 692 SERİSİ IŞIKLI PROB

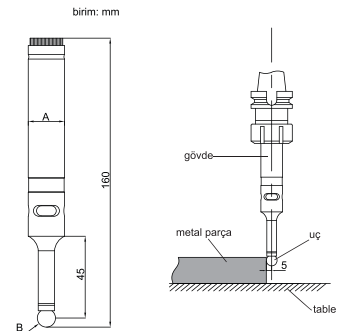

Kod	UÇ(B)	Gövde(A)	Hassasiyet	Fiyat
692-010-01	SØ10mm	Ø20mm	5µm	110 \$