

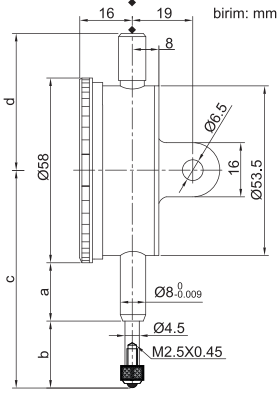

221 SERİSİ

MEKANİK KOMPARATÖR SAATI



221-001-01

- ♦ Okuma: 0.001mm
- ♦ Limit göstergeli
- ♦ Her tur: 0,2mm
- ♦ Düz ve kulaklı kapak dahil

Kod	Aralık	Skala	Hassasiyet	Histerezis	237 \$	b	c	d	Fiyat
221-001-01	1mm	0-200	5µm	2µm	15	19.5	62.5	45	154 \$
221-003-01	3mm	0-200	10µm	4µm	10	21.5	59.5	41.5	244 \$
221-005-01	5mm	0-200	10µm	4µm	10	21.5	59.5	41.5	275 \$

222 SERİSİ

MEKANİK KOMPARATÖR SAATI

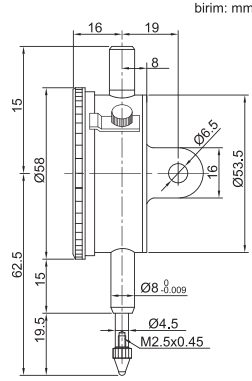

222-001-01

- ♦ Okuma: 0.001mm
- ♦ Limit göstergeli
- ♦ Her tur: 0,2mm
- ♦ Kilitleme vidalı

Kod	Aralık	Kapak	Skala	Hassasiyet	Histerezis	Fiyat
222-001-01	1mm	kulaklı	0-100-0	5µm	2µm	105 \$
222-001-02	1mm	düz	0-100-0	5µm	2µm	102 \$

223 SERİSİ

MEKANİK KOMPARATÖR SAATI

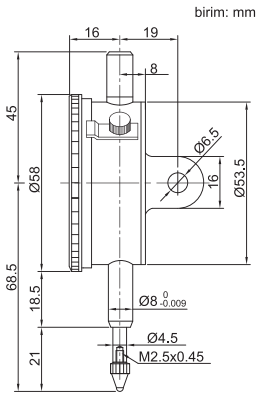

223-010-11

- ♦ Okuma: 0.01mm
- ♦ Limit göstergesi
- ♦ Her tur: 1mm
- ♦ Kilitleme vidalı

Kod	Aralık	Kapak	Hassasiyet	Skala	Histerezis	Fiyat
223-010-11	10mm	Kulaklı	20µm	0-100	3µm	33 \$
223-010-12	10mm	Düz	20µm	0-100	3µm	33 \$

222 SERİSİ

MEKANİK KOMPARATÖR SAATI

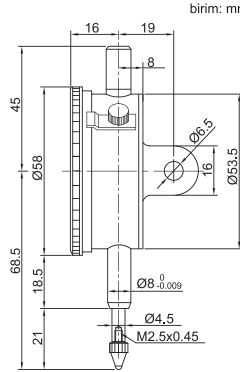

222-010-11

- ♦ Okuma: 0.01mm
- ♦ Limit göstergeli
- ♦ Her tur: 1mm
- ♦ Kilitleme vidalı

Kod	Aralık	Kapak	Hassasiyet	Skala	Histerezis	Fiyat
222-003-11	3mm	kulaklı	14µm	0-100	3µm	53 \$
222-005-11	5mm	kulaklı	16µm	0-100	3µm	53 \$
222-010-11	10mm	kulaklı	20µm	0-100	3µm	46 \$
222-003-12	3mm	düz	14µm	0-100	3µm	50 \$
222-005-12	5mm	düz	16µm	0-100	3µm	53 \$
222-010-12	10mm	düz	20µm	0-100	3µm	43 \$

225 SERİSİ

MEKANİK KOMPARATÖR SAATI

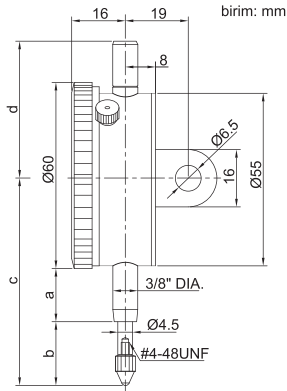

225-025-11

- Limit göstergesi
- Kulaklı kapak

Kod	Aralık	Okuma	Saat okuma	Aralık/tur	Hassasiyet(f/ges)	a	b	c	d	Fiyat
225-006-11	0.25"	0.001"	0-100	0.1"	0.004"	23	25	75	46	55 \$
225-012-11	0.5"	0.001"	0-100	0.1"	0.004"	20	25	75	46	55 \$
225-025-11	1"	0.001"	0-100	0.1"	0.004"	20	35	85	46	77 \$
225-050-11	2"	0.001"	0-100	0.1"	0.008"	50	59	139	111	107 \$

226 SERİSİ

MEKANİK KOMPARATÖR SAATI

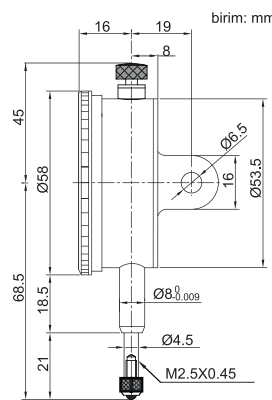

226-010-11

- Darbeye dayanıklı
- Okuma: 0.01mm
- Limit göstergeli
- Her tur: 1mm
- Düz ve kulaklı kapak dahil

Kod	Aralık	Hassasiyet	Histerizis	Skala	Fiyat
226-005-11	5mm	16µm	3µm	0-100	77 \$
226-010-11	10mm	20µm	3µm	0-100	72 \$

228 SERİSİ

MEKANİK KOMPARATÖR SAATI

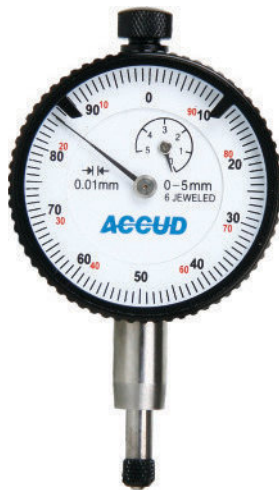
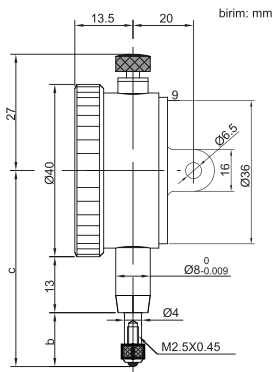

228-005-11

- Saat çapı: Ø40mm
- Okuma: 0.01mm
- Limit göstergeli
- Her tur: 1mm
- Düz ve kulaklı kapak dahil

Kod	Aralık	Hassasiyet	Histerizis	Skala	b	c	Fiyat
228-003-11	3mm	14µm	3µm	0-100	11mm	44mm	67 \$
228-005-11	5mm	16µm	3µm	0-100	12.5mm	45.5mm	68 \$

229 SERİSİ

MEKANİK KOMPARATÖR

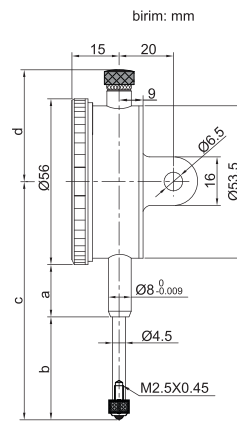

229-030-11

- Okuma: 0.01mm
- Limit göstergeli
- Her tur: 1mm
- Düz ve kulaklı kapak dahil

Kod	Aralık	Hassasiyet	Histerizis	Skala	a	b	c	d	Fiyat
229-020-11	20mm	25µm	5µm	0-100	20mm	35mm	83mm	37.5mm	95 \$
229-030-11	30mm	35µm	7µm	0-100	20mm	40mm	88mm	37.5mm	96 \$
229-050-21	50mm	40µm	8µm	0-100	40mm	58mm	127mm	108mm	185 \$
229-100-21	100mm	50µm	9µm	0-100	60mm	108mm	207mm	168mm	482 \$



261 SERİSİ SALGI KOMPARATÖRÜ

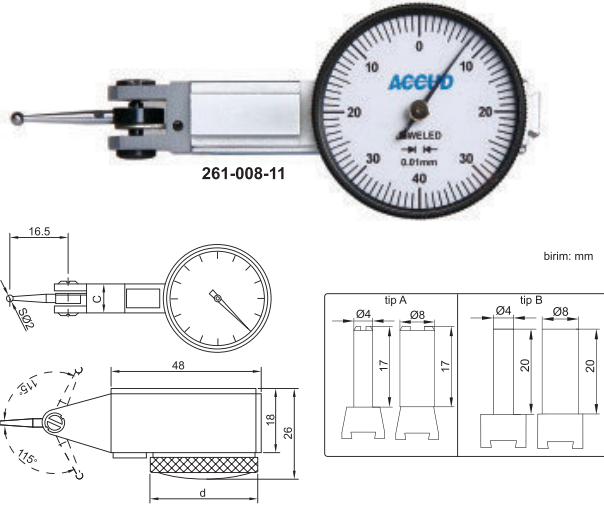

- ◆ Anti-manyetik bakır gövde
- ◆ Bağlantı aparatı: Ø4mm ve Ø8mm

Kod	Aralık	Gövde(d)	Okuma	Uç	Kilitleme	Hassasiyet	Histerezis	Skala	C	Fiyat
261-008-11	0.8mm	Ø30mm	0.01mm	karbür	tip A	13µm	3µm	0-40-0	8.9mm	75 \$
261-008-12	0.8mm	Ø37.5mm	0.01mm	karbür	tip A	13µm	3µm	0-40-0	8.9mm	84 \$
261-002-01	0.2mm	Ø30mm	0.002mm	yakut	tip B	6µm	2µm	0-100-0	8mm	127 \$
261-002-02	0.2mm	Ø37.5mm	0.002mm	yakut	tip B	6µm	2µm	0-100-0	8mm	140 \$

263 SERİSİ UZUN UÇLU SALGI KOMPARATÖRÜ

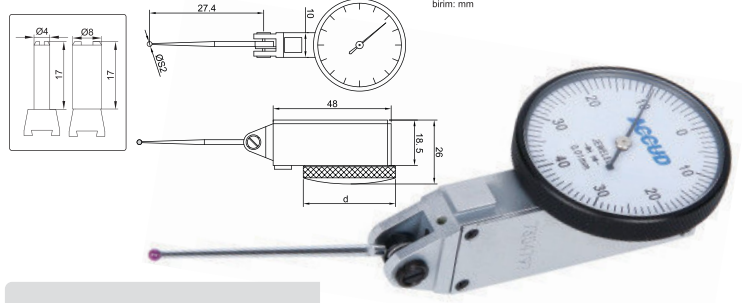

- ◆ Anti-manyetik bakır gövde
- ◆ Bağlantı aparatı: Ø4mm and Ø8mm

Kod	Aralık	Çerçeve(d)	Okuma	Uç	Hassasiyet	Histerezis	Cetvel	Fiyat
263-008-11	0.8mm	Ø37.5mm	0.01mm	karbür	13µm	3µm	0-40-0	155 \$

260 SERİSİ SALGI KOMPARATÖRÜ İÇİN UÇ

(261-008-11 ve 261-008-12 için)



- ◆ 261 serisi için uç

Kod	Uç malzemesi	D(mm)	Fiyat
260-001-01	çelik	SØ1	11 \$
260-002-02	karbür	SØ2	11 \$
260-003-02	karbür	SØ3	14 \$
260-010-01	Yakut	SØ2	16 \$

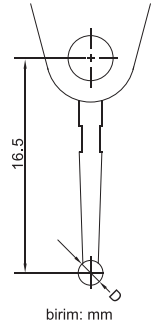

232 SERİSİ TEK TUR MEKANİK KOMPARATÖR SAATI

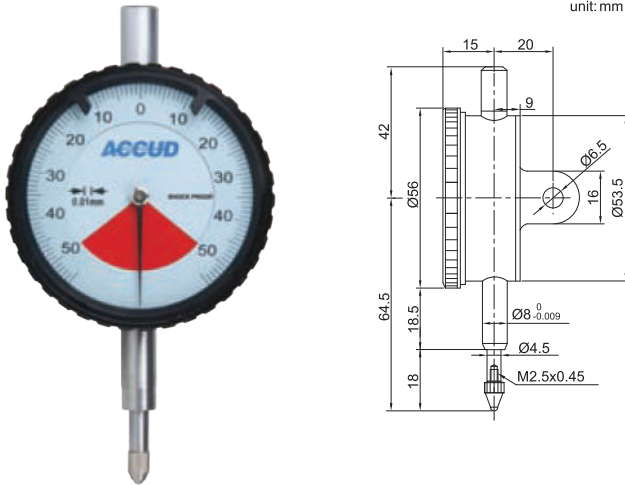

- ◆ Darbeye dayanıklı

Kod	Aralık	Çözünürlük	Hassasiyet	Histerezis	Skala	Fiyat
232-0005-11	0.5mm	0.01mm	9µm	3µm	25-0-25	85 \$
232-001-11	1mm	0.01mm	9µm	3µm	50-0-50	90 \$

231 SERİSİ SU GEÇİRMEZ MEKANİK KOMPARATÖR

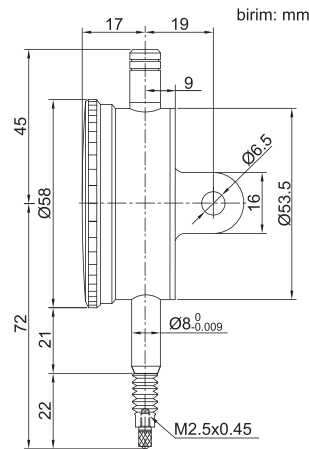

- ◆ IP54 toz/su koruması
- ◆ Okuma:0.01mm

Kod	Aralık	Hassasiyet(f _{ges})	Histerezis(f _u)	Aralık/tur	Saat okuma	Fiyat
231-010-11	10mm	17µm	3µm	1mm	0-100	92 \$





261 SERİSİ KOMPARATÖR SAATLERİ İÇİN UÇLAR

Kod	Malzeme	L(mm)	Fiyat
270-002-01	çelik	5	9 \$
270-002-02	çelik	10	9 \$
270-002-03	çelik	15	10 \$
270-002-04	çelik	20	11 \$
270-002-05	çelik	25	11 \$
270-002-06	çelik	30	13 \$

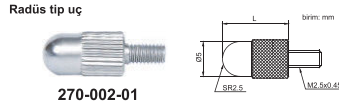

Kod	Malzeme	Fiyat
270-003-01	çelik	12 \$

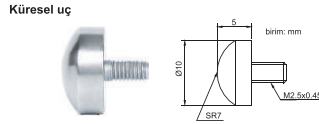

Kod	Malzeme	Fiyat
270-004-01	çelik	19 \$
270-004-02	çelik	17 \$

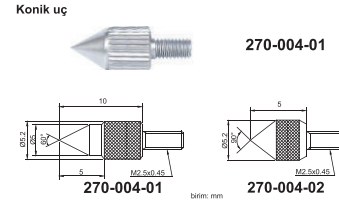

Kod	Malzeme	ØD	L	Fiyat
270-006-02	çelik	0.45	5	21 \$
270-006-03	karbür	1	3	40 \$
270-006-04	karbür	1	5	40 \$
270-006-05	karbür	1	8	41 \$
270-006-06	karbür	1	10	43 \$
270-006-07	karbür	1	20	45 \$
270-006-08	karbür	1	40	48 \$
270-006-09	karbür	1.5	5	48 \$
270-006-10	karbür	1.5	10	45 \$
270-006-11	karbür	1.5	13	48 \$
270-006-12	karbür	1.5	20	50 \$
270-006-13	karbür	1.5	40	55 \$
270-006-14	karbür	2	8	43 \$
270-006-15	karbür	2	18	49 \$
270-006-16	karbür	2	28	51 \$
270-006-17	karbür	2	40	55 \$

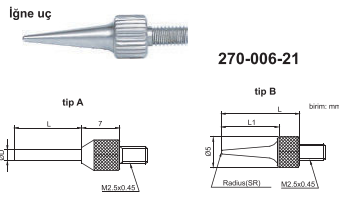

Kod	Malzeme	L1	L	SR	Fiyat
270-006-21	çelik	11	15	0.4	13 \$
270-006-22	çelik	13	17	0.2	13 \$
270-006-23	çelik	21	25	0.4	19 \$
270-006-24	çelik	31	35	0.4	21 \$

Kod	Malzeme	L(mm)	Fiyat
270-001-01	karbür	7.3	8 \$
270-001-02	seramik	7.3	9 \$
270-001-03	karbür	8.3	8 \$
270-001-04	karbür	12.1	8 \$
270-001-05	karbür	14	8 \$
270-001-06	karbür	15	9 \$
270-001-07	seramik	15	10 \$
270-001-08	karbür	17	9 \$
270-001-09	karbür	19.3	10 \$
270-001-10	karbür	20	10 \$
270-001-11	seramik	20	12 \$
270-001-12	karbür	22	10 \$
270-001-13	karbür	25	11 \$
270-001-14	seramik	25	12 \$
270-001-15	karbür	30	11 \$
270-001-16	seramik	30	13 \$

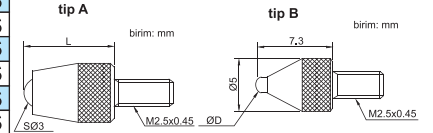

Kod	Malzeme	ØD(mm)	Fiyat
270-001-21	çelik	1	7 \$
270-001-22	karbür	1.5	8 \$
270-001-23	karbür	1.8	8 \$
270-001-24	karbür	2.5	7 \$
270-001-25	karbür	4	7 \$

Kod	Malzeme	L	Fiyat
270-005-01	çelik	8	32 \$
270-005-02	çelik	10	36 \$



Kod	Malzeme	ØD	Fiyat
270-005-11	çelik	10	33 \$
270-005-12	çelik	15	40 \$
270-005-13	çelik	20	47 \$
270-005-14	çelik	25	49 \$
270-005-15	çelik	30	55 \$

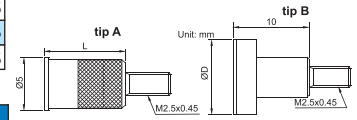

Kod	Malzeme	Fiyat
270-005-21	karbür	36 \$

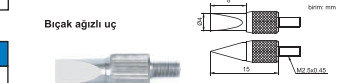

Kod	Malzeme	Fiyat
270-007-01	çelik	12 \$

Kod	Malzeme	D	W	Fiyat
270-008-01	çelik	0.4	2	20 \$
270-008-02	çelik	0.6	2	22 \$
270-008-03	çelik	1	4	26 \$

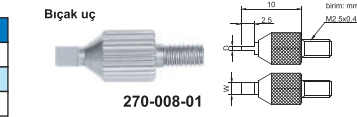

270 SERİSİ KOMPARATÖR SAATLERİ İÇİN UZATMA

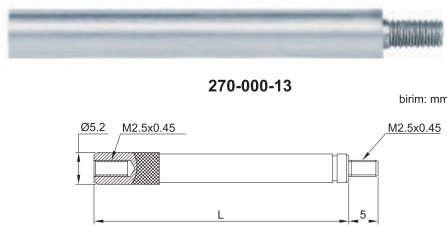

Kod	Malzeme	L	Fiyat
270-000-01	çelik	10	7 \$
270-000-02	çelik	15	7 \$
270-000-03	çelik	20	7 \$
270-000-04	çelik	25	7 \$
270-000-05	çelik	30	7 \$
270-000-06	çelik	35	7 \$
270-000-07	çelik	40	7 \$
270-000-08	çelik	45	7 \$
270-000-09	çelik	50	9 \$

Kod	Malzeme	L	Fiyat
270-000-10	çelik	55	9 \$
270-000-11	çelik	60	9 \$
270-000-12	çelik	65	10 \$
270-000-13	çelik	70	10 \$
270-000-14	çelik	75	10 \$
270-000-15	çelik	80	10 \$
270-000-16	çelik	90	11 \$
270-000-17	çelik	10	11 \$

267 SERİSİ KOMPARATÖRLER İÇİN BAĞLANTI APARATI



Kod	Kesit boyu	Boy(L)	Fiyat
267-050-01	9x9mm	50mm	22 \$
267-100-01	9x9mm	100mm	23 \$
267-115-02	Ø8mm	115mm	24 \$