

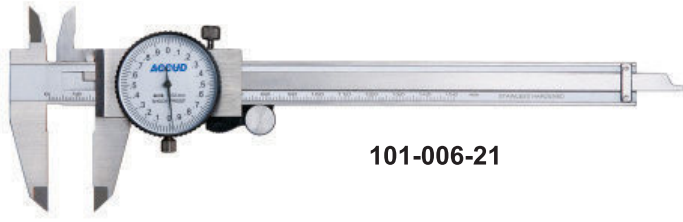

## 101 SERİSİ

## SAATLİ KUMPAS



101-006-21

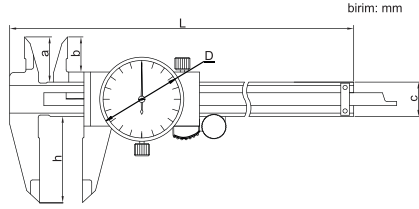

- ◆ Darbeye dayanıklı saat
- ◆ Paslanmaz çelik

Kod	Aralık	Okuma	Hassasiyet	a	b	c	h	D	L	Fiyat
101-006-11	0-150mm	0.01mm	±0.03mm	21	16.5	16	40	Ø39	233	90 \$
101-008-11	0-200mm	0.01mm	±0.03mm	24	19	16	50	Ø39	288	116 \$
101-012-11	0-300mm	0.01mm	±0.04mm	30	25	20	64	Ø44	390	192 \$
101-006-21	0-150mm	0.02mm	±0.03mm	21	16.5	16	40	Ø39	233	76 \$
101-008-21	0-200mm	0.02mm	±0.03mm	24	19	16	50	Ø39	288	103 \$
101-012-21	0-300mm	0.02mm	±0.04mm	30	25	20	64	Ø44	390	180 \$

## 103 SERİSİ

## SAATLİ KUMPAS

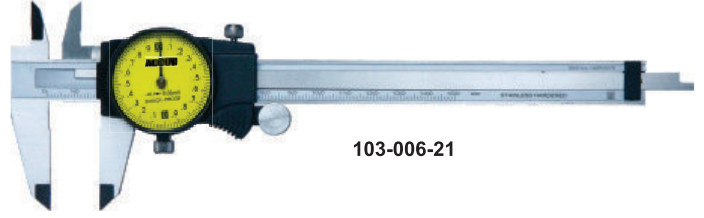

103-006-21

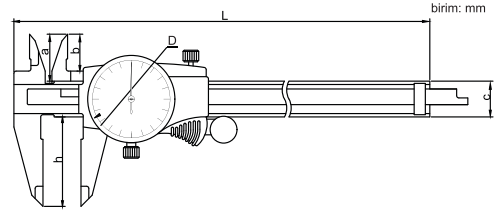

- ◆ Darbeye dayanıklı saat
- ◆ Paslanmaz çelik

Kod	Aralık	Okuma	Hassasiyet	a	b	c	h	D	L	Fiyat
103-006-11	0-150mm	0.01mm	±0.03mm	21	16.5	16	40	Ø39	233	110 \$
103-008-11	0-200mm	0.01mm	±0.03mm	24	19	16	50	Ø3	288	143 \$
103-006-21	0-150mm	0.02mm	±0.03mm	21	16.5	16	40	Ø39	233	99 \$
103-008-21	0-200mm	0.02mm	±0.03mm	24	19	16	50	Ø39	288	131 \$
103-012-21	0-300mm	0.02mm	±0.04mm	30	25	20	64	Ø44	390	207 \$

## 133 SERİSİ

## DİJİTAL DIŞ ÇAP KANAL KUMPASI

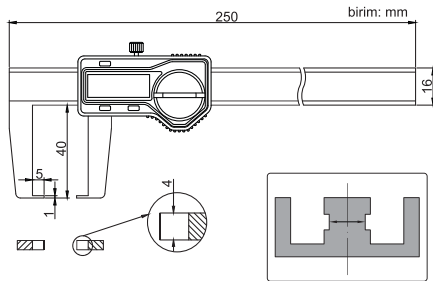
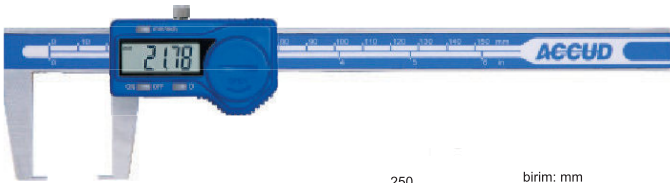

- ◆ Et kalınlığı ve kanal ölçümleri
- ◆ Çözünürlük: 0.01mm/0.0005"
- ◆ Otomatik açma/kapama
- ◆ Butonlar: on/off, zero, mm/inch
- ◆ Veri çıkışı  
(Kablo kodu: 100-11 veya 100-12)
- ◆ Paslanmaz çelik

Kod	Aralık	Hassasiyet	Fiyat
133-006-11	0-150mm/0-6"	±0.04mm	190 \$

## 143 SERİSİ

## MEKANİK DIŞ ÇAP KANAL KUMPASI

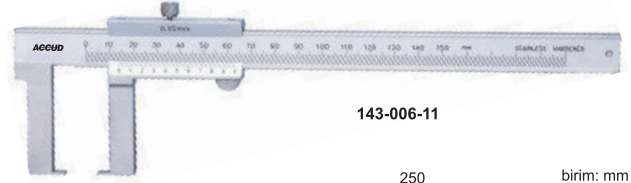

143-006-11

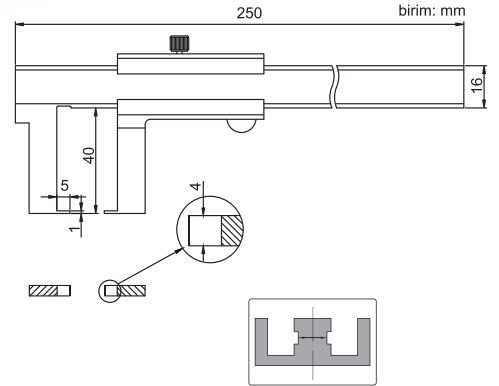

- ◆ Dış çap kanal ölçümü
- ◆ Paslanmaz çelik
- ◆ Krom kaplama okuma yüzeyi

Kod	Aralık	Okuma	Hassasiyet	Fiyat
143-006-11	0-150mm	0.02mm	±0.04mm	195 \$
143-006-13	0-150mm	0.05mm	±0.05mm	190 \$