

Takım Kodu Ordering Code Bestell-Bezeichnung	Stok Stock Lager		Takım Ölçüleri (mm) Dimension (mm) Abmessung (mm)							Kesici Uç Insert Wendeschneidplatte	Yedek Parçaları / Spare Parts / Ersatzteile	
	R	L	DCON	DMIN	LF	OHN	CDX	H	WF		Sıkma Vidası Screw Schraube	Anahtar Allen Key Innenbohrschlüssel
AIKT-K-R/L-16-2-T4	●	●	16	21	150	28	4	14.8	12	MGM. - 2	2503-M4x10	AAL-03-3
AIKT-K-R/L-20-2-T4	●	●	20	25	170	30	4	18.3	14		2503-M4x12	
AIKT-K-R/L-25-2-T6	●	●	25	32	200	40	6	23	18.5		2504-M5x12	
AIKT-K-R/L-20-3-T6	●	●	20	27	170	30	6	18.3	16	MGM. - 3	2504-M5x12	AAL-05-4
AIKT-K-R/L-20-3-T7	●	●	20	25	170	38	7	18.3	13		2504-M5x12	
AIKT-K-R/L-25-3-T6	●	●	25	32	200	40	6	23	18.5		2504-M5x16	
AIKT-K-R/L-25-3-T10	●	●	25	32	200	48	10	23	17		2004-M8x1x20	
AIKT-K-R/L-32-3-T6	●	●	32	39	250	50	6	30	22		2504-M5x12	
AIKT-K-R/L-32-3-T12	●	●	32	39	250	53	12	30	22		2504-M5x16	
AIKT-K-R/L-40-3-T6	●	●	40	47	300	55	6	37.5	26	MGM. - 4	2004-M8x1x20	AAL-05-4
AIKT-K-R/L-40-3-T12	●	○	40	48	300	63	12	37.5	27		2504-M5x12	
AIKT-K-R/L-20-4-T6	●	●	20	27	170	30	6	18.3	16		2504-M5x16	
AIKT-K-R/L-20-4-T7	●	○	20	25	170	38	7	18.3	13		2504-M5x16	
AIKT-K-R/L-25-4-T6	●	●	25	32	200	40	6	23	18.5	MGM. - 5	2504-M5x16	AAL-05-4
AIKT-K-R/L-25-4-T10	●	●	25	32	200	49	10	23	17		2004-M8x1x20	
AIKT-K-R/L-32-4-T6	●	●	32	39	250	50	6	30	22		2504-M5x12	
AIKT-K-R/L-32-4-T12	●	●	32	39	250	53	12	30	22		2504-M5x16	
AIKT-K-R/L-40-4-T6	●	●	40	47	300	55	6	37.5	26	MGM. - 5	2004-M8x1x20	AAL-05-4
AIKT-K-R/L-40-4-T12	●	●	40	48	300	63	12	37.5	27		2504-M5x16	
AIKT-K-R/L-25-5-T7	●	●	25	33	200	40	7	23	19.5		2004-M8x1x20	
AIKT-K-R/L-32-5-T7	●	●	32	40	250	50	7	30	23		2504-M5x12	
AIKT-K-R/L-40-5-T7	●	●	40	48	300	55	7	37.5	27	MGM. - 5	2004-M8x1x20	AAL-05-4
AIKT-K-R/L-40-5-T12	●	○	40	48	300	63	12	37.5	27			

R: Sağ / Right / Rechts L: Sol/Left/Links
● Stokta / In Stock / Auf Lager ○ Stokta Yok / Non Stock Item / Kein Lagerartikel, Lieferzeit auf Anfrage
KRLY Ucuna Uygunudur. / Compatible with KRLY Insert. / Kompatibel mit KRLY Wendeplatten.

Sipariş Örneği/Ordering Example/Bestellbeispiel
1 ad./pcs./stück AIKT-K-R-16-2-T4

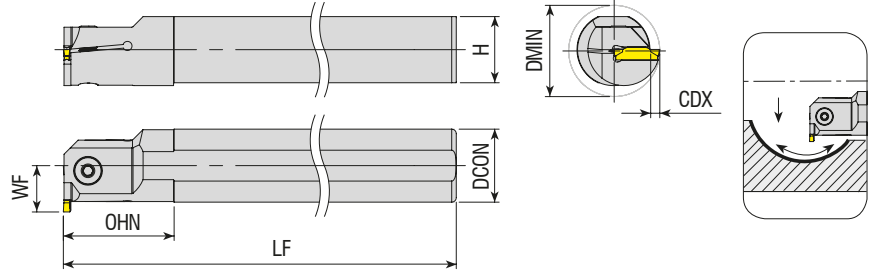

Takım Kodu
Ordering Code
Bestell-Bezeichnung

Stok
Stock
Lager

Takım Ölçüleri (mm)
Dimension (mm)
Abmessung (mm)

Kesici Uç
Insert
Wendeschneidplatte

Yedek Parçaları / Spare Parts / Ersatzteile

Sıkma Vidası
Screw
Schraube

Anahtar
Allen Key
Innensechskantschlüssel

R	L	DCON	DMIN	LF	OHN	CDX	H	WF			
●	●	25	33	200	40	7	23	19.5	KG.. - 2	2504-M5x12	
●	○	20	27.5	170	30	6.5	18.3	16.5	KG.. - 3	2504-M5x16	AAL-05-4
○	○	25	33	200	40	7	23	19.5		2004-M8x1x20	
●	○	40	50	300	55	8	37.5	28	KG.. - 4	2504-M5x16	
●	●	25	34	200	40	8	23	20.5			

KRLY Ucuna Uygundur. / Compatible with KRLY Insert. / Kompatibel mit KRLY Wendeplatten.

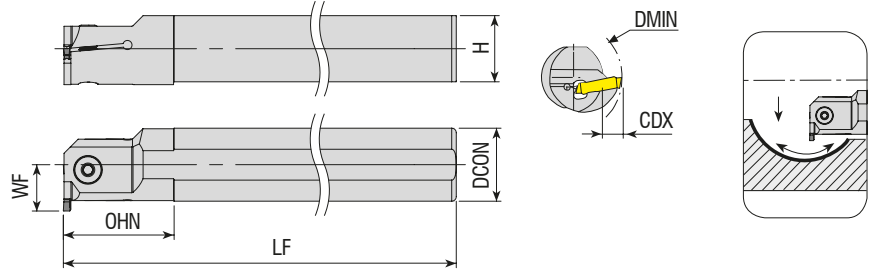

Takım Kodu
Ordering Code
Bestell-Bezeichnung

Stok
Stock
Lager

Takım Ölçüleri (mm)
Dimension (mm)
Abmessung (mm)

Kesici Uç
Insert
Wendeschneidplatte

Yedek Parçaları / Spare Parts / Ersatzteile

Sıkma Vidası
Screw
Schraube

Anahtar
Allen Key
Innensechskantschlüssel

R	L	DCON	DMIN	LF	OHN	CDX	H	WF			
●	●	25	34	200	40	8	23	20.5	S229 - 3	2504-M5x16	AAL-05-4
●	●	32	40	250	50	7	30	23		2004-M8x1x20	
●	●	40	48	300	55	7	37.5	27	S229 - 4	2504-M5x16	AAL-05-4
●	●	25	34	200	40	8	23	20.5		2004-M8x1x20	
●	●	32	40	250	50	7	30	23	S229 - 5	2504-M5x16	AAL-05-4
●	○	40	48	300	55	7	37.5	27		2004-M8x1x20	
●	●	25	34	200	40	8	23	20.5	S229 - 5	2504-M5x16	AAL-05-4
●	○	32	40	250	50	7	30	23		2004-M8x1x20	
●	○	40	48	300	55	7	37.5	27			

R: Sağ / Right / Rechts L: Sol/Left/Links

● Stokta / In Stock / Auf Lager ○ Stokta Yok / Non Stock Item / Kein Lagerartikel, Lieferzeit auf Anfrage
HRN Ucuna Uygundur. / Compatible with HRN Insert. / Kompatibel mit HRN Wendeplatten.

Sipariş Örneği/Ordering Example/Bestellbeispiel
1 ad./pcs./stück Aikt-KG-R-25-2-T7

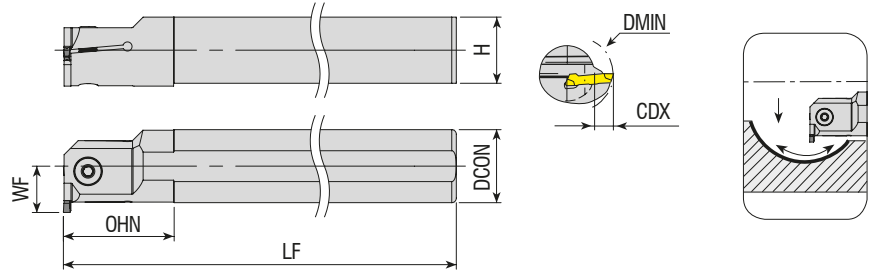

Takım Kodu Ordering Code Bestell-Bezeichnung	Stok Stock Lager		Takım Ölçüleri (mm) Dimension (mm) Abmessung (mm)							Kesici Uç Insert Wendeschneidplatte	Yedek Parçaları / Spare Parts / Ersatzteile	
	R	L	DCON	DMIN	LF	OHN	CDX	H	WF		Sıkma Vidası Screw Schraube	Anahtar Allen Key Innenschlüssel
AIKT-HK-R/L-20-2-T6	●	●	20	26	170	30	6	18.3	16	S224 - 2	2503-M4x12	AAL-03-3
AIKT-HK-R/L-25-2-T6	●	○	25	32	200	40	6	23	18.5		2504-M5x16	
AIKT-HK-R/L-20-3-T6	●	○	20	27	170	30	6	18.3	16	S224 - 3	2504-M5x12	AAL-05-4
AIKT-HK-R/L-25-3-T6	●	●	25	32	200	40	6	23	18.5		2504-M5x16	
AIKT-HK-R/L-32-3-T6	●	●	32	39	250	50	6	30	22	S224 - 4	2004-M8x1x20	AAL-05-4
AIKT-HK-R/L-20-4-T6	●	○	20	27	170	30	6	18.3	16		2504-M5x12	
AIKT-HK-R/L-25-4-T6	●	○	25	32	200	40	6	23	18.5	S224 - 4	2504-M5x16	AAL-05-4
AIKT-HK-R/L-32-4-T6	●	○	32	39	250	50	6	30	22		2004-M8x1x20	
AIKT-HS223-R/L-20-2-T5	●	○	20	26	170	33	5	18.3	15	S223 - 2	2503-M4x12	AAL-03-3
AIKT-HS223-R/L-25-2-T5	●	○	25	31	200	40	5	23	17.5		2504-M5x16	
AIKT-HS223-R/L-20-3-T6	●	○	20	27	170	33	6	18.3	16	S223 - 3	2504-M5x12	AAL-05-4
AIKT-HS223-R/L-25-3-T6	●	○	25	32	200	40	6	23	18.5		2504-M5x16	

HRN Ucuna Uygun. / Compatible with HRN Insert. / Kompatibel mit HRN Wendepalten.

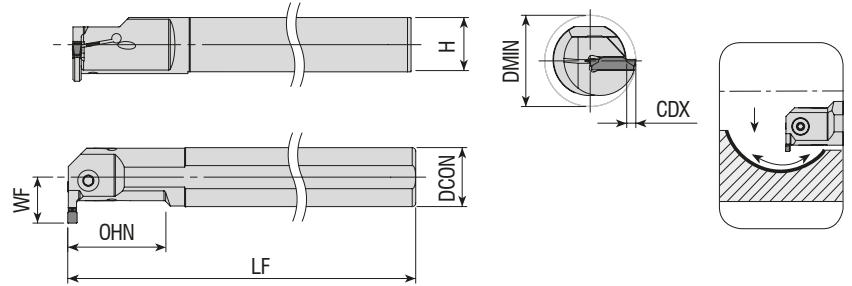

Takım Kodu Ordering Code Bestell-Bezeichnung	Stok Stock Lager		Takım Ölçüleri (mm) Dimension (mm) Abmessung (mm)							Kesici Uç Insert Wendeschneidplatte	Yedek Parçaları / Spare Parts / Ersatzteile	
	R	L	DCON	DMIN	LF	OHN	CDX	H	WF		Sıkma Vidası Screw Schraube	Anahtar Allen Key Innenschlüssel
AIKT-KM-R/L-20-2-T7	●	●	20	25	170	40	7	18.3	13	A4. - 2	2503-M4x12	AAL-03-3
AIKT-KM-R/L-20-3-T7	●	○	20	25	170	40	7	18.3	13		2504-M5x12	
AIKT-KM-R/L-25-3-T10	●	●	25	32	200	50	10	23	17	A4. - 3	2505-M6x16	AAL-07-5
AIKT-KM-R/L-32-3-T12	●	●	32	40	250	64	12	30	22		2505-M6x20	
AIKT-KM-R/L-40-3-T12	●	●	40	48	300	80	12	37.5	27	A4. - 4	2504-M5x12	AAL-05-4
AIKT-KM-R/L-20-4-T7	●	○	20	25	170	40	7	18.3	13		2504-M5x14	
AIKT-KM-R/L-32-4-T12.2-H	●	○	32	40	190	104	12.2	31	22			

R: Sağ / Right / Rechts L: Sol/Left/Links

● Stokta / In Stock / Auf Lager ○ Stokta Yok / Non Stock Item / Kein Lagerartikel, Lieferzeit auf Anfrage
KNMTL Ucuna Uygun. / Compatible with KNMTL Insert. / Kompatibel mit KNMTL Wendepalten.

Sipariş Örneği/Ordering Example/Bestellbeispiel

1 ad./pcs./stück AIKT-HK-R-20-2-T6

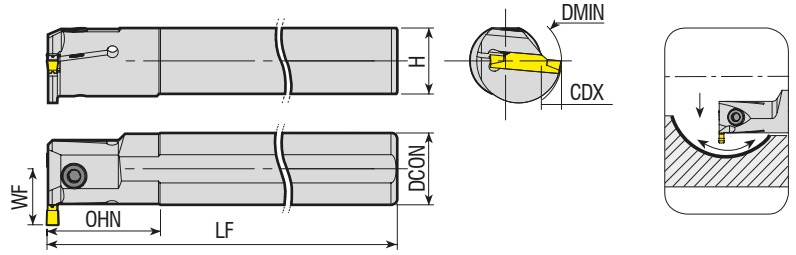

Takım Kodu Ordering Code Bestell-Bezeichnung	Stok Stock Lager		Takım Ölçüleri (mm) Dimension (mm) Abmessung (mm)							Kesici Uç Insert Wendeschneidplatte	Yedek Parçaları / Spare Parts / Ersatzteile		
	R	L	DCON	DMIN	LF	OHN	CDX	H	WF		Sıkma Vidası Screw Schraube	Anahtar Allen Key Innensechskantschlüssel	
AIKT-123-R/L-20-2-T6	●	○	20	32	170	30	6	18.3	16	123 - 2		2503-M4x12	AAL-03-3
AIKT-123-R/L-25-2-T6	●	○	25	32	200	40	6	18.3	18.5			2504-M5x12	
AIKT-123-R/L-32-2-T7	●	○	32	41	250	45	7	30	23			2004-M8x1x20	
AIKT-123-R/L-20-3-T6	●	○	20	32	170	30	6	18.3	16	123 - 3		2504-M5x16	AAL-05-4
AIKT-123-R/L-25-3-T7	●	○	25	32	200	40	7	23	19.5			2004-M8x1x20	
AIKT-123-R/L-32-3-T9	●	○	32	41	250	50	9	30	25			2504-M5x16	
AIKT-123-R/L-20-4-T8	●	○	20	29	170	30	8	18.3	18	123 - 4		2504-M5x16	AAL-05-4
AIKT-123-R/L-25-4-T7	●	○	25	32	200	40	7	23	19.5			2004-M8x1x20	
AIKT-123-R/L-32-4-T7	●	●	32	41	250	45	7	30	23			2504-M5x16	
AIKT-123-R/L-32-4-T10	●	○	32	43	250	50	10	30	26	123 - 5		2504-M5x16	AAL-05-4
AIKT-123-R/L-25-5-T8	●	○	25	34	200	40	8	23	20.5			2004-M8x1x20	
AIKT-123-R/L-32-5-T11	●	●	32	43	250	50	11	30	27			2504-M5x16	

SNDVK Ucuna Uygundur. / Compatible with SNDVK Insert. / Kompatibel mit SNDVK Wendeplatten.

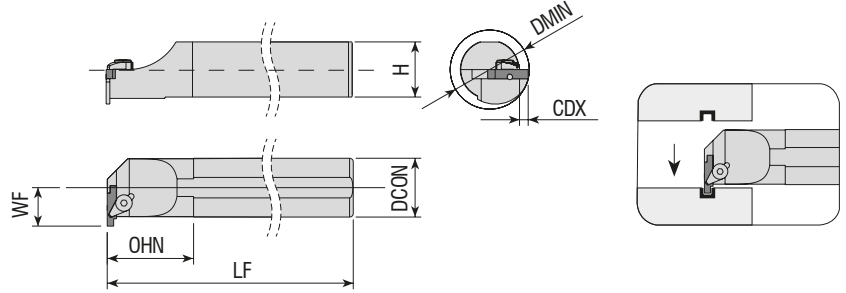

Takım Kodu Ordering Code Bestell-Bezeichnung	Stok Stock Lager		Takım Ölçüleri (mm) Dimension (mm) Abmessung (mm)							Kesici Uç Insert Wendeschneidplatte	Yedek Parçaları / Spare Parts / Ersatzteile					
	R	L	DCON	DMIN	LF	OHN	CDX	H	WF		Baskı Parçası Wedge Clamp Spannpratze	Sıkma Vidası Screw Schraube	Pim Pin Stift	Anahtar Allen Key Innensechskantschlüssel		
AIKT-154.91-R/L-16-3-T3	●	●	16	20	150	35	3	14.8	11	154.91 - 3			AKV-10-M6x14	APM-06	AAL-05-4	
AIKT-154.91-R/L-20-3-T4	●	●	20	25	170	38	4	18.3	14							ACK-06
AIKT-154.91-R/L-25-3-T4	●	●	25	31	200	40	4	23	16.5							ACK-03
AIKT-154.91-R/L-25-5-T5	●	●	25	31	200	45	5	23	17.5	154.91 - 5			AKV-21-M6x18	APM-06	AAL-03-3	
AIKT-154.91-R/L-32-5-T5	●	●	32	38	250	50	5	30	21							ACK-03

R: Sağ / Right / Rechts L: Sol/Left/Links

● Stokta / In Stock / Auf Lager ○ Stokta Yok / Non Stock Item / Kein Lagerartikel, Lieferzeit auf Anfrage
SNDVK Ucuna Uygundur. / Compatible with SNDVK Insert. / Kompatibel mit SNDVK Wendeplatten.

Sipariş Örneği/Ordering Example/Bestellbeispiel
1 ad./pcs./stück AIKT-123-R-20-2-T6

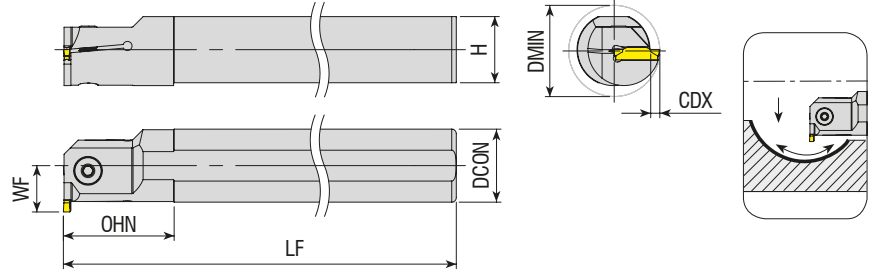

Takım Kodu Ordering Code Bestell-Bezeichnung	Stok Stock Lager		Takım Ölçüleri (mm) Dimension (mm) Abmessung (mm)							Kesici Uç Insert Wendeschneidplatte	Yedek Parçaları / Spare Parts / Ersatzteile	
	R	L	DCON	DMIN	LF	OHN	CDX	H	WF		Sıkma Vidası Screw Schraube	Anahtar Allen Key Innensechskantschlüssel
AIKT-ZCC2-R/L-16-2-T4	●	○	16	21	150	28	4	14.8	12	Z.BD - 2	2503-M4x10	AAL-03-3
AIKT-ZCC2-R/L-20-3-T5	●	●	20	27	170	30	5	18.3	15		Z.FD - 3	
AIKT-ZCC2-R/L-20-3-T8	●	○	20	29	170	30	8	18.3	18	2504-M5x16		
AIKT-ZCC2-R/L-25-3-T5	●	○	25	31	200	40	5	23	17.5	2004-M8x1x20		
AIKT-ZCC2-R/L-25-3-T10	●	○	25	36	200	40	10	23	22.5			
AIKT-ZCC2-R/L-32-3-T6	●	○	32	39	250	50	6	30	22	2504-M5x12		
AIKT-ZCC2-R/L-32-3-T8	●	○	32	41	250	50	8	30	24			
AIKT-ZCC2-R/L-32-3-T13	●	○	32	46	250	50	13	30	29	2504-M5x16		
AIKT-ZCC2-R/L-40-3-T12	●	○	40	53	300	55	12	37.5	32			
AIKT-ZCC2-R/L-25-4-T6	●	○	25	32	200	40	6	23	18.5	Z.GD - 4	2004-M8x1x20	
AIKT-ZCC2-R/L-32-4-T7	●	○	32	40	250	50	7	30	23			
AIKT-ZCC2-R/L-32-4-T8	●	○	32	41	250	50	8	30	24	Z.HD - 5		
AIKT-ZCC2-R/L-32-4-T10	●	○	32	43	250	50	10	30	26			
AIKT-ZCC2-R/L-32-5-T7	●	○	32	40	250	50	7	30	23	2004-M8x1x20		
AIKT-ZCC2-R/L-32-5-T8	●	○	32	41	250	50	8	30	24			
AIKT-ZCC2-R/L-40-5-T8	●	○	40	49	300	55	8	37.5	28			
AIKT-ZCC2-R/L-40-5-T10	●	○	40	51	300	55	10	37.5	30			

ZCC Ucuna Uygundur. / Compatible with ZCC Insert. / Kompatibel mit ZCC Wendeplatten.

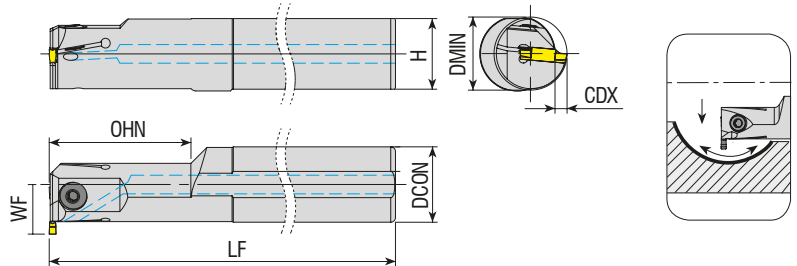

Takım Kodu Ordering Code Bestell-Bezeichnung	Stok Stock Lager		Takım Ölçüleri (mm) Dimension (mm) Abmessung (mm)							Kesici Uç Insert Wendeschneidplatte	Yedek Parçaları / Spare Parts / Ersatzteile	
	R	L	DCON	DMIN	LF	OHN	CDX	H	WF		Sıkma Vidası Screw Schraube	Anahtar Allen Key Innensechskantschlüssel
AIKT-TD-R-16-2-T8.5-H	●	○	16	25	150	28	8.5	14.8	16.5	TD-2	2503-M4x10	AAL-03-3
AIKT-TD-R-20-3-T6-H	●	○	20	25	170	40	6	18.3	16		TD-3	
AIKT-TD-R-25-3-T6-H	●	○	25	25	200	40	6	23	18.5			
AIKT-TD-R-32-3-T5-H	●	○	32	31	250	60	5	30	21	2004-M8x1x20		

R: Sağ / Right / Rechts L: Sol/Left/Links

● Stokta / In Stock / Auf Lager ○ Stokta Yok / Non Stock Item / Kein Lagerartikel, Lieferzeit auf Anfrage
TGTC Ucuna Uygundur. / Compatible with TGTC Insert. / Kompatibel mit TGTC Wendeplatten.

Sipariş Örneği/Ordering Example/Bestellbeispiel
1 ad./pcs./stück AIKT-ZCC-R-20-3-T5

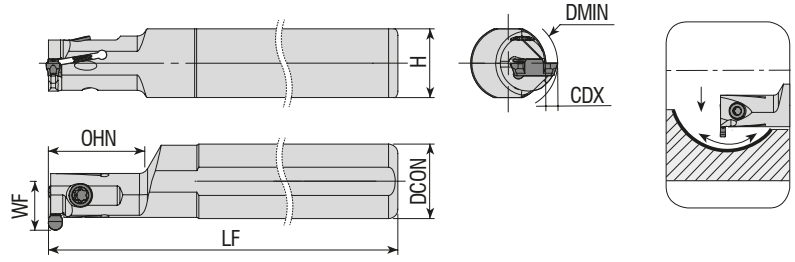

Takım Kodu Ordering Code Bestell-Bezeichnung	Stok Stock Lager		Takım Ölçüleri (mm) Dimension (mm) Abmessung (mm)							Kesici Uç Insert Wendeschneidplatte	Yedek Parçaları / Spare Parts / Ersatzteile	
	R	L	DCON	DMIN	LF	OHN	CDX	H	WF		Sıkma Vidası Screw Schraube	Anahtar Allen Key Inmenschlüssel
AIKT-IGE-R/L-10-2-T3-H	●	○	10	11.5	125	25	3	9	8.3	GEPI - 2	3008-M3x8	80-T08
AIKT-IGE-R/L-16-2-T3-D11.5	●	○	16	11.5	125	20	3	14.8	11.1			
AIKT-IGE-R/L-16-2-T2.5-H	●	●	16	13	125	20	2.5	14.8	10.5	GEPI - 3	1315-M4x11	80-T15
AIKT-IGE-R/L-16-3-T2.5-H	●	○	16	13	125	20	2.5	14.8	10.5			
AIKT-IGE-R/L-16-3-T2.5-D20	●	○	16	20	125	28	2.5	14.8	10.5			

ISCR Ucuna Uygun. / Compatiple with ISCR Insert. / Kompatibel mit ISCR Wendeplatten.

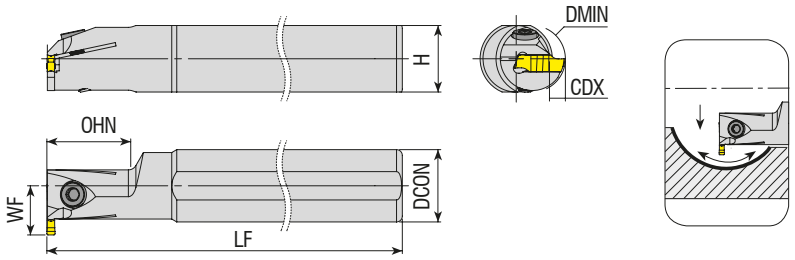

Takım Kodu Ordering Code Bestell-Bezeichnung	Stok Stock Lager		Takım Ölçüleri (mm) Dimension (mm) Abmessung (mm)							Kesici Uç Insert Wendeschneidplatte	Yedek Parçaları / Spare Parts / Ersatzteile	
	R	L	DCON	DMIN	LF	OHN	CDX	H	WF		Sıkma Vidası Screw Schraube	Anahtar Allen Key Inmenschlüssel
AIKT-IGI-R/L-20-3-T4	●	●	20	20	170	25	4	18.3	14.5	GIMIY / GIPI - 3	1020-M5x14	80-T20
AIKT-IGI-R/L-25-3-T5	●	●	25	23	200	30	5	23	17		2504-M5x16	
AIKT-IGI-R/L-32-3-T5	●	●	32	31	250	30	5	30	21		2004-M8x1x20	AAL-05-4
AIKT-IGI-R/L-40-3-T5	●	○	40	50	300	50	5	37.5	25	GIMIY / GIPI - 4	1020-M5x14	80-T20
AIKT-IGI-R/L-20-4-T4	●	●	20	20	170	25	4	18.3	14.5		GIMIY / GIPI - 5	2504-M5x16
AIKT-IGI-R/L-25-5-T10	●	○	25	32	200	25	10	23	22.5	GIMIY / GIPI - 5		2504-M5x16
AIKT-IGI-R/L-25-5-T15	●	○	25	37	200	25	15	23	27.5			

R: Sağ / Right / Rechts L: Sol/Left/Links

● Stokta / In Stock / Auf Lager ○ Stokta Yok / Non Stock Item / Kein Lagerartikel, Lieferzeit auf Anfrage
ISCR Ucuna Uygun. / Compatiple with ISCR Insert. / Kompatibel mit ISCR Wendeplatten.

Sipariş Örneği/Ordering Example/Bestellbeispiel
1 ad./pcs./stück AIKT-IGE-R-10-2-T3-H

Note: "OHN" boyunu D min çapa göre verilmiştir.

Note: Lengths of "OHN" are given according to D min diameter.
Hinweis: Maß "OHN" soll identisch mit Dmin sein

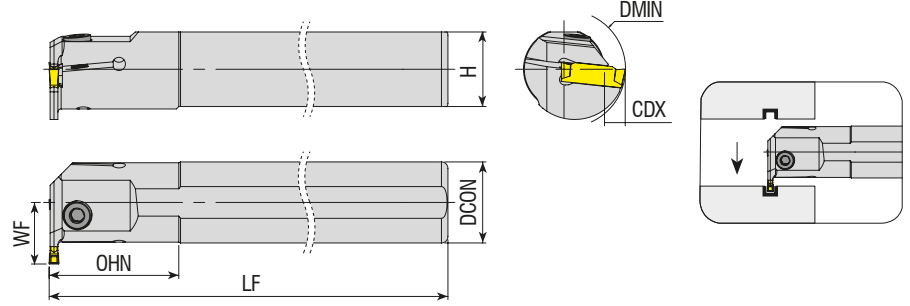

Takım Kodu Ordering Code Bestell-Bezeichnung	Stok Stock Lager		Takım Ölçüleri (mm) Dimension (mm) Abmessung (mm)							Kesici Uç Insert Wendeschneidplatte	Yedek Parçaları / Spare Parts / Ersatzteile	
	R	L	DCON	DMIN	LF	OHN	CDX	H	WF		Sıkma Vidası Screw Schraube	Anahtar Allen Key Innerschlüssel
AIKT-I-R/L-20-3-T5	●	●	20	26	170	25	5	18.3	15.5	DGN - 3	2504-M5x12	AAL-05-4
AIKT-I-R/L-25-3-T6	●	●	25	32	200	40	6	23	19		2504-M5x16	

ISCR Ucuna Uygunur. / Compatible with ISCR Insert. / Kompatibel mit ISCR Wendeplatten.

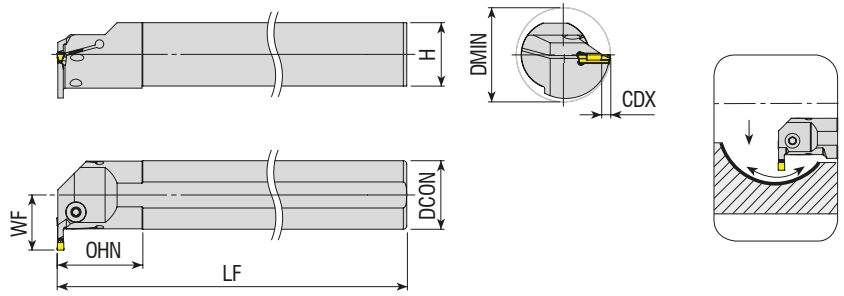

Takım Kodu Ordering Code Bestell-Bezeichnung	Stok Stock Lager		Takım Ölçüleri (mm) Dimension (mm) Abmessung (mm)							Kesici Uç Insert Wendeschneidplatte	Yedek Parçaları / Spare Parts / Ersatzteile	
	R	L	DCON	DMIN	LF	OHN	CDX	H	WF		Sıkma Vidası Screw Schraube	Anahtar Allen Key Innerschlüssel
AIKT-IG-R/L-25-4-T10-H	●	●	25	36	200	40	10	23	22.7	DGN / GRP - 4	2504-M5X16	AAL-05-4
AIKT-IG-R/L-32-4-T10-H	●	●	32	43	250	45	10	30	26.2		2004-M8x1x20	
AIKT-IG-R/L-40-4-T12-H	●	●	40	53	300	50	12	37.5	32.2	DGN / GRP - 5	2504-M5X16	AAL-05-4
AIKT-IG-R/L-25-5-T10-H	●	○	25	36	200	40	10	23	22.7		2004-M8x1x20	
AIKT-IG-R/L-32-5-T10-H	●	○	32	43	250	45	10	30	26.2			
AIKT-IG-R/L-40-5-T12-H	●	○	40	53	250	50	12	37.5	32.2			
AIKT-IG-R/L-50-5-T12-H	●	○	50	63	300	60	12	47	37.2			

R: Sağ / Right / Rechts L: Sol/Left/Links
● Stokta / In Stock / Auf Lager ○ Stokta Yok / Non Stock Item / Kein Lagerartikel, Lieferzeit auf Anfrage
ISCR Ucuna Uygunur. / Compatible with ISCR Insert. / Kompatibel mit ISCR Wendeplatten.

Sipariş Örneği/Ordering Example/Bestellbeispiel
1 ad./pcs./stück AIKT-I-R-20-3-T5

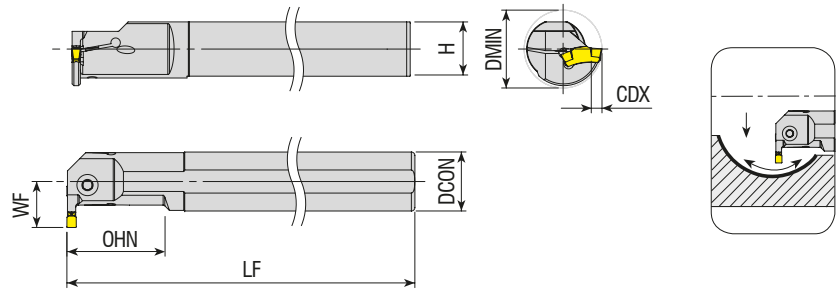

Takım Kodu Ordering Code Bestell-Bezeichnung	Stok Stock Lager		Takım Ölçüleri (mm) Dimension (mm) Abmessung (mm)							Kesici Uç Insert Wendeschneidplatte	Yedek Parçaları / Spare Parts / Ersatzteile	
	R	L	DCON	DMIN	LF	OHN	CDX	H	WF		Sıkma Vidası Screw Schraube	Anahtar Allen Key Innenschlüssel
AIKT-ITG-R/L-16-3-T6-H	●	●	16	20	150	25	6	14.8	12	TGM. - 3	1020-M4.5X14	80-T20
AIKT-ITG-R/L-20-3-T6-H	●	●	20	25	170	32	6	18.3	14.2		1020-M4.5X16	
AIKT-ITG-R/L-25-3-T8-H	●	●	25	32	200	40	8	23	18.8		2504-M5X16	AAL-05-4
AIKT-ITG-R/L-32-3-T8-H	●	●	32	38	250	49	8	30	22		2004-M8x1x20	
AIKT-ITG-R/L-20-4-T6-H	●	●	20	25	170	33	6	18.3	14.2	TGM. - 4	1020-M4.5X16	80-T20
AIKT-ITG-R/L-25-4-T7-H	●	●	25	31	200	41	7	23	17.5		2504-M5X16	
AIKT-ITG-R/L-25-4-T9-H	●	●	25	32.5	200	41	9	23	19.5		2004-M8x1x20	AAL-05-4
AIKT-ITG-R/L-32-4-T11-H	●	●	32	42	250	50	11	30	25.5			
AIKT-ITG-R/L-40-4-T11-H	●	●	40	53	300	50	11	37.5	32	TGM. - 6.35	2004-M8x1x20	
AIKT-ITG-R/L-32-6.35-T17.5-H	●	●	32	57	250	50	17.5	30	29			

ISCR Ucuna Uygun. / Compatible with ISCR Insert. / Kompatibel mit ISCR Wendeplatten.

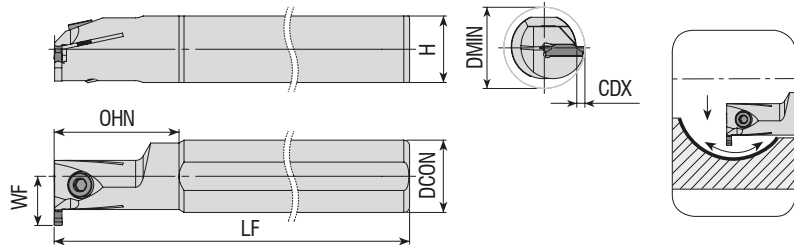

Takım Kodu Ordering Code Bestell-Bezeichnung	Stok Stock Lager		Takım Ölçüleri (mm) Dimension (mm) Abmessung (mm)							Kesici Uç Insert Wendeschneidplatte	Yedek Parçaları / Spare Parts / Ersatzteile	
	R	L	DCON	DMIN	LF	OHN	CDX	H	WF		Sıkma Vidası Screw Schraube	Anahtar Allen Key Innenschlüssel
AIKT-GP-R/L-20-2-T4	●	○	20	25	170	30	4	18.3	14.5	GP - 2	2503-M4x12	AAL-03-3
AIKT-GP-R/L-25-2-T6	●	○	25	32	200	40	6	23	18.5			
AIKT-GP-R/L-20-3-T6	●	○	20	27	170	30	6	18.3	16	GP - 3	2504-M5x16	AAL-05-4
AIKT-GP-R/L-25-3-T6	●	○	25	32	200	40	6	23	18.5			
AIKT-GP-R/L-32-3-T6	●	○	32	39	250	50	6	30	22	2004-M8x1x20		
AIKT-GP-R/L-20-4-T6	●	○	20	27	170	30	6	18.3	16	GP - 4	2504-M5x16	
AIKT-GP-R/L-25-4-T6	●	○	25	32	200	40	6	23	18.5		2004-M8x1x20	
AIKT-GP-R/L-32-4-T6	●	○	32	39	250	50	6	30	22			

R: Sağ / Right / Rechts L: Sol/Left/Links

● Stokta / In Stock / Auf Lager ○ Stokta Yok / Non Stock Item / Kein Lagerartikel, Lieferzeit auf Anfrage
PLBT Ucuna Uygun. / Compatible with PLBT Insert. / Kompatibel mit PLBT Wendeplatten.

Sipariş Örneği/Ordering Example/Bestellbeispiel
1 ad./pcs./stück AIKT-ITG-R-16-3-T6-H

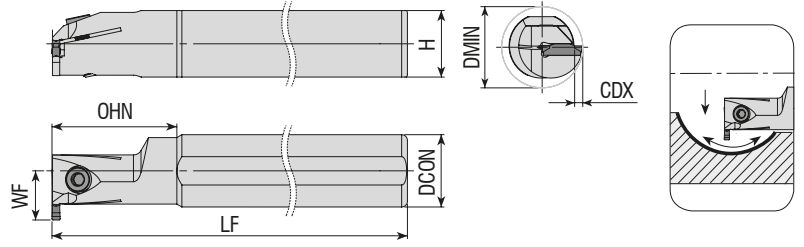

Takım Kodu Ordering Code Bestell-Bezeichnung	Stok Stock Lager		Takım Ölçüleri (mm) Dimension (mm) Abmessung (mm)							Kesici Uç Insert Wendeschneidplatte	Yedek Parçaları / Spare Parts / Ersatzteile	
	R	L	DCON	DMIN	LF	OHN	CDX	H	WF		Sıkma Vidası Screw Schraube	Anahtar Allen Key Innensechskantschlüssel
AIKT-SGC-R/L-25-3-T6	●	○	25	32	200	40	6	23	18.5	GCM N30	2504-M5x16	AAL-05-4
AIKT-SGC-R/L-32-3-T6	●	○	32	39	250	50	6	30	22		2004-M8x1x20	
AIKT-SGC-R/L-40-3-T6	●	○	40	47	300	55	6	37.5	26			

SMTM Ucuna Uygunur. / Compatible with SMTM Insert. / Kompatibel mit SMTM Wendeplatten.

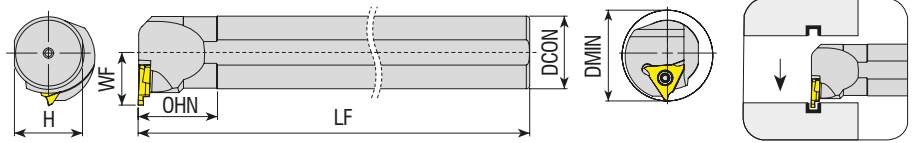

Takım Kodu Ordering Code Bestell-Bezeichnung	Stok Stock Lager		Takım Ölçüleri (mm) Dimension (mm) Abmessung (mm)							Kesici Uç Insert Wendeschneidplatte	Yedek Parçaları / Spare Parts / Ersatzteile	
	R	L	DCON	DMIN	LF	OHN	CDX	H	WF		Sıkma Vidası Screw Schraube	Anahtar Allen Key Innensechskantschlüssel
AIKT-QC11-R/L-20-(0.5-1.8)	●	○	20	16	150	40	-	18.3	12	QC11R/L (0.50-1.80)	3008 M2.5x6	80-T08
AIKT-QC16-R/L-20-(0.5-1.8)	○	○	20	25	150	35	-	18.3	13.5	QC16R/L (0.50-1.80)	4015-M3.5x10	80-T15
AIKT-QC16-R/L-20-(0.5-2.5)	●	○	20	25	150	35	-	18.3	13.5	QC16R/L (0.50-2.50)		
AIKT-QC22-R/L-25-(1-2.3)	○	○	25	35	150	35	-	23	18.2	QC22R/L (1.00-2.30)	1120 M5x20	80-T20
AIKT-QC22-R/L-25-(2.5-3.3)	●	○	25	35	150	35	-	23	18.2	QC22R/L (2.50-3.30)		
AIKT-QC22-R/L-25-(3.3-4.8)	●	○	25	35	150	35	-	23	18.2	QC22R/L (3.30-4.80)		
AIKT-QC22-R/L-32-(1-2.3)	○	○	32	45	150	35	-	30	23.2	QC22R/L (1.00-2.30)		

R: Sağ / Right / Rechts L: Sol/Left/Links

● Stokta / In Stock / Auf Lager ○ Stokta Yok / Non Stock Item / Kein Lagerartikel, Lieferzeit auf Anfrage
ZCC Ucuna Uygunur. / Compatible with ZCC Insert. / Kompatibel mit ZCC Wendeplatten.

Sipariş Örneği/Ordering Example/Bestellbeispiel
1 ad./pcs./stück AIKT-SGC-R-25-3-T6

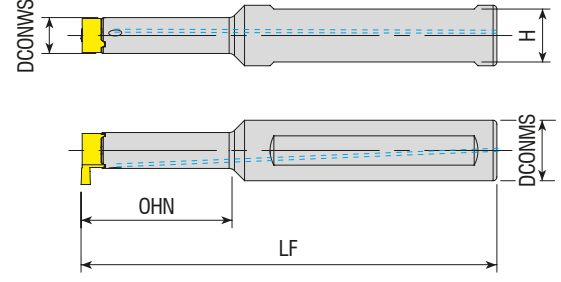

Takım Kodu Ordering Code Bestell-Bezeichnung	Stok Stock Lager	Takım Ölçüleri (mm) Dimension (mm) Abmessung (mm)					Kesici Uç Insert Wendeschneidplatte	Yedek Parçaları / Spare Parts / Ersatzteile	
		DCONMS	DCONWS	LF	OHN	H		Sıkma Vidası Screw Schraube	Anahtar Allen Key Innerschraubschlüssel
AIKT-MB07-A16-090-15	●	16	7.4	90	15	14	MB - 07	4008-M3x8	80-T08
AIKT-MB07-A16-090-22	●	16	7.4	90	22	14			
AIKT-MB09-A16-090-19	●	16	9.5	90	19	14	MB - 09	4015-M4x11	80-T15
AIKT-MB09-A16-095-28	●	16	9.5	95	28	14			
AIKT-MB09-A16-110-40	●	16	9.5	110	40	14			

R: Sağ / Right / Rechts L: Sol/Left/Links
● Stokta / In Stock / Auf Lager ○ Stokta Yok / Non Stock Item / Kein Lagerartikel, Lieferzeit auf Anfrage
SNDVK Ucuna Uygundur. / Compatible with SNDVK Insert. / Kompatibel mit SNDVK Wendepfatten.

Sipariş Örneği/Ordering Example/Bestellbeispiel
1 ad./pcs./stück AIKT-MB07-A16-090-15

