



*konusulan*  
**the spoken** kalite...  
*quality...*

# KANAL AÇMA

KANAL AÇMA TAKIMLARI  
GROOVING TOOLHOLDERS  
STECHHALTER



AKKO **A** **AKT** - **K** - **R** - **2525**

**100 - 150** - **4** - **T22**

**2** Kesici Stili / Cutter Style / Cutter-Stil

DKT: Dış Çap Kanal Açma Takımı / External Grooving Toolholders  
Außen-Steckhalter  
IKT: Delik İçi Kanal Açma Takımı / Internal Grooving Toolholders  
Innen-Steckhalter  
AKT: Dış Çap Alın Kanal Takımları / Face Grooving Toolholders  
Axial-Steckhalter  
LKT: L Tip Alın Kanal Açma Takımı / L Type Face Grooving Toolholders  
Axial-Steckhalter L-Type

**3** Uç Tipi / Insert Type / Plattenform

KRLY / MGM.  
HRN / S312, S229, S224, S223  
ISCR / DGN, GI, GTN  
SNDVK / 123, 151, 154.91  
ZCC  
KM / A4.  
ARN / LOMR.

TGTC / TD.

**4** Kesme Yönü / Cutting Direction  
Halteausführung

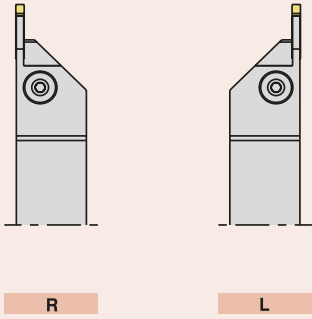

**5** Kesme Kenar Yüksekliği ve Şaft Genişliği  
Cutting Edge Height and Shank Width  
Schafthöhe und Schafbreite

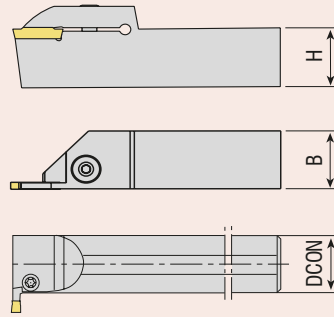

**6** Kesme Aralığı  
Cutting Diameter  
Durchmesser für Axialeinstechen

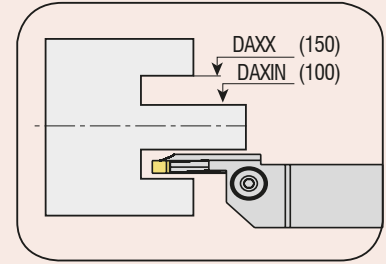

**7** Kesme Kenar Genişliği / Cutting Width Edge  
Plattenbreite

ÖR/E.G :  
2 = 2.0 mm  
3 = 3.0 mm  
4 = 4.0 mm  
5 = 5.0 mm  
6 = 6.0 mm  
8 = 8.0 mm

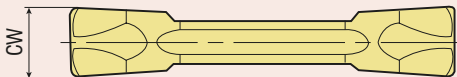

**8** Kesme Derinliği / Cutting Depth / Maximale Schnitttiefe

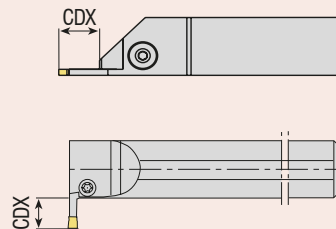

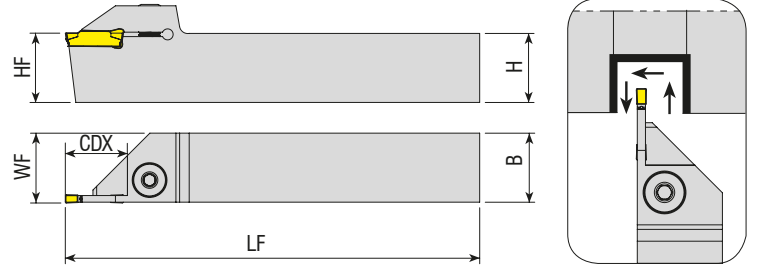

Takım Kodu Ordering Code Bestell-Bezeichnung	Stok Stock Lager		Takım Ölçüleri (mm) Dimension (mm) Abmessung (mm)				Kesici Uç Insert Wendeschneidplatte	Yedek Parçaları / Spare Parts / Ersatzteile			
	R	L	HF=H	B	LF	WF		CDX	Sıkma Vidası Screw Schraube	Pul Stamp Ring	Anahtar Allen Key Inmenschenschlüssel
ADKT-K-R/L-1212-1.5-T15	●	●	12	12	100	12.2	15	MGM. - 1.5	AKV-02-M6x22	ABPL-01	AAL-03-3
ADKT-K-R/L-2020-1.5-T15	●	●	20	20	125	20.2	15				
ADKT-K-R/L-1212-2-T15	●	●	12	12	100	16.3	15				
ADKT-K-R/L-1616-2-T15	●	●	16	16	125	16.3	15	MGM. - 2	AKV-02-M6x22	ABPL-01	AAL-03-3
ADKT-K-R/L-2020-2-T15	●	●	20	20	125	20.3	15				
ADKT-K-R/L-2525-2-T15	●	●	25	25	150	25.3	15				
ADKT-K-R/L-3232-2-T15	●	●	32	32	170	32.3	15	MGM. - 3	AKV-02-M6x22	ABPL-01	AAL-03-3
ADKT-K-R/L-1212-3-T15	●	●	12	12	100	16.3	15				
ADKT-K-R/L-1616-3-T15	●	●	16	16	125	16.4	15				
ADKT-K-R/L-2020-3-T20	●	●	20	20	125	20.4	20	MGM. - 3	AKV-02-M6x22	ABPL-01	AAL-03-3
ADKT-K-R/L-2020-3-R28	●	●	20	20	125	20.3	28				
ADKT-K-R/L-2525-3-R15	●	●	25	25	150	25.4	15				
ADKT-K-R/L-2525-3-T22	●	●	25	25	150	25.4	22	MGM. - 3	AKV-02-M6x22	ABPL-01	AAL-03-3
ADKT-K-R/L-3232-3-T22	●	●	32	32	170	32.4	22				
ADKT-K-R/L-2020-4-T20	●	●	20	20	125	20.4	20				
ADKT-K-R/L-2020-4-R25	●	○	20	20	125	20.4	25	MGM. - 4	AKV-02-M6x22	ABPL-01	AAL-03-3
ADKT-K-R/L-2525-4-T18	●	●	25	25	150	25.4	18				
ADKT-K-R/L-2525-4-T22	●	●	25	25	150	25.4	22				
ADKT-K-R/L-3232-4-T22	●	●	32	32	170	32.4	22	MGM. - 4	AKV-02-M6x22	ABPL-01	AAL-03-3
ADKT-K-R/L-2020-5-T20	●	●	20	20	125	20.5	20				
ADKT-K-R/L-2525-5-T18	●	●	25	25	150	25.5	18				
ADKT-K-R/L-2525-5-T25	●	●	25	25	150	25.5	25	MGM. - 5	AKV-02-M6x22	ABPL-01	AAL-03-3
ADKT-K-R/L-3232-5-T25	●	●	32	32	170	32.5	25				
ADKT-K-R/L-2525-6-T25	●	●	25	25	150	25.6	25				
ADKT-K-R/L-3232-6-T25	●	●	32	32	170	32.6	25	MGM. - 6	AKV-02-M6x22	ABPL-01	AAL-03-3
ADKT-K-R/L-3232-8-T32	●	●	32	32	170	32.8	32				

R: Sağ / Right / Rechts L: Sol/Left/Links

● Stokta / In Stock / Auf Lager ○ Stokta Yok / Non Stock Item / Kein Lagerartikel, Lieferzeit auf Anfrage

KRLY - JD Ucuna Uygunudur. / Compatible with KRLY - JD Insert. / Kompatibel mit KRLY - JD Wendeplatten

Sipariş Örneği/Ordering Example/Bestellbeispiel

1 ad./pcs./stück ADKT-K-R-1212-2-T15

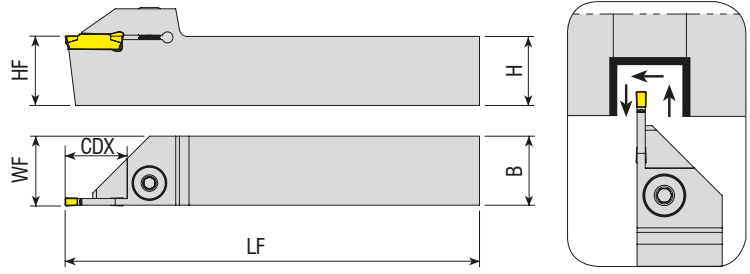

Takım Kodu Ordering Code Bestell-Bezeichnung	Stok Stock Lager		Takım Ölçüleri (mm) Dimension (mm) Abmessung (mm)					Kesici Uç Insert Wendeschneidplatte	Yedek Parçaları / Spare Parts / Ersatzteile		
	R	L	HF=H	B	LF	WF	CDX		Sıkma Vidası Screw Schraube	Pul Stamp Ring	Anahtar Allen Key Innerschlüsselschlüssel
ADKT-KG-R/L-2020-2-T15	●	●	20	20	125	20.2	15	KG.. - 2	AKV-02-M6x22	ABPL-01	AAL-03-3
ADKT-KG-R/L-2525-2-T15	●	○	25	25	150	25.2	15				
ADKT-KG-R/L-2525-2-T17	●	○	25	25	150	25.2	17	KG.. - 3	2004-M8x1x20	-	AAL-05-4
ADKT-KG-R/L-1616-3-T20	●	●	16	16	125	16.3	20				
ADKT-KG-R/L-2020-3-T20	●	●	20	20	125	20.3	20	KG.. - 4	2004-M8x1x20	-	AAL-05-4
ADKT-KG-R/L-2525-3-T22	●	●	25	25	150	25.3	22				
ADKT-KG-R/L-2020-4-T20	●	●	20	20	125	20.4	20	KG.. - 5	2004-M8x1x20	-	AAL-05-4
ADKT-KG-R/L-2525-4-T16	●	○	25	25	150	25.4	16				
ADKT-KG-R/L-2525-4-T22	●	○	25	25	150	25.4	22	KG.. - 6	2004-M8x1x20	-	AAL-05-4
ADKT-KG-R/L-2525-5-T25	●	○	25	25	150	25.5	25				
ADKT-KG-R/L-2525-6-T25	○	○	25	25	150	25.6	25				

KRLY Ucuna Uygun. / Compatible with KRLY Insert. / Kompatibel mit KRLY Wendeplatten

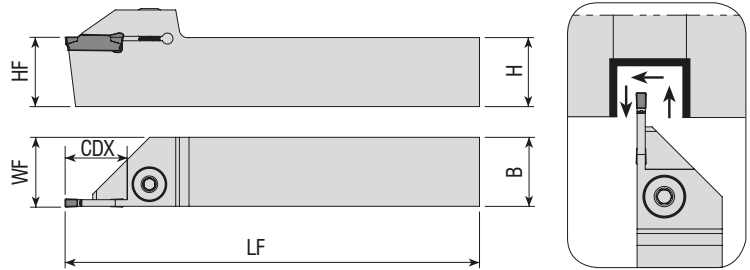

Takım Kodu Ordering Code Bestell-Bezeichnung	Stok Stock Lager		Takım Ölçüleri (mm) Dimension (mm) Abmessung (mm)					Kesici Uç Insert Wendeschneidplatte	Yedek Parçaları / Spare Parts / Ersatzteile		
	R	L	HF=H	B	LF	WF	CDX		Sıkma Vidası Screw Schraube	Pul Stamp Ring	Anahtar Allen Key Innerschlüsselschlüssel
ADKT-SGC-R/L-1212-2-R15	●	●	12	12	100	16.2	15	GCM N20	AKV-02-M6x22	ABPL-01	AAL-03-3
ADKT-SGC-R/L-1616-2-R15	●	●	16	16	125	16.2	15				
ADKT-SGC-R/L-2020-2-R20	●	●	20	20	125	20.2	20	GCM N30	2004-M8x1x20	-	AAL-05-4
ADKT-SGC-R/L-2525-2-R20	●	●	25	25	150	25.2	20				
ADKT-SGC-R/L-1212-3-R15	●	●	12	12	100	16.3	15	GCM N40	2004-M8x1x20	-	AAL-05-4
ADKT-SGC-R/L-1616-3-R15	●	●	16	16	125	16.3	15				
ADKT-SGC-R/L-2020-3-R22	●	●	20	20	125	20.3	22	GCM N40	2004-M8x1x20	-	AAL-05-4
ADKT-SGC-R/L-2525-3-R15	●	○	25	25	150	25.3	15				
ADKT-SGC-R/L-2525-3-R22	●	●	25	25	150	25.3	22	GCM N40	2004-M8x1x20	-	AAL-05-4
ADKT-SGC-R/L-2525-4-R25	●	○	25	25	150	25.4	25				

R: Sağ / Right / Rechts L: Sol/Left/Links

● Stokta / In Stock / Auf Lager ○ Stokta Yok / Non Stock Item / Kein Lagerartikel, Lieferzeit auf Anfrage

SMTM Ucuna Uygun. / Compatible with SMTM Insert. / Kompatibel mit SMTM Wendeplatten

Sipariş Örneği/Ordering Example/Bestellbeispiel

1 ad./pcs./stück ADKT-KG-R-2020-2-T15

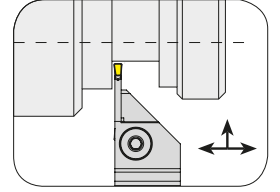
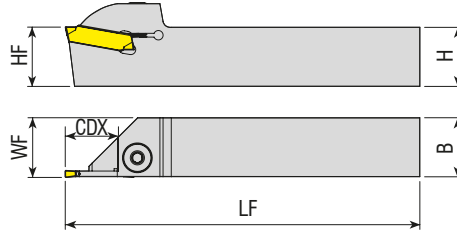

Takım Kodu Ordering Code Bestell-Bezeichnung	Stok Stock Lager		Takım Ölçüleri (mm) Dimension (mm) Abmessung (mm)				Kesici Uç Insert Wendeschneidplatte	Yedek Parçaları / Spare Parts / Ersatzteile			
	R	L	HF=H	B	LF	WF		CDX	Sıkma Vidası Screw Schraube	Pul Stamp Ring	Anahtar Allen Key Innerschloßschlüssel
ADKT-H-R/L-2020-3-T20	●	●	20	20	125	20.5	20	S229 - 3	2004-M8x1x20	-	AAL-05-4
ADKT-H-R/L-2525-3-T22	●	●	25	25	150	25.5	22				
ADKT-H-R/L-2525-3-T26	●	●	25	25	150	25.5	26				
ADKT-H-R/L-2020-4-T20	●	●	20	20	125	20.5	20	S229 - 4	2004-M8x1x20	-	AAL-05-4
ADKT-H-R/L-2525-4-T22	●	●	25	25	150	25.5	22				
ADKT-H-R/L-3232-4-T22	●	●	32	32	170	32.5	22				
ADKT-H-R/L-2020-5-T20	●	●	20	20	125	20.5	20	S229 - 5	2004-M8x1x20	-	AAL-05-4
ADKT-H-R/L-2525-5-T25	●	●	25	25	150	25.5	25				
ADKT-H-R/L-2525-6-T25	●	●	25	25	150	25.6	25				

HRN Ucuna Uygun. / Compatible with HRN Insert. / Kompatibel mit HRN Wendeplatten.

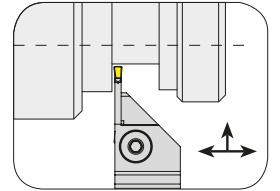
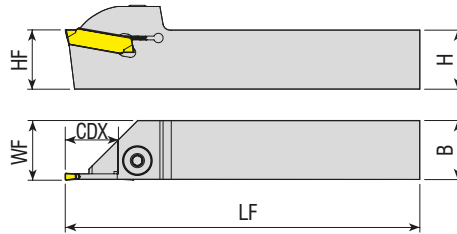

Takım Kodu Ordering Code Bestell-Bezeichnung	Stok Stock Lager		Takım Ölçüleri (mm) Dimension (mm) Abmessung (mm)				Kesici Uç Insert Wendeschneidplatte	Yedek Parçaları / Spare Parts / Ersatzteile			
	R	L	HF=H	B	LF	WF		CDX	Sıkma Vidası Screw Schraube	Pul Stamp Ring	Anahtar Allen Key Innerschloßschlüssel
ADKT-HK-R/L-1616-2-T15	●	●	16	16	125	16.3	15	S224 - 2	AKV-02-M6x22	ABPL-01	AAL-03-3
ADKT-HK-R/L-2020-2-T15	●	●	20	20	125	20.3	15				
ADKT-HK-R/L-2525-2-T15	●	●	25	25	150	25.3	15				
ADKT-HK-R/L-1616-3-T15	○	○	16	16	125	16.3	15	S224 - 3	2004-M8x1x20	-	AAL-05-4
ADKT-HK-R/L-2020-3-T20	●	●	20	20	125	20.4	20				
ADKT-HK-R/L-2525-3-T22	●	●	25	25	150	25.4	22				
ADKT-HK-R/L-2020-4-T20	●	●	20	20	125	20.4	20	S224 - 4	2004-M8x1x20	-	AAL-05-4
ADKT-HK-R/L-2525-4-T22	●	●	25	25	150	25.4	22				
ADKT-HS223-R/L-2020-2-T15	●	○	20	20	125	20.4	15	S223 - 2	AKV-02-M6x22	ABPL-01	AAL-03-3
ADKT-HS223-R/L-2020-3-T17	●	○	20	20	125	20.3	17	S223 - 3	2004-M8x1x20	-	AAL-05-4

R: Sağ / Right / Rechts L: Sol/Left/Links

● Stokta / In Stock / Auf Lager ○ Stokta Yok / Non Stock Item / Kein Lagerartikel, Lieferzeit auf Anfrage

HRN Ucuna Uygun. / Compatible with HRN Insert. / Kompatibel mit HRN Wendeplatten.

Sipariş Örneği/Ordering Example/Bestellbeispiel

1 ad./pcs./stück ADKT-H-R-2020-3-T20

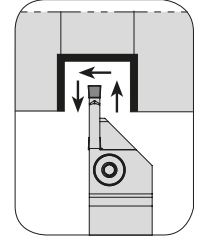
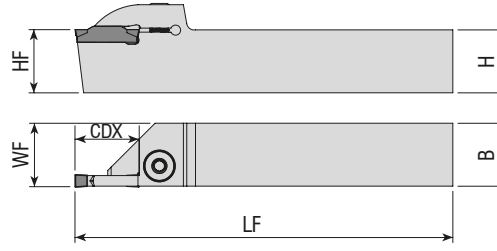

Takım Kodu Ordering Code Bestell-Bezeichnung	Stok Stock Lager		Takım Ölçüleri (mm) Dimension (mm) Abmessung (mm)					Kesici Uç Insert Wendeschneidplatte	Yedek Parçaları / Spare Parts / Ersatzteile		
	R	L	HF=H	B	LF	WF	CDX		Sıkma Vidası Screw Schraube	Pul Stamp Ring	Anahtar Allen Key Innensechskantschlüssel
ADKT-ZCC2-R/L-1616-2-T15	●	●	16	16	125	16.3	15	Z.BD - 2	AKV-02-M6x22	ABPL-01	AAL-03-3
ADKT-ZCC2-R/L-2020-2-T15	●	●	20	20	125	20.3	15				
ADKT-ZCC2-R/L-2525-2-T15	●	●	25	25	150	25.3	15				
ADKT-ZCC2-R/L-1616-2.5-T15	●	●	16	16	125	16.3	15	Z.ED - 2.5	2004-M8x1x20	-	AAL-05-4
ADKT-ZCC2-R/L-2020-2.5-T17	●	●	20	20	125	20.3	17				
ADKT-ZCC2-R/L-2525-2.5-T15	●	●	25	25	150	25.3	15				
ADKT-ZCC2-R/L-1616-3-T15	●	●	16	16	125	16.3	15	Z.FD - 3	2004-M8x1x20	-	AAL-05-4
ADKT-ZCC2-R/L-1616-3-T17	●	○	16	16	125	16.3	17				
ADKT-ZCC2-R/L-1616-3-T20	●	○	16	16	125	16.3	20				
ADKT-ZCC2-R/L-2020-3-T12	●	●	20	20	125	20.3	12	Z.GD - 4	2004-M8x1x20	-	AAL-05-4
ADKT-ZCC2-R/L-2020-3-T20	●	●	20	20	125	20.3	20				
ADKT-ZCC2-R/L-2020-3-R21	●	○	20	20	125	20.3	21				
ADKT-ZCC2-R/L-2020-3-R25	●	●	20	20	125	20.3	25	Z.HD - 5	2004-M8x1x20	-	AAL-05-4
ADKT-ZCC2-R/L-2525-3-T12	●	○	25	25	150	25.3	12				
ADKT-ZCC2-R/L-2525-3-T22	●	●	25	25	150	25.3	22				
ADKT-ZCC2-R/L-2525-3-R30	●	●	25	25	150	25.3	30	Z.KD - 6	2004-M8x1x20	-	AAL-05-4
ADKT-ZCC2-R/L-2020-4-T12	●	○	20	20	125	20.5	12				
ADKT-ZCC2-R/L-2020-4-T20	●	●	20	20	125	20.5	20				
ADKT-ZCC2-R/L-2525-4-T12	●	●	25	25	150	25.5	12	Z.HD - 5	2004-M8x1x20	-	AAL-05-4
ADKT-ZCC2-R/L-2525-4-T22	●	●	25	25	150	25.5	22				
ADKT-ZCC2-R/L-2020-5-T12	●	○	20	20	125	20.5	12				
ADKT-ZCC2-R/L-2020-5-T20	●	●	20	20	125	20.5	20	Z.KD - 6	2004-M8x1x20	-	AAL-05-4
ADKT-ZCC2-R/L-2525-5-T12	●	○	25	25	150	25.5	12				
ADKT-ZCC2-R/L-2525-5-T25	●	●	25	25	150	25.5	25				
ADKT-ZCC2-R/L-3232-5-T25	●	●	32	32	170	32.4	25	Z.KD - 6	2004-M8x1x20	-	AAL-05-4
ADKT-ZCC2-R/L-2020-6-T20	●	●	20	20	125	20.6	20				
ADKT-ZCC2-R/L-2525-6-T25	●	●	25	25	150	25.6	25				
ADKT-ZCC2-R/L-3232-6-T25	●	●	32	32	170	32.6	25	Z.KD - 6	2004-M8x1x20	-	AAL-05-4
ADKT-ZCC2-R/L-3232-6-T30	●	●	32	32	170	32.6	30				

R: Sağ / Right / Rechts L: Sol/Left/Links  
● Stokta / In Stock / Auf Lager ○ Stokta Yok / Non Stock Item / Kein Lagerartikel, Lieferzeit auf Anfrage  
ZCC Ucuna Uygunudur. / Compatible with ZCC Insert. / Kompatibel mit ZCC Wendeplatten.

Sipariş Örneği/Ordering Example/Bestellbeispiel  
1 ad./pcs./stück ADKT-ZCC2-R-1616-2-T15

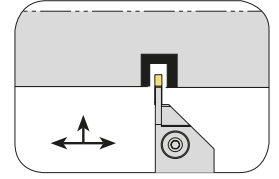
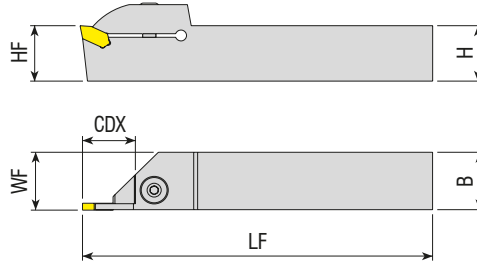

Takım Kodu Ordering Code Bestell-Bezeichnung	Stok Stock Lager		Takım Ölçüleri (mm) Dimension (mm) Abmessung (mm)				Kesici Uç Insert Wendeschneidplatte	Yedek Parçaları / Spare Parts / Ersatzteile			
	R	L	HF=H	B	LF	WF		CDX	Sıkma Vidası Screw Schraube	Pul Stamp Ring	Anahtar Allen Key Innerschlüssel
ADKT-ZCC1-R/L-2020-3-T20	●	○	20	20	125	20.3	20	ZQMX - 3	2004-M8x1x20	-	AAL-05-4
ADKT-ZCC1-R/L-2525-3-T22	●	○	25	25	150	25.3	22				
ADKT-ZCC1-R/L-2020-4-T20	●	○	20	20	125	20.4	20	ZQMX - 4	2004-M8x1x20	-	AAL-05-4
ADKT-ZCC1-R/L-2525-4-T22	●	○	25	25	150	25.4	22				

ZCC Ucuna Uygundur. / Compatible with ZCC Insert. / Kompatibel mit ZCC Wendeplatten.

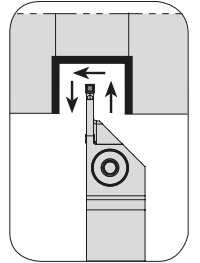
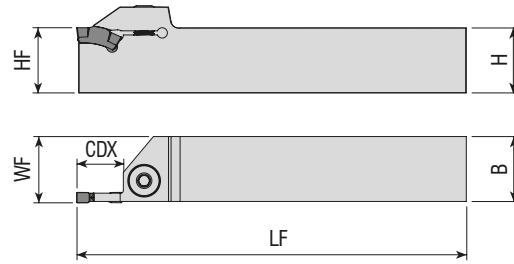

Takım Kodu Ordering Code Bestell-Bezeichnung	Stok Stock Lager		Takım Ölçüleri (mm) Dimension (mm) Abmessung (mm)				Kesici Uç Insert Wendeschneidplatte	Yedek Parçaları / Spare Parts / Ersatzteile			
	R	L	HF=H	B	LF	WF		CDX	Sıkma Vidası Screw Schraube	Pul Stamp Ring	Anahtar Allen Key Innerschlüssel
ADKT-ITG-R/L-2020-3-T8	●	●	20	20	125	20.3	8	TGM. - 3	2004-M8x1x20	-	AAL-05-4
ADKT-ITG-R/L-2525-3-T8	●	●	25	25	150	25.3	8				
ADKT-ITG-R/L-3232-3-T8	●	○	32	32	170	32.3	8	TGM. - 4	2004-M8x1x20	-	AAL-05-4
ADKT-ITG-R/L-2020-4-T9	●	●	20	20	125	20.4	9				
ADKT-ITG-R/L-2525-4-T17	●	●	25	25	150	25.4	17	TGM. - 5	2004-M8x1x20	-	AAL-05-4
ADKT-ITG-R/L-3232-4-T17	●	●	32	32	170	32.4	17				
ADKT-ITG-R/L-3232-5-T25	●	○	32	32	170	32.5	25				

R: Sağ / Right / Rechts L: Sol/Left/Links

● Stokta / In Stock / Auf Lager ○ Stokta Yok / Non Stock Item / Kein Lagerartikel, Lieferzeit auf Anfrage

ISCR Ucuna Uygundur. / Compatible with ISCR Insert. / Kompatibel mit ISCR Wendeplatten.

Sipariş Örneği/Ordering Example/Bestellbeispiel

1 ad./pcs./stück ADKT-ZCC1-R-2020-3-T20

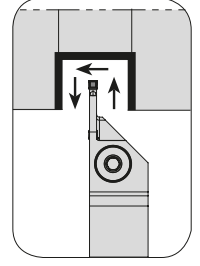
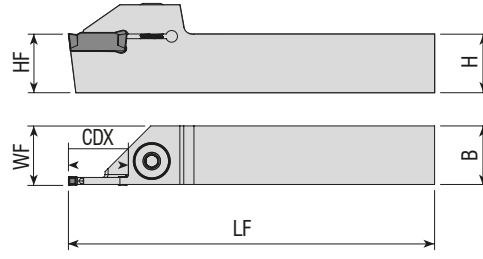

Takım Kodu Ordering Code Bestell-Bezeichnung	Stok Stock Lager		Takım Ölçüleri (mm) Dimension (mm) Abmessung (mm)					Kesici Uç Insert Wendeschneidplatte	Yedek Parçaları / Spare Parts / Ersatzteile			
	R	L	HF=H	B	LF	WF	CDX		Sıkma Vidası Screw Schraube	Pul Stamp Ring	Anahtar Allen Key Innensechskantschlüssel	
ADKT-I-R/L-1212-2-T15	●	●	12	12	125	16.3	15	DGN - 2	AKV-02-M6x22	ABPL-01	AAL-03-3	
ADKT-I-R/L-1616-2-T15	●	●	16	16	100	16.3	15					
ADKT-I-R/L-2020-2-T15	●	●	20	20	125	20.3	15					
ADKT-I-R/L-2525-2-T15	●	●	25	25	150	25.3	15					
ADKT-I-R/L-3232-2-T15	●	●	32	32	170	32.3	15					
ADKT-I-R/L-1212-3-T15	●	●	12	12	100	16.3	15	DGN - 3				
ADKT-I-R/L-1616-3-T15	●	●	16	16	125	16.4	15					
ADKT-I-R/L-2020-3-T20	●	●	20	20	125	20.4	20					
ADKT-I-R/L-2525-3-T22	●	●	25	25	150	25.4	22					
ADKT-I-R/L-3232-3-T22	●	●	32	32	170	32.4	22					
ADKT-I-R/L-2020-4-T20	●	●	20	20	125	20.4	20	DGN / GRP - 4	2004-M8x1x20	-	AAL-05-4	
ADKT-I-R/L-2525-4-T22	●	●	25	25	150	25.4	22					
ADKT-I-R/L-3232-4-T25	●	●	32	32	170	32.4	25					
ADKT-I-R/L-2020-5-T20	●	●	20	20	125	20.5	20	DGN / GRP - 5				
ADKT-I-R/L-2525-5-T25	●	●	25	25	150	25.5	25					
ADKT-IG-R/L-1616-3-T18	●	○	16	16	125	16.3	18	GRP - 3				
ADKT-IG-R/L-2020-3-R20	●	●	20	20	125	20.4	20					
ADKT-IG-R/L-2525-3-T22	●	●	25	25	150	25.4	22					
ADKT-IGI-R/L-2020-2-T15	●	●	20	20	125	20.3	15	GIM / GIP - 2	AKV-02-M6x22	ABPL-01	AAL-03-3	
ADKT-IGI-R/L-2525-2-T15	●	●	25	25	150	25.4	15					
ADKT-IGI-R/L-1616-3-T15	●	●	16	16	125	16.4	15	GIM / GIP - 3				
ADKT-IGI-R/L-2020-3-T20	●	●	20	20	125	20.4	20					
ADKT-IGI-R/L-2525-3-T22	●	●	25	25	150	25.4	22					
ADKT-IGI-R/L-2525-4-T22	●	●	25	25	150	25.5	22	GIM / GIP - 4	2004-M8x1x20	-	AAL-05-4	
ADKT-IGI-R/L-2525-5-T25	●	●	25	25	150	25.6	25					
ADKT-IGI-R/L-2525-8-T30	●	○	25	25	150	25.8	30	GIM / GIP - 8				
ADKT-IGTN-R/L-2525-5-T25	●	●	25	25	150	25.6	25	GTN - 5				
ADKT-IDC-R/L-2525-3-T21	●	○	25	25	150	25.4	21	DCE - 3				

R: Sağ / Right / Rechts L: Sol/Left/Links

● Stokta / In Stock / Auf Lager ○ Stokta Yok / Non Stock Item / Kein Lagerartikel, Lieferzeit auf Anfrage  
ISCR Ucuna Uygunudur. / Compatible with ISCR Insert. / Kompatibel mit ISCR Wendeplatten.

Sipariş Örneği/Ordering Example/Bestellbeispiel  
1 ad./pcs./stück ADKT-I-R-1212-2-T15



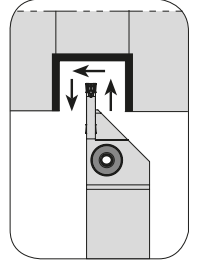
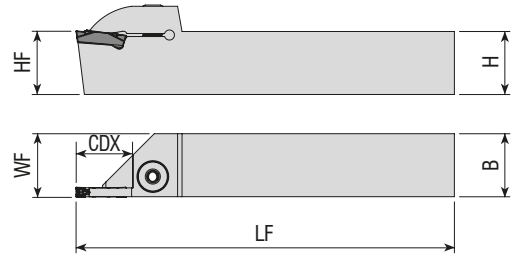

Takım Kodu Ordering Code Bestell-Bezeichnung	Stok Stock Lager		Takım Ölçüleri (mm) Dimension (mm) Abmessung (mm)				Kesici Uç Insert Wendeschneidplatte	Yedek Parçaları / Spare Parts / Ersatzteile			
	R	L	HF=H	B	LF	WF		CDX	Sıkma Vidası Screw Schraube	Pul Stamp Ring	Anahtar Allen Key Immersechslantschlüssel
ADKT-KM-R/L-2020-2-T15	●	●	20	20	125	20.3	15	A4 - 2	AKV-02-M6x22	ABPL-01	AAL-03-3
ADKT-KM-R/L-2525-2-T15	●	●	25	25	150	25.3	15				
ADKT-KM-R/L-2020-3-T20	●	●	20	20	125	20.4	20	A4 - 3	2004-M8x1x20	-	AAL-05-4
ADKT-KM-R/L-2525-3-T22	●	●	25	25	150	25.4	22				
ADKT-KM-R/L-2525-4-T22	●	●	25	25	150	25.5	22	A4 - 4			

KNMNTL Ucuna Uygunur. / Compatible with KNMNTL Insert. / Kompatibel mit KNMNTL Wendepplatten.

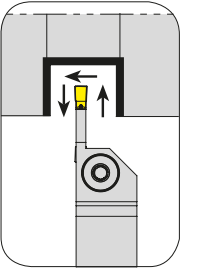
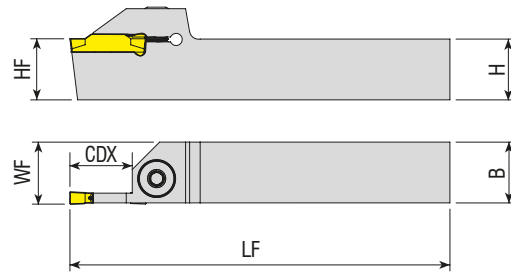

Takım Kodu Ordering Code Bestell-Bezeichnung	Stok Stock Lager		Takım Ölçüleri (mm) Dimension (mm) Abmessung (mm)				Kesici Uç Insert Wendeschneidplatte	Yedek Parçaları / Spare Parts / Ersatzteile			
	R	L	HF=H	B	LF	WF		CDX	Sıkma Vidası Screw Schraube	Pul Stamp Ring	Anahtar Allen Key Immersechslantschlüssel
ADKT-123-R/L-1212-1.5-R15	●	●	12	12	100	16.2	15	123 - 1.5	AKV-02-M6x22	ABPL-01	AAL-03-3
ADKT-123-R/L-1616-1.5-R15	●	●	16	16	125	16.3	15				
ADKT-123-R/L-1616-2-T15	●	●	16	16	125	16.3	15	123 - 2	AKV-02-M6x22	ABPL-01	AAL-03-3
ADKT-123-R/L-2020-2-T8	●	○	20	20	125	20.2	8				
ADKT-123-R/L-2020-2-T15	●	●	20	20	125	20.3	15	123 - 3	2004-M8x1x20	-	AAL-05-4
ADKT-123-R/L-2525-2-T15	●	●	25	25	150	25.3	15				
ADKT-123-R/L-2525-3-T15	●	●	25	25	150	25.4	22	123 - 4	2004-M8x1x20	-	AAL-05-4
ADKT-123-R/L-3232-2-T15	●	●	32	32	170	32.3	15				
ADKT-123-R/L-1616-3-T15	●	●	16	16	125	16.4	15	123 - 5	2004-M8x1x20	-	AAL-05-4
ADKT-123-R/L-2020-3-T20	●	●	20	20	125	20.4	20				
ADKT-123-R/L-2020-4-T20	●	●	20	20	125	20.4	20	123 - 6	2004-M8x1x20	-	AAL-05-4
ADKT-123-R/L-2525-4-T22	●	●	25	25	150	25.4	22				
ADKT-123-R/L-3232-4-T25	●	●	32	32	170	32.4	25	123 - 5	2004-M8x1x20	-	AAL-05-4
ADKT-123-R/L-2020-5-T20	●	●	20	20	125	20.5	20				
ADKT-123-R/L-2525-5-T25	●	●	25	25	150	25.5	25	123 - 6	2004-M8x1x20	-	AAL-05-4
ADKT-123-R/L-3232-6-T15	●	○	32	32	170	32.5	15				

R: Sağ / Right / Rechts L: Sol/Left/Links

● Stokta / In Stock / Auf Lager ○ Stokta Yok / Non Stock Item / Kein Lagerartikel, Lieferzeit auf Anfrage  
SNDVK Ucuna Uygunur. / Compatible with SNDVK Insert. / Kompatibel mit SNDVK Wendepplatten.

Sipariş Örneği/Ordering Example/Bestellbeispiel

1 ad./pcs./stück ADKT-KM-R-2020-2-T15

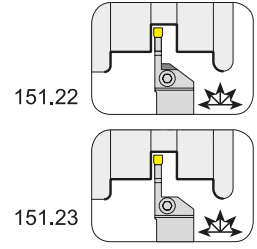
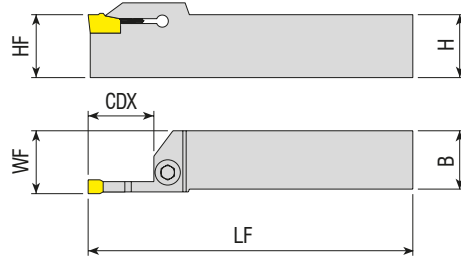

Takım Kodu Ordering Code Bestell-Bezeichnung	Stok Stock Lager		Takım Ölçüleri (mm) Dimension (mm) Abmessung (mm)					Kesici Uç Insert Wendeschneidplatte	Yedek Parçaları / Spare Parts / Ersatzteile		
	R	L	HF=H	B	LF	WF	CDX		Sıkma Vidası Screw Schraube	Pul Stamp Ring	Anahtar Allen Key Inmenschlüssel
ADKT-151.22-R/L-1616-2-T15	●	●	16	16	125	16.3	15	151.2 - 2	AKV-02-M6x22	ABPL-01	AAL-03-3
ADKT-151.22-R/L-2020-2-T15	●	●	20	20	125	20.3	15				
ADKT-151.22-R/L-2525-2-T15	●	●	25	25	150	25.3	15				
ADKT-151.22-R/L-1616-3-T15	●	●	16	16	125	16.4	15	151.2 - 3	2004-M8x1x20	-	AAL-05-4
ADKT-151.22-R/L-2020-3-T20	●	●	20	20	125	20.4	20				
ADKT-151.22-R/L-2525-3-T22	●	●	25	25	150	25.4	22				
ADKT-151.22-R/L-1616-4-T15	●	●	16	16	125	16.4	15	151.2 - 4	2004-M8x1x20	-	AAL-05-4
ADKT-151.22-R/L-2020-4-T20	●	●	20	20	125	20.4	20				
ADKT-151.22-R/L-2525-4-T22	●	●	25	25	150	25.4	22				
ADKT-151.22-R/L-2020-5-T20	●	●	20	20	125	20.5	20	151.2 - 5	2004-M8x1x20	-	AAL-05-4
ADKT-151.22-R/L-2525-5-T25	●	●	25	25	150	25.5	25				
ADKT-151.23-R/L-1616-2-T15	●	●	16	16	125	16.3	15	151.2 - 2	AKV-02-M6x22	ABPL-01	AAL-03-3
ADKT-151.23-R/L-2020-2-T15	●	●	20	20	125	20.3	15				
ADKT-151.23-R/L-2525-2-T15	●	●	25	25	150	25.3	15				
ADKT-151.23-R/L-1616-2.5-T15	●	●	16	16	125	16.3	15	151.2 - 2.5	2004-M8x1x20	-	AAL-05-4
ADKT-151.23-R/L-2020-2.5-T15	●	●	20	20	125	20.3	15				
ADKT-151.23-R/L-2525-2.5-T15	●	●	25	25	150	25.3	15				
ADKT-151.23-R/L-1212-3-T15	●	●	12	12	100	16.4	15	151.2 - 3	2004-M8x1x20	-	AAL-05-4
ADKT-151.23-R/L-1616-3-T15	●	●	16	16	125	16.4	15				
ADKT-151.23-R/L-2020-3-T20	●	●	20	20	125	20.4	20				
ADKT-151.23-R/L-2525-3-T20	●	●	25	25	150	25.4	20	151.2 - 4	2004-M8x1x20	-	AAL-05-4
ADKT-151.23-R/L-2525-3-T22	●	●	25	25	150	25.4	22				
ADKT-151.23-R/L-1616-4-T15	●	●	16	16	125	16.4	15				
ADKT-151.23-R/L-2020-4-T20	●	●	20	20	125	20.4	20	151.2 - 5	2004-M8x1x20	-	AAL-05-4
ADKT-151.23-R/L-2525-4-T22	●	●	25	25	150	25.4	22				
ADKT-151.23-R/L-2020-5-T20	●	●	20	20	125	20.5	20	151.2 - 5	2004-M8x1x20	-	AAL-05-4
ADKT-151.23-R/L-2525-5-T25	●	●	25	25	150	25.5	25				

R: Sağ / Right / Rechts L: Sol/Left/Links

● Stokta / In Stock / Auf Lager ○ Stokta Yok / Non Stock Item / Kein Lagerartikel, Lieferzeit auf Anfrage  
SNDVK Ucuna Uygundur. / Compatiple with SNDVK Insert. / Kompatibel mit SNDVK Wendeplatten.

Sipariş Örneği/Ordering Example/Bestellbeispiel  
1 ad./pcs./stück ADKT-151.22-R-1616-2-T15

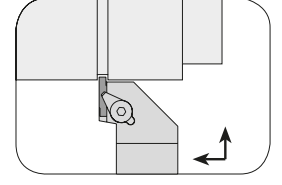
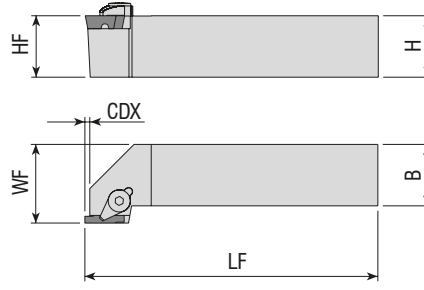

Takım Kodu Ordering Code Bestell-Bezeichnung	Stok Stock Lager		Takım Ölçüleri (mm) Dimension (mm) Abmessung (mm)					Kesici Uç Insert Wendeschneidplatte	Yedek Parçaları / Spare Parts / Ersatzteile				
	R	L	HF=H	B	LF	WF	CDX		Baskı Parçası Wedge Clamp Spannspratze	Sıkma Vidası Screw Schraube	Pul Stamp Ring	Anahtar Allen Key Innensechskantschlüssel	
ADKT-154.91-R/L-2020-3-T4	●	●	20	20	125	25	4	154.91 - 3	ACK-03	AKV-07-M6x22	APM-06	AAL-03-3	
ADKT-154.91-R/L 2525-3-T4	●	●	25	25	150	30.5	4						
ADKT-154.91-R/L 2020-5-T5	●	●	20	20	125	25	5	154.91 - 5	ACK-03	AKV-07-M6x22	APM-06	AAL-03-3	
ADKT-154.91-R/L 2525-5-T5	●	●	25	25	150	30.5	5						

SNDVK Ucuna Uygun. / Compatible with SNDVK Insert. / Kompatibel mit SNDVK Wendeplatten.

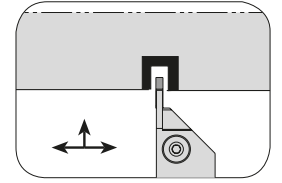
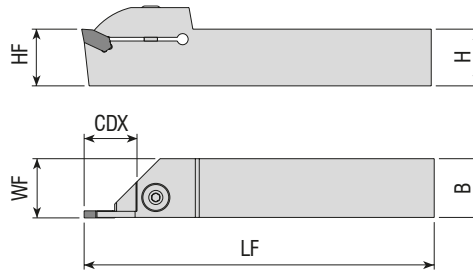

Takım Kodu Ordering Code Bestell-Bezeichnung	Stok Stock Lager		Takım Ölçüleri (mm) Dimension (mm) Abmessung (mm)					Kesici Uç Insert Wendeschneidplatte	Yedek Parçaları / Spare Parts / Ersatzteile			
	R	L	HF=H	B	LF	WF	CDX		Sıkma Vidası Screw Schraube	Pul Stamp Ring	Anahtar Allen Key Innensechskantschlüssel	
ADKT-ARN-R/L-2020-2-T15	●	●	20	20	125	20.3	15	LOMR. - 2	AKV-02-M6x22	ABPL-01	AAL-03-3	
ADKT-ARN-R/L-2525-2-T15	●	●	25	25	150	25.3	15					
ADKT-ARN-R/L-2020-3-T20	●	●	20	20	125	20.4	20	LOMR. - 3	2004-M8x1x20	-	AAL-05-4	
ADKT-ARN-R/L-2525-3-T22	●	●	25	25	150	25.4	22					

R: Sağ / Right / Rechts L: Sol/Left/Links

● Stokta / In Stock / Auf Lager ○ Stokta Yok / Non Stock Item / Kein Lagerartikel, Lieferzeit auf Anfrage

ARN Ucuna Uygun. / Compatible with ARN Insert. / Kompatibel mit ARN Wendeplatten.

Sipariş Örneği/Ordering Example/Bestellbeispiel

1 ad./pcs./stück ADKT-154.91-R-2020-3-T4

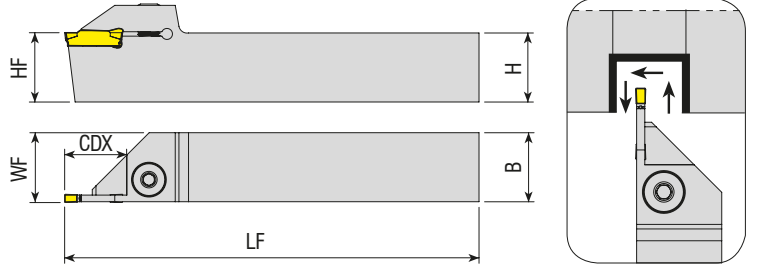

Takım Kodu Ordering Code Bestell-Bezeichnung	Stok Stock Lager		Takım Ölçüleri (mm) Dimension (mm) Abmessung (mm)				Kesici Uç Insert Wendeschneidplatte	Yedek Parçaları / Spare Parts / Ersatzteile			
	R	L	HF=H	B	LF	WF		CDX	Sıkma Vidası Screw Schraube	Pul Stamp Ring	Anahtar Allen Key Innensechskantschlüssel
ADKT-TD-R/L-1212-2-T15	●	●	12	12	100	12.3	15	TD. - 2	AKV-02-M6x22	ABPL-01	AAL-03-3
ADKT-TD-R/L-1616-2-T15	●	●	16	16	125	16.3	15				
ADKT-TD-R/L-2020-2-T9	●	○	20	20	125	20.3	9				
ADKT-TD-R/L-2020-2-T15	●	●	20	20	125	20.3	15				
ADKT-TD-R/L-2020-2-T20	●	○	20	20	125	20.3	20				
ADKT-TD-R/L-2525-2-T17	●	●	25	25	150	25.3	17	TD. - 3	2004-M8x1x20	-	AAL-05-4
ADKT-TD-R/L-1212-3-T15	●	●	12	12	100	12.4	15				
ADKT-TD-R/L-1616-3-T15	●	●	16	16	125	16.4	15				
ADKT-TD-R/L-2020-3-T20	●	●	20	20	125	20.4	20				
ADKT-TD-R/L-2020-3-T25	●	○	20	20	125	20.4	25				
ADKT-TD-R/L-2020-3-T30	●	●	20	20	125	20.4	30				
ADKT-TD-R/L-2525-3-T9	●	●	25	25	150	25.4	9				
ADKT-TD-R/L-2525-3-T22	●	●	25	25	150	25.4	22				
ADKT-TD-R/L-2525-3-T25	●	●	25	25	150	25.4	25				
ADKT-TD-R/L-2525-3-T30	●	○	25	25	150	25.4	30				
ADKT-TD-R/L-3232-3-T25	●	○	32	32	170	32.4	25	TD. - 4			
ADKT-TD-R/L-2525-4-T22	●	●	25	25	150	25.5	22				
ADKT-TD-R/L-2525-4-T30	●	○	25	25	150	25.5	30				
ADKT-TD-R/L-2525-5-T25	●	●	25	25	150	25.5	25	TD. - 5			

TGTC Ucuna Uyundur. / Compatible with TGTC Insert. / Kompatibel mit TGTC Wendepplatten.

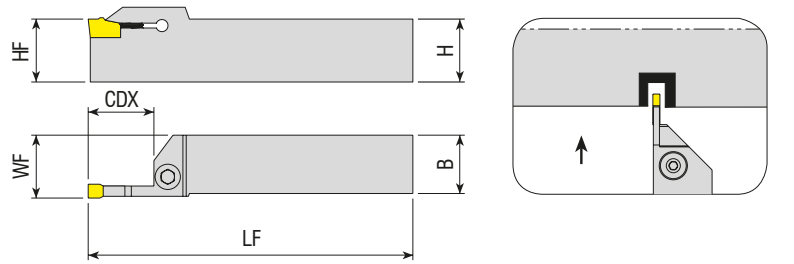

Takım Kodu Ordering Code Bestell-Bezeichnung	Stok Stock Lager		Takım Ölçüleri (mm) Dimension (mm) Abmessung (mm)				Kesici Uç Insert Wendeschneidplatte	Yedek Parçaları / Spare Parts / Ersatzteile			
	R	L	HF=H	B	LF	WF		CDX	Sıkma Vidası Screw Schraube	Pul Stamp Ring	Anahtar Allen Key Innensechskantschlüssel
ADKT-SWC-R/L-2020-2-T25	●	○	20	20	125	20.3	25	WCF - 2	AKV-02-M6x22	ABPL-01	AAL-03-3
ADKT-SWC-R/L-2020-3-T25	●	○	20	20	125	20.4	25	WCF - 3	2004-M8x1x20	-	AAL-05-4

R: Sağ / Right / Rechts L: Sol/Left/Links

● Stokta / In Stock / Auf Lager ○ Stokta Yok / Non Stock Item / Kein Lagerartikel, Lieferzeit auf Anfrage  
SMTM Ucuna Uyundur. / Compatible with SMTM Insert. / Kompatibel mit SMTM Wendepplatten.

Sipariş Örneği/Ordering Example/Bestellbeispiel  
1 ad./pcs./stück ADKT-TD-R-1212-2-T15

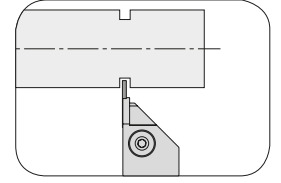
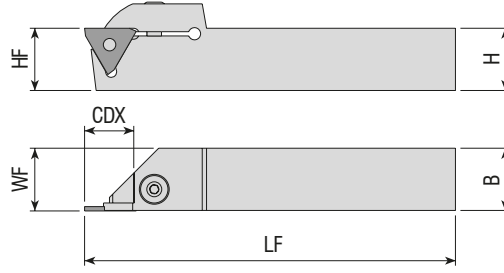

Takım Kodu Ordering Code Bestell-Bezeichnung	Stok Stock Lager		Takım Ölçüleri (mm) Dimension (mm) Abmessung (mm)				Kesici Uç Insert Wendeschneidplatte	Yedek Parçaları / Spare Parts / Ersatzteile				
	R	L	HF=H	B	LF	WF		CDX	Sıkma Vidası Screw Schraube	Baskı Pabucu Wedge Clamp Spannpratze	Sekman Ring Feder	Anahtar Allen Key Innensechskantschlüssel
ADKT-H22-R/L-1616-(0.5-2)-T4	●	●	16	16	125	16.2	4	S312 - (0.5-2)	AKV-29-M6x29	AKK-04	AS-01	AAL-03-3
ADKT-H22-R/L-2020-(0.5-2)-T4	●	●	20	20	125	20.2	4					
ADKT-H22-R/L-2525-(0.5-2)-T4	●	●	25	25	150	25.2	4					

HRN Ucuna Uygunudur. / Compatible with HRN Insert. / Kompatibel mit HRN Wendeplatten.

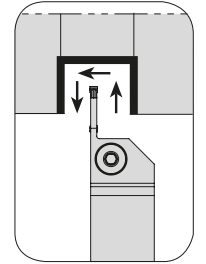
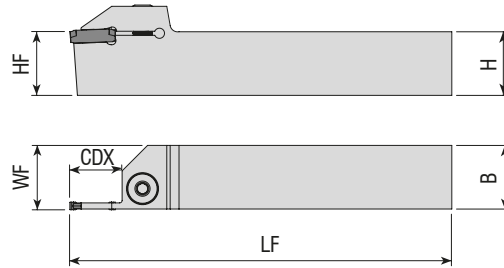

Takım Kodu Ordering Code Bestell-Bezeichnung	Stok Stock Lager		Takım Ölçüleri (mm) Dimension (mm) Abmessung (mm)				Kesici Uç Insert Wendeschneidplatte	Yedek Parçaları / Spare Parts / Ersatzteile			
	R	L	HF=H	B	LF	WF		CDX	Sıkma Vidası Screw Schraube	Pul Stamp Ring	Anahtar Allen Key Innensechskantschlüssel
ADKT-LGC-R/L-1616-2-D40	●	●	16	16	125	16.2	20	GCTX - 2	AKV-02-M6x22	ABPL-01	AAL-03-3
ADKT-LGC-R/L-2020-2-D40	●	●	20	20	125	20.2	20				
ADKT-LGC-R/L-2525-2-D40	●	●	25	25	150	25.2	20				
ADKT-LGC-R/L-1616-3-T20	●	●	16	16	125	16.3	20	GCTX - 3	2004-M8x1x20	-	AAL-05-4
ADKT-LGC-R/L-2020-3-T20	●	●	20	20	125	20.3	20				
ADKT-LGC-R/L-2525-3-T20	●	●	25	25	150	25.3	20				

R: Sağ / Right / Rechts L: Sol/Left/Links

● Stokta / In Stock / Auf Lager ○ Stokta Yok / Non Stock Item / Kein Lagerartikel, Lieferzeit auf Anfrage

LMN Ucuna Uygunudur. / Compatible with LMN Insert. / Kompatibel mit LMN Wendeplatten.

Sipariş Örneği/Ordering Example/Bestellbeispiel

1 ad./pcs./stück ADKT-H22-R-1616-(0.5-2)T16

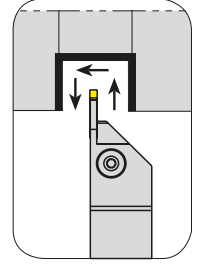
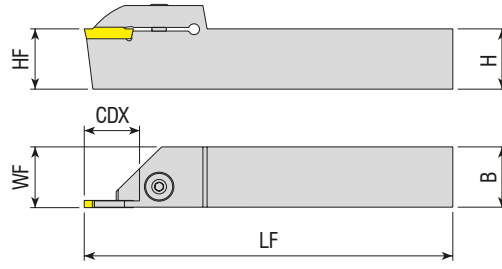

Takım Kodu Ordering Code Bestell-Bezeichnung	Stok Stock Lager		Takım Ölçüleri (mm) Dimension (mm) Abmessung (mm)					Kesici Uç Insert Wendeschneidplatte	Yedek Parçaları / Spare Parts / Ersatzteile		
	R	L	HF=H	B	LF	WF	CDX		Sıkma Vidası Screw Schraube	Pul Stamp Ring	Anahtar Allen Key Innerschraubschlüssel
ADKT-WGX16-R/L-2020-2-R16	●	○	20	20	125	20.3	16	GX16. - 2	AKV-02-M6x22	ABPL-01	AAL-03-3
ADKT-WGX16-R/L-2525-2-R16	●	○	25	25	150	20.3	16				
ADKT-WGX24-R/L-2020-3-T20	●	●	20	20	125	20.3	20	GX24. - 3	2004-M8x1x20	-	AAL-05-4
ADKT-WGX24-R/L-2525-3-T22	●	●	25	25	150	25.3	22				
ADKT-WGX24-R/L-3232-3-T22	●	○	32	32	170	32.3	22	GX24. - 4	2004-M8x1x20	-	AAL-05-4
ADKT-WGX24-R/L-2525-4-T22	●	●	25	25	150	25.4	22				
ADKT-WGX24-R/L-2525-5-T25	●	●	25	25	150	25.5	25	GX24. - 5	2004-M8x1x20	-	AAL-05-4
ADKT-WGX24-R/L-3232-5-T25	●	●	32	32	170	32.5	25				

WLTR Ucuna Uygundur. / Compatible with WLTR Insert. / Kompatibel mit WLTR Wendeplatten.

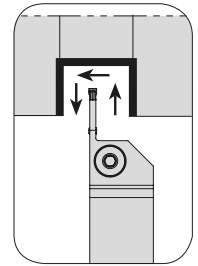
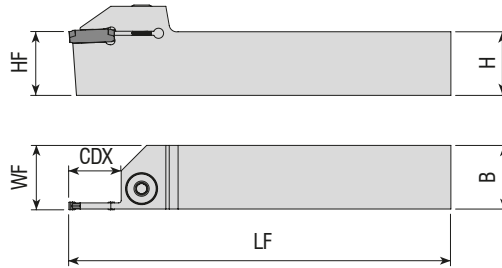

Takım Kodu Ordering Code Bestell-Bezeichnung	Stok Stock Lager		Takım Ölçüleri (mm) Dimension (mm) Abmessung (mm)					Kesici Uç Insert Wendeschneidplatte	Yedek Parçaları / Spare Parts / Ersatzteile		
	R	L	HF=H	B	LF	WF	CDX		Sıkma Vidası Screw Schraube	Pul Stamp Ring	Anahtar Allen Key Innerschraubschlüssel
ADKT-GP-R/L-2020-2-T15	●	●	20	20	125	20.2	15	GP - 2	AKV-02-M6x22	ABPL-01	AAL-03-3
ADKT-GP-R/L-2525-2-T15	●	●	25	25	150	25.2	15				
ADKT-GP-R/L-2020-3-T20	●	●	20	20	125	20.3	20	GP - 3	2004-M8x1x20	-	AAL-05-4
ADKT-GP-R/L-2525-3-T22	●	●	25	25	150	25.3	22				
ADKT-GP-R/L-2525-4-T22	●	●	25	25	150	25.4	22	GP - 4	2004-M8x1x20	-	AAL-05-4
ADKT-GP-R/L-2525-5-T25	●	●	25	25	150	25.5	25				

R: Sağ / Right / Rechts L: Sol/Left/Links  
● Stokta / In Stock / Auf Lager ○ Stokta Yok / Non Stock Item / Kein Lagerartikel, Lieferzeit auf Anfrage  
PLBT Ucuna Uygundur. / Compatible with PLBT Insert. / Kompatibel mit PLBT Wendeplatten.

Sipariş Örneği/Ordering Example/Bestellbeispiel  
1 ad./pcs./stück ADKT-WGX24-R-2525-3-T22

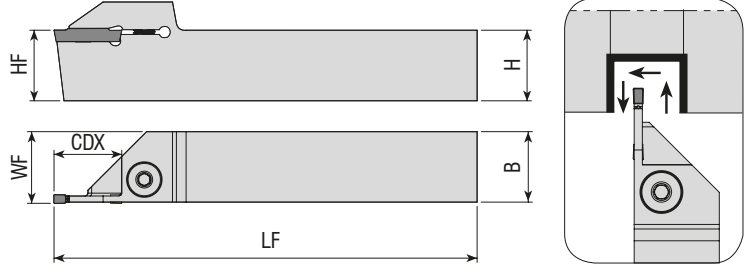

Takım Kodu Ordering Code Bestell-Bezeichnung	Stok Stock Lager		Takım Ölçüleri (mm) Dimension (mm) Abmessung (mm)					Kesici Uç Insert Wendeschneidplatte	Yedek Parçaları / Spare Parts / Ersatzteile		
	R	L	HF=H	B	LF	WF	CDX		Sıkma Vidası Screw Schraube	Pul Stamp Ring	Anahtar Allen Key Innerschlüssel
ADKT-CD-R/L-2020-3-R20	●	○	20	20	125	20.3	20	GX24 0300	2004-M8x1x20	-	AAL-05-4
ADKT-CD-R/L-2525-3-R23	●	○	25	25	150	25.3	23				

CRTZT Ucuna Uygunur. / Compatible with CRTZT Insert. / Kompatibel mit CRTZT Wendeplatten.

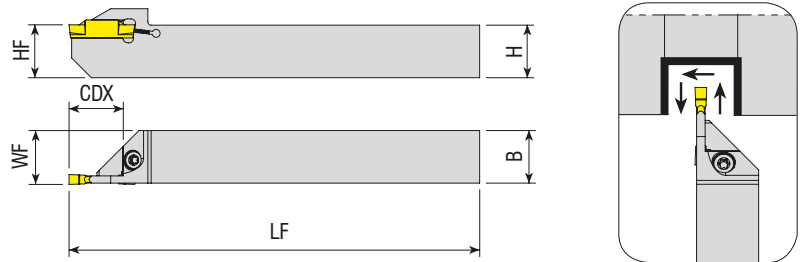

Takım Kodu Ordering Code Bestell-Bezeichnung	Stok Stock Lager		Takım Ölçüleri (mm) Dimension (mm) Abmessung (mm)					Kesici Uç Insert Wendeschneidplatte	Yedek Parçaları / Spare Parts / Ersatzteile		
	R	L	HF=H	B	LF	WF	CDX		Sıkma Vidası Screw Schraube	Pul Stamp Ring	Anahtar Allen Key Innerschlüssel
ADKT-TD-R/L-1212-2-T12-K-S	●	●	12	12	125	12.2	12	TD. - 2	4015-M4x11	-	80-T15
ADKT-TD-R/L-1616-2-T16-K-S	●	●	16	16	125	16.2	16				
ADKT-TD-R/L-1212-3-T12-K-S	●	●	12	12	125	12.3	12	TD. - 3	-	-	-
ADKT-TD-R/L-1616-3-T16-K-S	●	●	16	16	125	16.3	16				

R: Sağ / Right / Rechts L: Sol/Left/Links  
● Stokta / In Stock / Auf Lager ○ Stokta Yok / Non Stock Item / Kein Lagerartikel, Lieferzeit auf Anfrage  
TGTC Ucuna Uygunur. / Compatible with TGTC Insert. / Kompatibel mit TGTC Wendeplatten.

Sipariş Örneği/Ordering Example/Bestellbeispiel  
1 ad./pcs./stück ADKT-CD-R-2020-3-R20