



*konusulan
the spoken kalite...
quality...*

KARTUŞLAR

KARTUŞLAR
CARTRIDGE
KURZDREHHALTER



S

1

T

2

F

3

C

4

R

5

12

6

C

7



A

8

16

9

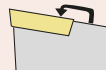

1 Sıkma Tipi / Method of Mounting of Insert / Klemmsystem

		
Deliksiz Üstten Sıkma Top Clamping Without Hole Pratzenklemmung	Delikten Levye ile Sıkma Hole Clamping (Lever Lock) Kniehebel-Spannsystem	Vida ile Sıkma Screw on Schrauben-Spannsystem
C	P	S

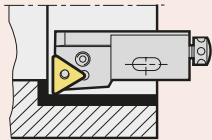
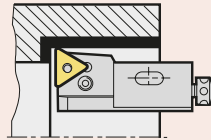
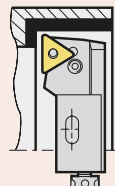
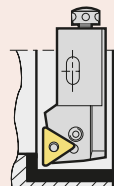
5 Kesme Yönü / Cutting Direction / Halterausführung

	
	
R	L

2 Uç Tipi / Type of Insert / Plattenform

		
C	S	T

3 Yanaşma Açısı / Tool Holder Shape Bar Geometry / Anstellwinkel

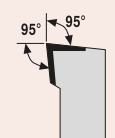
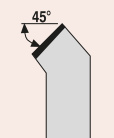
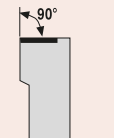
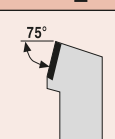
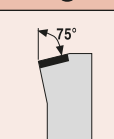
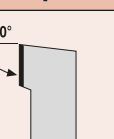
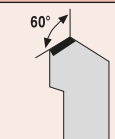
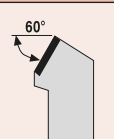
		
L	S	F
		
R	K	G
		
W	T	

6 Kesme Kenar Yüksekliği / Cutting Edge Height / Drehhalterhöhe





7 Kartuş Kodu / Cartridge Code / Kurzdrehhalter Bezeichnung

C (Kartuş / Cartridge Code / Kurzdrehhalter Bezeichnung)
--



8 Kartuş Tipi / Cartridge Type / Art der Kurzdrehhalter

A (ISO 5611)

4 Serbest Uç Açısı / Insert Clearance Angle / Freiwinkel

		
C	P	N

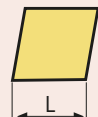
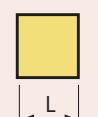
9 Kesme Kenar Uzunluğu / Cutting Edge Length / Halterausführung

		
--	---	---

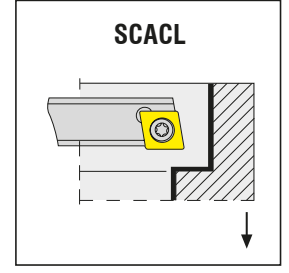
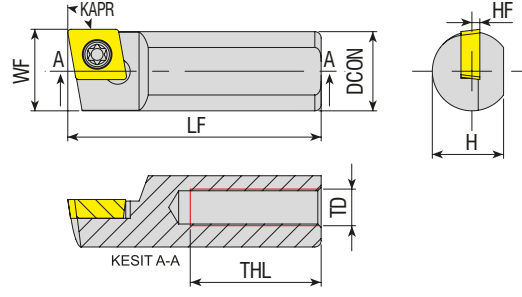

Takım Kodu Ordering Code Bestell-Bezeichnung	Stok Stock Lager		Takım Ölçüleri (mm) Dimension (mm) Abmessung (mm)							Kesici Uç Insert Wendeschneidplatte	Yedek Parçaları / Spare Parts / Ersatzteile	
	R	L	DCON	H	LF	THL	HF	WF	TD		Sıkma Vidası Screw Schraube	Tork Anahtar Torx Key Torx-Schlüssel
S10X SCACR/L 06	●	●	10	9	25	10	1	10.3	M5x0.8	CC.. 0602..	4008-M2.5x6	80-T08
S10A SCACR/L 06	●	●	10	9	32	15	1	10.3	M5x0.8			
S1018 SCACR/L 06	○	●	10	9	18	8	1	9.8	M5x0.8			
S1065 SCACR/L 06	○	●	10	9	65	5	1	10.3	M5x0.8			
S10C SCACR/L 06	●	●	10	9	50	25	1	10.3	M5x0.8			
S12B SCACR/L 06	●	●	12	11	40	25	1	12.3	M5x0.8			
S12D SCACR/L 06	●	●	12	11	60	25	1	12.3	M5x0.8			
S12D SCACR/L 09	●	●	12	11	60	25	2	12.2	M5x0.8			
S1265 SCACR/L 09	○	●	12	11	65	25	2	12.3	M5x0.8			
S12H SCACR/L 09	●	●	12	11	100	25	2	12.2	M5x0.8			
S15C SCACR/L 09	●	●	15	14	50	25	2	15.3	M8x1.25	CC.. 09T3..	4015-M3.5x8	80-T15
S1554 SCACR/L 09	○	●	15	14	54	25	2	15.3	M8x1.25			
S15E SCACR/L 09	○	●	15	14	70	45	2	15.3	M8x1.25			
S15D SCACR/L 09	○	●	15	14	60	30	2	15.3	M8x1.25			
S16A SCACR/L 09	●	●	16	15	32	15	2	16.5	M6x1			
S16B SCACR/L 09	●	●	16	15	40	20	2	16.5	M6x1			
S16C SCACR/L 09	○	●	16	15	50	25	2	16.5	M6x1			
S16D SCACR/L 09	●	●	16	15	60	30	2	16.5	M6x1			
S16E SCACR/L 09	○	●	16	15	70	30	2	16.5	M6x1			
S16G SCACR/L 09	●	●	16	15	90	30	2	16.5	M6x1			
S16H SCACR/L 09	○	●	16	15	100	35	4	16.5	M6x1			
S1868 SCACR/L 09	○	●	18	17	68	30	2	18.5	M8x1.25	CC.. 1204..	1020-M5x11	80-T20
S18E SCACR/L 09	●	●	18	17	70	30	2	18.5	M8x1.25			
S1888 SCACR/L 09	○	●	18	17	88	30	2	18.5	M8x1.25			
S18105 SCACR/L 09	○	●	18	17	105	30	2	18.5	M8x1.25			
S18175 SCACR/L 09	○	●	18	17	175	30	2	18.5	M8x1.25			
S20E SCACR/L 09	●	●	20	18.3	70	30	2	20.5	M6x1			
S20E SCACR/L 12	●	●	20	18.3	70	30	2	20.5	M6x1			
S20H SCACR/L 12	●	●	20	18.3	100	30	2	20.5	M6x1			

R: Sağ / Right / Rechts L: Sol/Left/Links

● Stokta / In Stock / Auf Lager ○ Stokta Yok / Non Stock Item / Kein Lagerartikel, Lieferzeit auf Anfrage

Sipariş Örneği/Ordering Example/Bestellbeispiel

1 ad./pcs./stück S10X SCACR 06

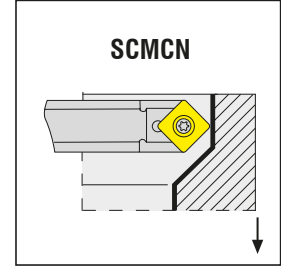
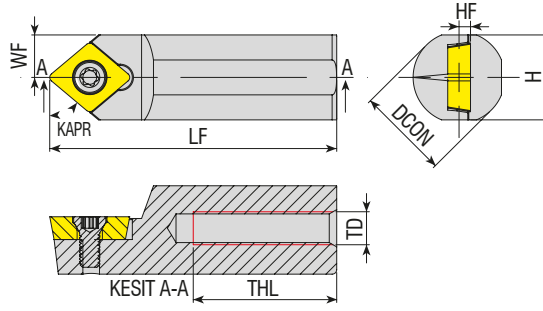

Takım Kodu Ordering Code Bestell-Bezeichnung	Stok Stock Lager	Takım Ölçüleri (mm) Dimension (mm) Abmessung (mm)						Kesici Uç Insert Wendeschneidplatte	Yedek Parçaları / Spare Parts / Ersatzteile		
		DCON	H	LF	THL	HF	WF		TD	Sıkma Vidası Screw Schraube	Tork Anahtar Torx Key Torx-Schlüssel
S10X SCMCN 06	●	10	9	25	10	1	5	M5x0.8	CC.. 0602..	4008-M2.5x6	80-T08
S12D SCMCN 06	●	12	11	60	25	1	6	M5x0.8			
S16C SCMCN 09	●	16	15	50	25	2	8	M6x1	CC.. 09T3..	4015-M3.5x11	80-T15
S16D SCMCN 09	●	16	15	60	25	4	8	M6x1			

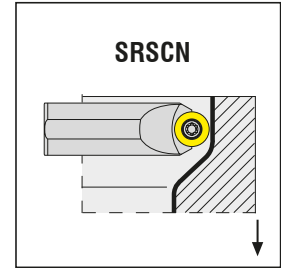
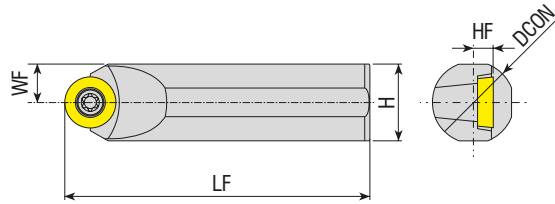

Takım Kodu Ordering Code Bestell-Bezeichnung	Stok Stock Lager	Takım Ölçüleri (mm) Dimension (mm) Abmessung (mm)					Kesici Uç Insert Wendeschneidplatte	Yedek Parçaları / Spare Parts / Ersatzteile	
		DCON	H	WF	HF	LF		Sıkma Vidası Screw Schraube	Tork Anahtar Torx Key Torx-Schlüssel
S12D SRSCN 10	●	12	11	6	3.9	60	RC. 10T3	4015-M3.5x9	80-T15
S14D SRSCN 10	●	14	13	7	3.9	60		4015-M3.5x11	
S16D SRSCN 10	●	16	15	8	3.9	60			

R: Sağ / Right / Rechts L: Sol/Left/Links
● Stokta / In Stock / Auf Lager ○ Stokta Yok / Non Stock Item / Kein Lagerartikel, Lieferzeit auf Anfrage

Sipariş Örneği/Ordering Example/Bestellbeispiel
1 ad./pcs./stück S10X SCMCN 06

➤ **S-TİP REKTEFİYE KARTUŞLARI**
S-TYPE ENGINE OVERHAUL CARTRIDGE
S-SYSTEM KURZDREHHALTER FÜR DIE MOTORINSTANDHALTUNG

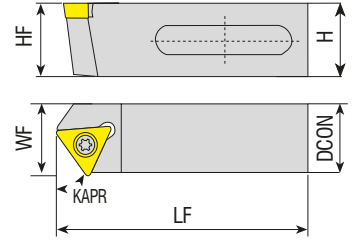

Takım Kodu Ordering Code Bestell-Bezeichnung	Stok Stock Lager		Takım Ölçüleri (mm) Dimension (mm) Abmessung (mm)				Kesici Uç Insert Wendeschneidplatte	Yedek Parçaları / Spare Parts / Ersatzteile		
	R	L	DCON	H	HF	LF		WF	Sıkma Vidası Screw Schraube	Tork Anahtar Torx Key Torx-Schlüssel
STXCR/L 2020 B16	○	●	20	20	20	45	20	TC.. 16T3..	4015-M3.5x11	80-T15
STXCR/L 2020 E16	○	●	20	20	20	70	20			
STXCR/L 2020 B16-SA	○	●	20	10	20	45	20			
STXCR/L 2020 E16-SA	○	●	20	10	20	70	20			
STXCR/L 2020 B16-PL	○	●	20	10	20	45	20			
STXCR/L 2020 E16-PL	○	●	20	10	20	70	20			
STXCR/L 2020 H16-PL	○	●	20	10	20	100	20			

➤ **S-SİSTEM KARTUŞLAR**
S-SYSTEM CARTRIDGE
S-SYSTEM KURZDREHHALTER

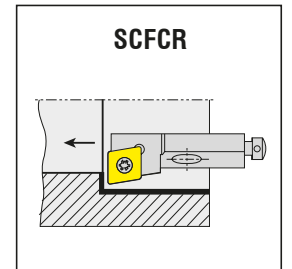
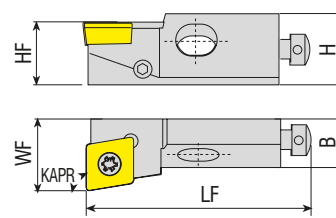
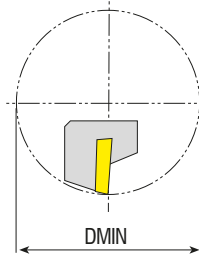

Takım Kodu Ordering Code Bestell-Bezeichnung	Stok Stock Lager		Takım Ölçüleri (mm) Dimension (mm) Abmessung (mm)					Kesici Uç Insert Wendeschneidplatte	Yedek Parçaları / Spare Parts / Ersatzteile				
	R	L	HF	H	B	LF	WF		DMIN	Altlık Shim Unterlage	Altlık Vidası Shim Screw Schraube für Unterlage	Sıkma Vidası Screw Schraube	Tork Anahtar Torx Key Torx-Schlüssel
SCFCR/L 06CA 06	●	●	6	8.5	6	25	8	≥20	CC.T 060204	-	-	4008-M2.5x6	80-T08
SCFCR/L 08CA 06	●	●	8	11	8	32	10	≥25					
SCFCR/L 10CA 09	●	●	10	15	11	50	14	≥40					
SCFCR/L 12CA 12	●	○	12	20	15	55	20	≥50					
SCFCR/L 16CA 12	●	●	16	21	20	63	25	≥60					
									AACN-2-0003	AAV-10-M4.5x8	4020-M4.5x12	80-T20	

R: Sağ / Right / Rechts L: Sol/Left/Links

● Stokta / In Stock / Auf Lager ○ Stokta Yok / Non Stock Item / Kein Lagerartikel, Lieferzeit auf Anfrage

Sipariş Örneği/Ordering Example/Bestellbeispiel
1 ad./pcs./stück STXCR 2020 B16



www.akkо.com.tr