



# DIN ISO 7388-1

## A - AD - AD/B

### Werkzeugaufnahmen

Toolholders

Porte-outils

Takım Tutucular

INHALTSVERZEICHNIS / INDEX	Seite / Page
<b>Spannzangenfutter - Collet chuck</b> Mandrin à pincés - Pens başlığı	1.05 - 1.11
<b>Ausrichtbares Spann Futter - Adjustable tool holder</b> Tige de réglage - Hassas ayarlanabilir pens tutucu	1.12
<b>Kraftspannfutter - Power milling chuck</b> Mandrin de fraiseage - Bilyalı pens tutucu	1.13
<b>Fräseraufnahmen - End mill holder</b> Porte-fraises - Veldon tutucu	1.14 - 1.23
<b>Spannzangenfutter - Pull type collet chuck</b> Mandrin de serrage de précision - Çektirmeli pens başlığı	1.24 - 1.26
<b>Morsekegel Aufnahmen - Morse taper adapter</b> Douilles intermédiaires - Mors adaptörü	1.27
<b>Zwischenhülsen mit Anzugsgewinde - Morse taper adapter</b> Douilles intermédiaires - Mors adaptörü çektirmeli	1.28
<b>Reduzierungen - Reduction sleeves</b> Douilles de réduction - Redüksiyon	1.28
<b>Kombi-Aufsteckfräserdorne - Combi shell mill holder</b> Porte-fraises à double usage pour fraises - Kombine malafa	1.29 - 1.32
<b>Quernut-Aufsteckdorne - Shell mill holder</b> Porte-fraises à surfacer - Alın kamalı malafa	1.33 - 1.36
<b>Aufschraubfräser - Milling cutter arbors</b> Axess coupeur fraiseage - Vidalı takım tutucu	1.37 - 1.39
<b>Bohrerhalter E1 - Boring holder E1</b> Porte foret E1 - Takma uçlu drill tutucu E1	1.40
<b>Bohrfutteraufnahme - Drill chuck</b> Arbre pour mandrin de perçage - Mandren malafası	1.40
<b>NC -Bohrfutter - NC - Drill chuck</b> Mandrin de perçage - NC mandren malafası	1.41
<b>Gewindeschneidfutter - Quick change tapping chuck</b> Appareil à tarauder - Kılavuz çekme başlığı	1.42
<b>Rohlinge - Blanks</b> Barre d'alésage - Özel takım yapma amaçlı yarı mamul	1.43
<b>Kontrolldorne - Test arbors</b> Mandrin de contrôle - Kontrol mastarı	1.43
<b>Schrumpffutter - Shrink chuck</b> Mandrin de fretage - Isıtmalı takım tutucu	1.44 - 1.48
<b>Hydro - Dehnspannfutter - Hydraulic expansion chuck</b> Mandrin expansibles - Hidrolik takım tutucu	1.49 - 1.52



**Mit EROGLU erhalten Sie auch Semi-Standard – in der gleichen Qualität!**

**With EROGLU you receive semi-standard, too – within the same quality!**

**Avec EROGLU vous recevez aussi semi-standard – avec la même qualité!**

**Özel ürün seçenekleri ile EROĞLU kalitesi hep sizinle...**

## . ERP

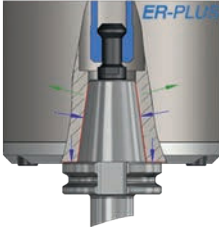

SK Halter können als ER-PLUS (Doppelkontakt) gefertigt werden  
(Beispiel Bestellnummer: 402.02.10.63.ERP)

SK products can be produced as ER-PLUS (Dual face contact)

(Example order code no: 402.02.10.63.ERP)

Mandrins SK peut être fabrique comme version ER-PLUS (double contact)

(Exemple commande no: 402.02.10.63.ERP)

Tüm SK ürünler ER-PLUS (Çift yüzey temaslı) olarak üretilebilir.

(Örnek sip. Nr. : 402.02.10.63.ERP)

## . ON



Alle SK30 Aufnahmen auf seite 1.06 - 1.14 - 1.29 - 1.44 können für  
Holzbearbeitungsmaschinen als Typ "ON" (ohne Mitnehmernuten und ohne  
Positionierungskerbe) bestellt werden. (Beispiel Bestellnummer: 302.02.10.70.ON)

All SK30 chucks at page 1.06 - 1.14 - 1.29 - 1.44 can be ordered for wooden  
machines as type "ON" (without driving grooves and without positioning mark).  
(Example order code no: 302.02.10.70.ON)

Tous les mandrins SK30 à la page 1.06 - 1.14 - 1.29 - 1.44 peuvent également être  
commandés pour les machines à bois de type "ON" (sans rainure de clavette et  
sans marquage de positionnement). (Exemple commande no: 302.02.10.70.ON)

Sayfa numaraları belirtilen takım tutucular için SK30 kama kanalsız üretilebilir.

Sayfa 1.06 - 1.14 - 1.29 - 1.44 (Örnek sip. Nr. : 302.02.10.70.ON)

## . G2.5 x ...

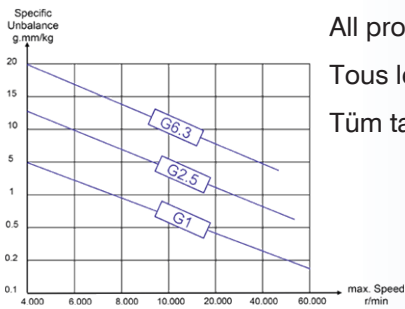

Alle Artikel können mit dem angegebenen Maximalwert feingewuchtet werden.

All products can be produced in the specified maximum balance value.

Tous les articles peuvent être spécifiés avec le maximum de précision équilibrée.

Tüm takım tutucular belirlenen max. balans değerlerinde üretilebilir.

## . CAT



Alle Werkzeugaufnahmen können auch gemäß CAT Norm gefertigt werden.

All tool holders can be produced in accordance with CAT ASME B5.50 (ANSI B5.50)

Tous les porte-outils peuvent être fabriqués aussi selon le standard CAT.

Tüm takım tutucular CAT ASME B5.50 (ANSI B5.50) normuna uygun olarak  
üretilebilir.

## ER-PLUS Dual face contact

## ER-PLUS double contact

## ER-PLUS Çift yüzey teması

Standard Werkzeug-System  
Standard Tooling System  
système d'outils standard  
Standart Takım sistemi  
Abstand / Distance / Distance / Mesafe

ER-PLUS Werkzeug-System  
ER-PLUS Tooling System  
ER-PLUS système d'outils  
ER-PLUS Takım Sistemi  
Kontakt / Contact / Contact / Teması

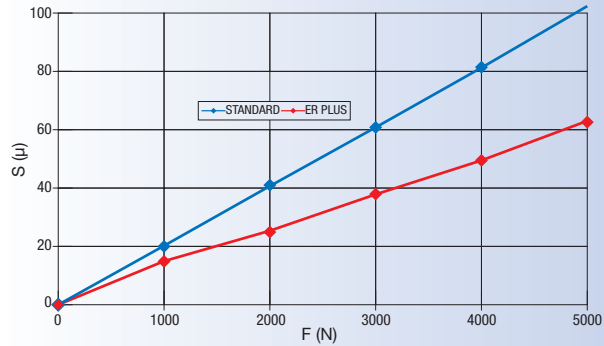
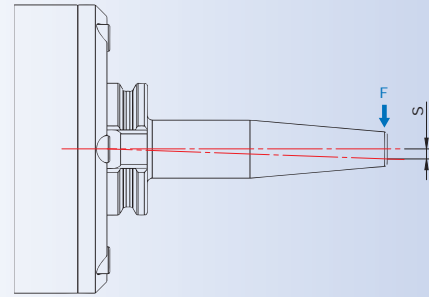
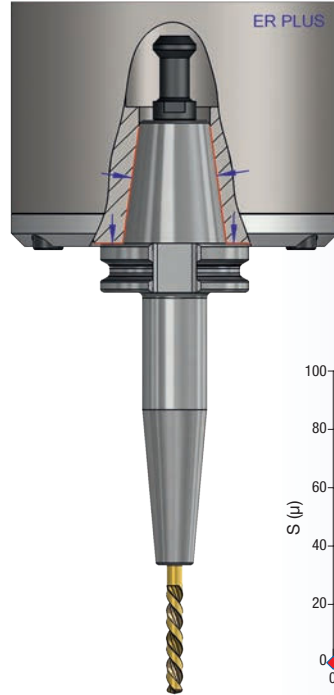
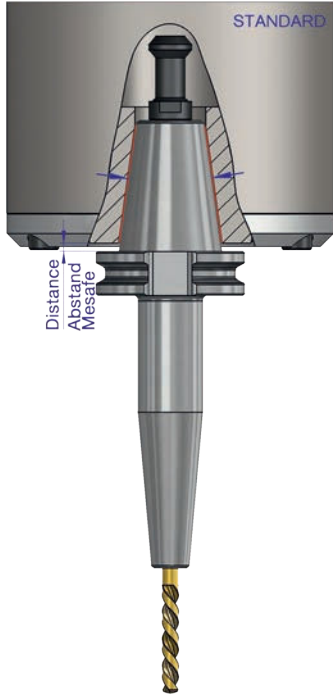

Der Unterschied des ER-PLUS Systems zur konventionellen Schnittstelle, ist eine doppelte Kontaktfläche: am Kegel und gleichzeitig am Werkzeugflansch. Dies erlaubt eine höhere Radialsteifigkeit.

The differences between standard contact face to ER-PLUS system, is a dual contact face: by shank and also flange face. This allows a higher radial rigidity.

La différence du système ER-PLUS d'interface est un contact double: au cône et bride. C'est rendre possible une plus haut rigidité radiale.

Standart takım sistemi ile ER-PLUS takım sistemi arasındaki farklılık, ER-PLUS sisteminde konikte ve alında çift temas yüzeyi sağlamaktır. Bu takımında yüksek radyal rijitlik sağlar.

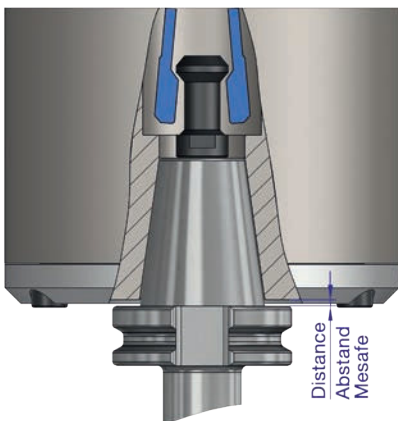

Vor dem Einspannen  
Before clamping  
Avant tendre  
Çektirmeden önce

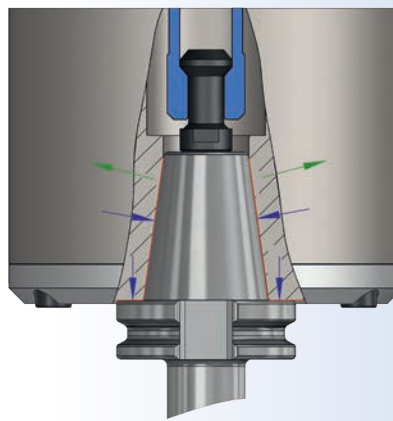

Nach dem Einspannen  
After clamping  
Après tendre  
Çektirmeden sonra

Beispiel Bestellnummer : 403.25.06.80.ERP  
Example order code no : 403.25.06.80.ERP  
Exemple commande no : 403.25.06.80.ERP  
Örnek sipariş numarası : 403.25.06.80.ERP



## Werkzeugaufnahmen

SK DIN 69871 (DIN ISO 7388-1) AD

Toolholders

Porte-outils

Merkezden Soğutmalı  
Konik Şaft Ölçüleri

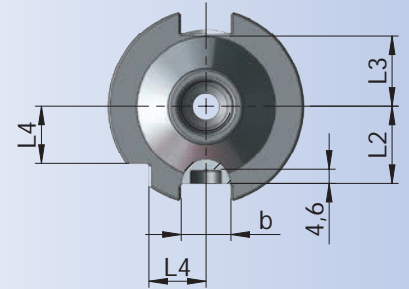
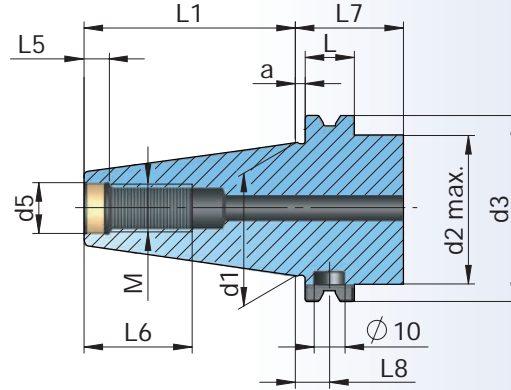

## Werkzeugaufnahmen

SK DIN 69871 (DIN ISO 7388-1) AD/B

Toolholders

Porte-outils

Merkezden ve  
(B) Alından Soğutmalı  
Konik Şaft Ölçüleri

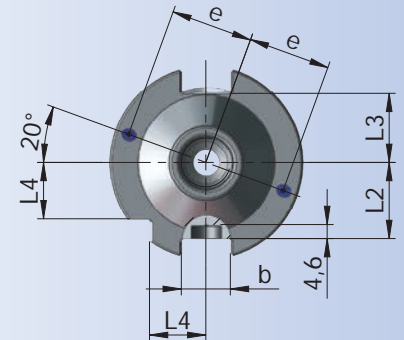
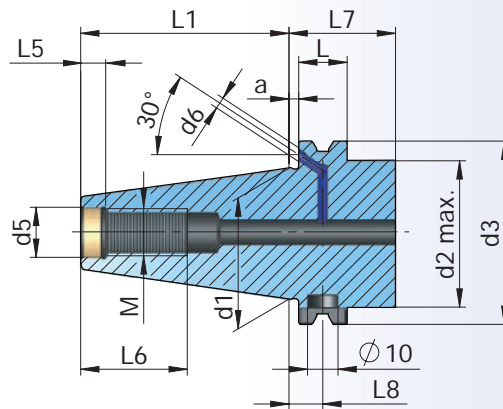

## Werkzeugaufnahmen SK ERPLUS

SK DIN 69871 (DIN ISO 7388-1) AD

Toolholders SK ERPLUS

Porte-outils SK ERPLUS

Merkezden Soğutmalı  
Konik Şaft Ölçüleri

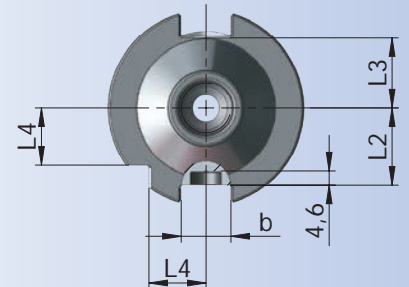
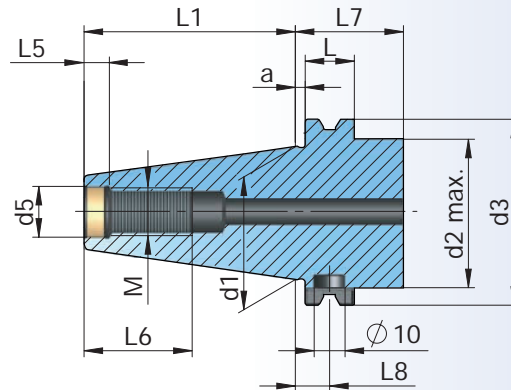

## Werkzeugaufnahmen SK ERPLUS

SK DIN 69871 (DIN ISO 7388-1) AD/B

Toolholders SK ERPLUS

Porte-outils SK ERPLUS

Merkezden ve  
(B) Alından Soğutmalı  
Konik Şaft Ölçüleri

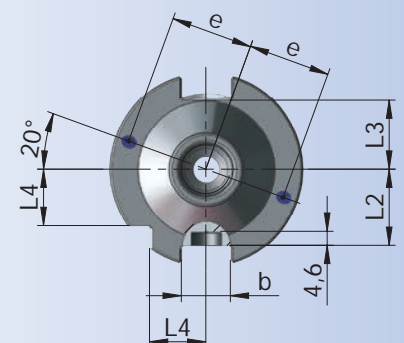
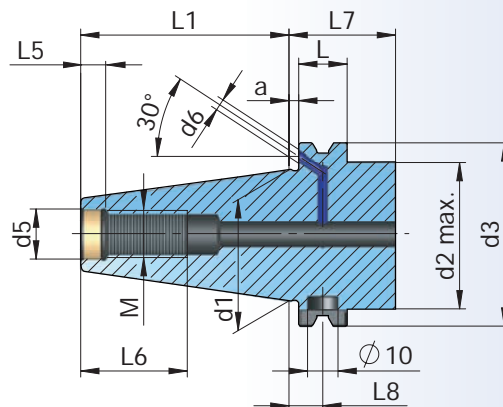



SK	FORM	d1	a	M	L6	d3	L	d2 max.	L7	L1	d5	L5	b	L2	L3	L4	L8	d6	e
SK 30	AD	31,75	3,2	M12	24	50,00	15,9	45	35	47,80	13	5,5	16,1	18,8	16,3	15,0	11,1	-	-
SK 40	AD	44,45	3,2	M16	32	63,55	15,9	50	35	68,40	17	8,2	16,1	25,0	22,7	18,5	11,1	-	-
SK 40	AD/B	44,45	3,2	M16	32	63,55	15,9	50	35	68,40	17	8,2	16,1	25,0	22,7	18,5	11,1	4	27
SK 40-ERP	AD	44,45	1,0	M16	32	63,55	18,1	50	35	68,40	17	8,2	16,1	25,0	22,7	18,5	11,1	-	-
SK 40-ERP	AD/B	44,45	1,0	M16	32	63,55	18,1	50	35	68,40	17	8,2	16,1	25,0	22,7	18,5	11,1	4	27
SK 50	AD	69,85	3,2	M24	47	97,50	15,9	80	35	101,75	25	11,5	25,7	37,7	35,5	30,0	11,1	-	-
SK 50	AD/B	69,85	3,2	M24	47	97,50	15,9	80	35	101,75	25	11,5	25,7	37,7	35,5	30,0	11,1	6	42
SK 50-ERP	AD	69,85	1,5	M24	47	97,50	17,6	80	35	101,75	25	11,5	25,7	37,7	35,5	30,0	11,1	-	-
SK 50-ERP	AD/B	69,85	1,5	M24	47	97,50	17,6	80	35	101,75	25	11,5	25,7	37,7	35,5	30,0	11,1	6	42

**Werkstoff** : Legierter Einsatzstahl mit einer Zugfestigkeit im Kern von min. 950 N/mm<sup>2</sup>

**Ausführung** : Einsatzgehärtet HRC 58 ± 2 Härtetiefe 0,6 mm + 0,2 mm, brüniert

**Genauigkeit** : Kegelwinkel-Toleranzqualität AT 3 nach DIN 2080

Oberflächenrauigkeit des Kegels Ra 0,2

**Chip** : Bohrung für Datenträger DIN 69873 im Bund.

**Material** : Case hardened steel, tensile strength in the core min. 950 N/mm<sup>2</sup>

**Execution** : Case hardened HRC 58 ± 2 Depth of case 0,6 mm + 0,2 mm, black-finish

**Accuracy** : Cone angle AT 3 according DIN 2080

Surface roughness of cone Ra 0,2

**Chip hole** : Bore for data carrier DIN 69873 in collar.

**Matière** : Châssis d'allié en acier de cémentation. Résistance à la traction dans le noyau de min 950 N/mm<sup>2</sup>

**Exécution** : Cémenté HRC 58 ± 2 Epaisseur de cémentation 0,6 mm + 0,2 mm  
Bruni

**Précision** : Qualité de finition pour l'angle des cône AT 3 suivant DIN 2080

Rugosité en surface du cône Ra 0,2

**Puce** : Pergage pour support de données DIN 69873 dans la collerette.

**Malzeme** : Alaşımlı semente çeliği çekme mukavemeti min. 950 N/mm<sup>2</sup>

**Teknik özelliği** : Sertlik HRC 58 ± 2 sertlik derinliği 0,6 mm + 0,2 mm, karartılmış

**Hassasiyeti** : Konik açı tolerans kalitesi DIN 2080 normuna göre AT 3

Konik yüzey kalitesi Ra 0,2

**Çip deliği** : Takım bilgilerini saklamak için flanşta DIN 69873 özel çip deliği.



## Toolholders

## Porte-outils

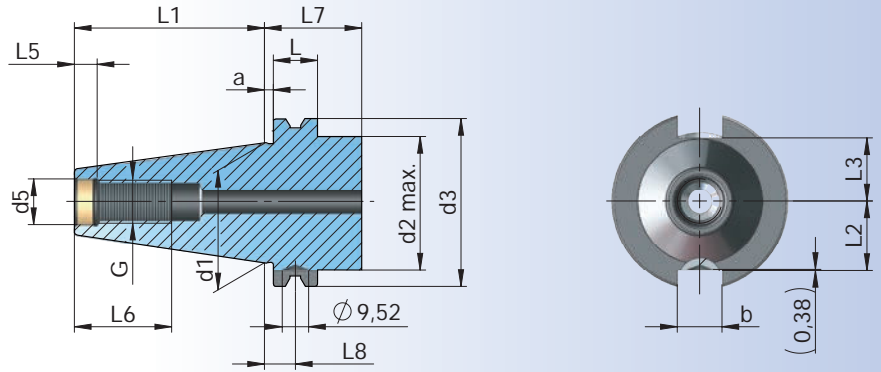
Merkezden Soğutmalı  
Konik Şaft Ölçüleri

## Toolholders

## Porte-outils

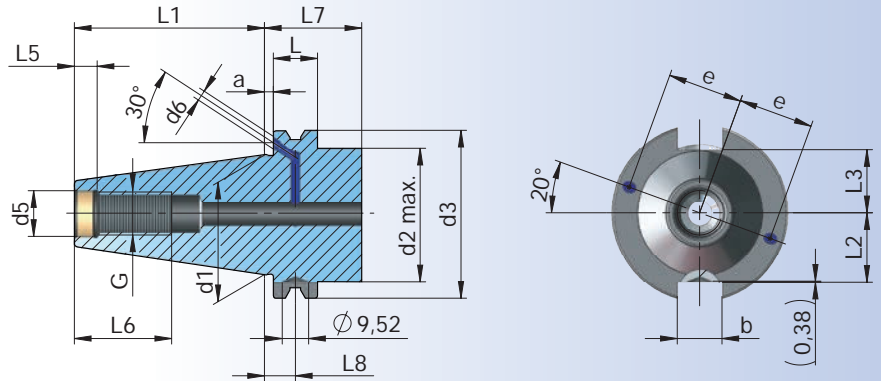
Merkezden ve  
(B) Alından Soğutmalı  
Konik Şaft Ölçüleri

CAT	FORM	d1	a	G	L6	d3	L	d2 max.	L7	L1	d5	L5	b	L2	L3	L8	d6	e
CAT 40	AD	1,75"	0,125"	5/8"x11	1,12"	2,5"	0,625"	1,75"	1,38"	2,687"	0,641"	0,188"	0,645"	0,985"	0,89"	0,438"	-	-
CAT 40	AD/B	1,75"	0,125"	5/8"x11	1,12"	2,5"	0,625"	1,75"	1,38"	2,687"	0,641"	0,188"	0,645"	0,985"	0,89"	0,438"	0,157"	1,062"
CAT 50	AD	2,75"	0,125"	1"x8	1,75"	3,875"	0,625"	2,75"	1,38"	4"	1,031"	0,25"	1,02"	1,485"	1,39"	0,438"	-	-
CAT 50	AD/B	2,75"	0,125"	1"x8	1,75"	3,875"	0,625"	2,75"	1,38"	4"	1,031"	0,25"	1,02"	1,485"	1,39"	0,438"	0,236"	1,654"

**Werkstoff** : Legierter Einsatzstahl mit einer Zugfestigkeit im Kern von min. 950 N/mm<sup>2</sup>  
**Ausführung** : Einsatzgehärtet HRC 58 ± 2 Härtetiefe 0,6 mm + 0,2 mm, brüniert  
**Genauigkeit** : Kegelswinkel-Toleranzqualität AT 3 nach DIN 2080  
Oberflächenrauigkeit des Kegels Ra 0,2

**Material** : Case hardened steel, tensile strength in the core min. 950 N/mm<sup>2</sup>  
**Execution** : Case hardened HRC 58 ± 2 Depth of case 0,6 mm + 0,2 mm, black-finish  
**Accuracy** : Cone angle AT 3 according DIN 2080  
Surface roughness of cone Ra 0,2

**Matière** : Châssis d'allié en acier de cémentation. Résistance à la traction dans le noyau de min 950 N/mm<sup>2</sup>

**Exécution** : Cémenté HRC 58 ± 2 Epaisseur de cémentation 0,6 mm + 0,2 mm Bruni  
**Précision** : Qualité de finition pour l'angle des cônes AT 3 suivant DIN 2080  
Rugosité en surface du cône Ra 0,2

**Malzeme** : Alaşımlı sement çeliği çekme mukavemeti min. 950 N/mm<sup>2</sup>

**Teknik özelliği** : Sertlik HRC 58 ± 2 sertlik derinliği 0,6 mm + 0,2 mm, karartılmış

**Hassasiyeti** : Konik açı tolerans kalitesi DIN 2080 normuna göre AT 3  
Konik yüzey kalitesi Ra 0,2



## Spannfutter OZ

### Collet chucks OZ

### Mandrin à pinces OZ

### Pens başlığı OZ

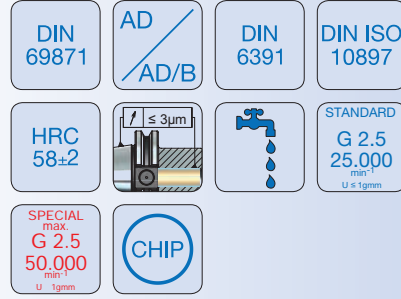

Bestell-Nr. Order Nr. Reference Sipariş Nr.	SK	Form	Abmessung Size Dimension Cinsi	Spannbereich Capacity Capacité Kapasite	A	D	L2	Kg	Euro
302.01.16.60	SK 30	AD	OZ 16	415 E (2 - 16)	60	43	51	0,58	
302.01.25.80	SK 30	AD	OZ 25	462 E (2 - 25)	80	60	61,5	0,97	
402.01.16.70	SK 40	AD	OZ 16	415 E (2 - 16)	70	43	51	1,13	
403.01.16.70	SK 40	AD/B	OZ 16	415 E (2 - 16)	70	43	51	1,13	
402.01.16.100	SK 40	AD	OZ 16	415 E (2 - 16)	100	43	51	1,44	
403.01.16.100	SK 40	AD/B	OZ 16	415 E (2 - 16)	100	43	51	1,44	
402.01.25.70	SK 40	AD	OZ 25	462 E (2 - 25)	70	60	64	1,30	
403.01.25.70	SK 40	AD/B	OZ 25	462 E (2 - 25)	70	60	64	1,30	
402.01.25.100	SK 40	AD	OZ 25	462 E (2 - 25)	100	60	64	1,69	
403.01.25.100	SK 40	AD/B	OZ 25	462 E (2 - 25)	100	60	64	1,69	
402.01.32.90	SK 40	AD	OZ 32	467 E (4 - 32)	90	72	74	1,77	
403.01.32.90	SK 40	AD/B	OZ 32	467 E (4 - 32)	90	72	74	1,77	
502.01.16.70	SK 50	AD	OZ 16	415 E (2 - 16)	70	43	51	2,90	
503.01.16.70	SK 50	AD/B	OZ 16	415 E (2 - 16)	70	43	71	2,90	
502.01.25.70	SK 50	AD	OZ 25	462 E (2 - 25)	70	60	64	3,20	
503.01.25.70	SK 50	AD/B	OZ 25	462 E (2 - 25)	70	60	68	3,20	
502.01.32.80	SK 50	AD	OZ 32	467 E (4 - 32)	80	72	74	3,64	
503.01.32.80	SK 50	AD/B	OZ 32	467 E (4 - 32)	80	72	77	3,64	
502.01.32.100	SK 50	AD	OZ 32	467 E (4 - 32)	100	72	74	4,26	
503.01.32.100	SK 50	AD/B	OZ 32	467 E (4 - 32)	100	72	74	4,26	

FORM AD

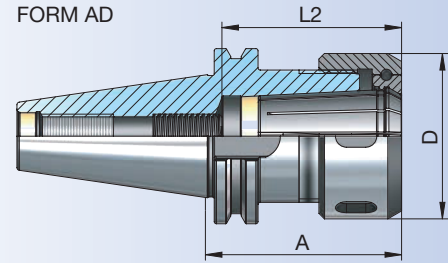

FORM AD/B

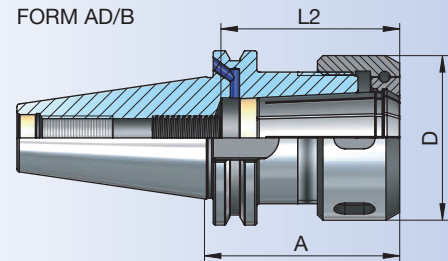

## Zubehör / Accessories / Accessoires / Yedekler

DIN ISO 10897



Spannzangen OZ  
Collets OZ  
Pincés de serrage OZ  
Pens OZ

10.08 - 10.10

DIN ISO 10897



Spannmutter OZ  
Clamping nuts OZ  
Écrou de serrage OZ  
Pens kapağı OZ

10.24 + 10.26

DIN 1810 A



Hakenschlüssel  
Wrench  
Clé à ergot  
E tipi ay anahtar

10.46



## Spannfutter ER

### Collet chucks ER

### Mandrin à pincés ER

### Pens başlığı ER

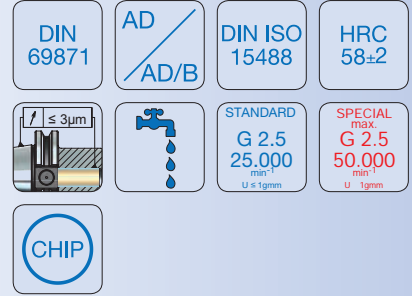

Bestell-Nr. Order Nr. Reference Sipariş Nr.	SK	Form	Spannbereich Capacity Capacité Kapasite	A	D	D1	L1	L2	Kg	Euro
302.02.10.70	SK 30	AD	ER16 (1 - 10)	70	28	-	-	32	0,54	
302.02.10.100	SK 30	AD	ER16 (1 - 10)	100	28	-	-	32	0,67	
302.02.16.70	SK 30	AD	ER25 (2 - 16)	70	42	-	-	42	0,68	
302.02.16.100	SK 30	AD	ER25 (2 - 16)	100	42	-	-	42	0,99	
302.02.20.70	SK 30	AD	ER32 (2 - 20)	70	50	-	-	48	0,67	
302.02.20.100	SK 30	AD	ER32 (2 - 20)	100	50	-	-	48	0,95	
*302.02.20.50.ON	SK 30	AD	ER32 (2 - 20)	50	50	-	-	48	0,52	
*302.02.20.70.ON	SK 30	AD	ER32 (2 - 20)	70	50	-	-	48	0,70	
302.02.26.70	SK 30	AD	ER40 (3 - 26)	70	63	-	-	55	0,82	
402.02.10.63	SK 40	AD	ER16 (1 - 10)	63	28	-	-	32	0,94	
403.02.10.63	SK 40	AD/B	ER16 (1 - 10)	63	28	-	-	32	0,93	
402.02.10.100	SK 40	AD	ER16 (1 - 10)	100	28	-	-	32	1,09	
403.02.10.100	SK 40	AD/B	ER16 (1 - 10)	100	28	-	-	32	1,08	
402.02.10.130	SK 40	AD	ER16 (1 - 10)	130	28	-	-	32	1,20	
403.02.10.130	SK 40	AD/B	ER16 (1 - 10)	130	28	-	-	32	1,20	
402.02.10.160	SK 40	AD	ER16 (1 - 10)	160	28	32	98	32	1,36	
403.02.10.160	SK 40	AD/B	ER16 (1 - 10)	160	28	32	98	32	1,35	
403.02.10.200	SK 40	AD/B	ER16 (1 - 10)	200	28	34	120	32	1,55	
<b>new</b> 403.02.13.70	SK 40	AD/B	ER20 (1 - 13)	70	34	-	-	39,5	1,03	
<b>new</b> 403.02.13.100	SK 40	AD/B	ER20 (1 - 13)	100	34	-	-	39,5	1,21	
<b>new</b> 403.02.13.130	SK 40	AD/B	ER20 (1 - 13)	130	34	-	-	39,5	1,40	
<b>new</b> 403.02.13.160	SK 40	AD/B	ER20 (1 - 13)	160	34	38	99,5	39,5	1,62	
402.02.16.60	SK 40	AD	ER25 (2 - 16)	60	42	-	-	42	1,02	
403.02.16.60	SK 40	AD/B	ER25 (2 - 16)	60	42	-	-	52	1,01	
402.02.16.100	SK 40	AD	ER25 (2 - 16)	100	42	-	-	42	1,42	
403.02.16.100	SK 40	AD/B	ER25 (2 - 16)	100	42	-	-	42	1,41	
402.02.16.130	SK 40	AD	ER25 (2 - 16)	130	42	-	-	42	1,72	
403.02.16.130	SK 40	AD/B	ER25 (2 - 16)	130	42	-	-	42	1,71	
402.02.16.160	SK 40	AD	ER25 (2 - 16)	160	42	46,5	100	42	2,06	
403.02.16.160	SK 40	AD/B	ER25 (2 - 16)	160	42	46,5	100	42	2,05	
403.02.16.200	SK 40	AD/B	ER25 (2 - 16)	200	42	48,5	120	42	2,51	

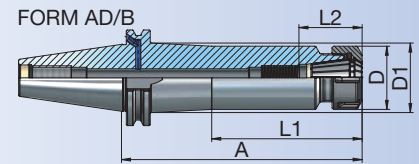
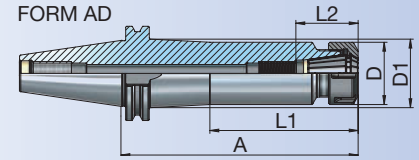

- \* Die Aufnahmen für die Holzbearbeitung werden ohne Mitnehmernuten und ohne Positionierungskerbe hergestellt.
- \* The holders for the woodworking is produced without driving grooves and without positioning mark
- \* L`outils pour le travail du bois sont produits sans rainures de brides et sans marquage de positionnement.
- \* Ağaç işleme tezgahları için kama kanalsız üretilmektedir .

## Zubehör / Accessories / Accessoires / Yedekler







## Spannfutter ER

### Collet chucks ER

### Mandrin à pinces ER

### Pens başlığı ER

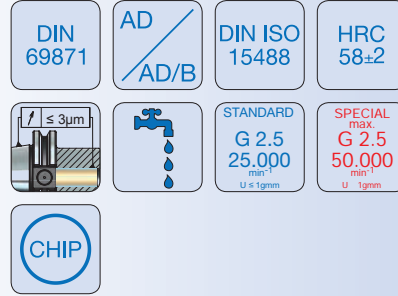

Bestell-Nr. Order Nr. Reference Sipariş Nr.	SK	Form	Spannbereich Capacity Capacité Kapasite	A	D	D1	L1	L2	Kg	Euro
402.02.20.70	SK 40	AD	ER32 (2 - 20)	70	50	-	-	48	1,21	
403.02.20.70	SK 40	AD/B	ER32 (2 - 20)	70	50	-	-	48	1,20	
402.02.20.100	SK 40	AD	ER32 (2 - 20)	100	50	-	-	48	1,64	
403.02.20.100	SK 40	AD/B	ER32 (2 - 20)	100	50	-	-	48	1,63	
402.02.20.130	SK 40	AD	ER32 (2 - 20)	130	50	-	-	48	2,07	
403.02.20.130	SK 40	AD/B	ER32 (2 - 20)	130	50	-	-	48	2,07	
402.02.20.160	SK 40	AD	ER32 (2 - 20)	160	50	-	-	48	2,50	
403.02.20.160	SK 40	AD/B	ER32 (2 - 20)	160	50	-	-	48	2,50	
403.02.20.200	SK 40	AD/B	ER32 (2 - 20)	200	50	-	-	48	3,08	
402.02.26.80	SK 40	AD	ER40 (3 - 26)	80	63	-	-	55	1,43	
403.02.26.80	SK 40	AD/B	ER40 (3 - 26)	80	63	-	-	55	1,43	
402.02.26.100	SK 40	AD	ER40 (3 - 26)	100	63	-	-	55	1,72	
403.02.26.100	SK 40	AD/B	ER40 (3 - 26)	100	63	-	-	55	1,71	
402.02.26.130	SK 40	AD	ER40 (3 - 26)	130	63	-	-	55	2,15	
403.02.26.130	SK 40	AD/B	ER40 (3 - 26)	130	63	-	-	55	2,15	
402.02.26.160	SK 40	AD	ER40 (3 - 26)	160	63	-	-	55	2,58	
403.02.26.160	SK 40	AD/B	ER40 (3 - 26)	160	63	-	-	55	2,58	
403.02.26.200	SK 40	AD/B	ER40 (3 - 26)	200	63	-	-	55	3,16	

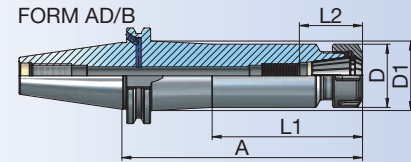
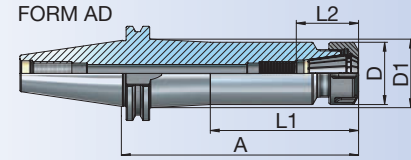

## Zubehör / Accessories / Accessoires / Yedekler



Spannzangen System ER  
Collets System ER  
Pincés de serrage System ER  
Pens ER



Spannmutter ER  
Clamping nuts ER  
Écrou de serrage ER  
Pens kapağı ER



Spannschlüssel für ER  
Wrench ER  
Clé de serrage ER  
Anahtar ER



11.01



## Spannfutter ER

Collet chucks ER

Mandrin à pinces ER

Pens başlığı ER

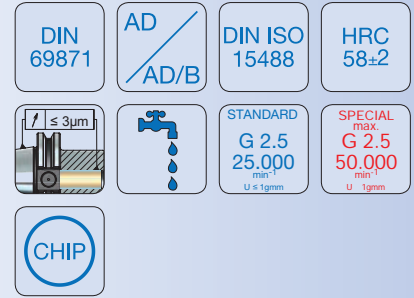

Bestell-Nr. Order Nr. Reference Sipariş Nr.	SK	Form	Spannbereich Capacity Capacité Kapasite	A	D	D1	L1	L2	Kg	Euro
502.02.10.63	SK 50	AD	ER16 (1 - 10)	63	28	-	-	32	2,75	
503.02.10.63	SK 50	AD/B	ER16 (1 - 10)	63	28	-	-	32	2,74	
502.02.10.100	SK 50	AD	ER16 (1 - 10)	100	28	-	-	32	2,90	
503.02.10.100	SK 50	AD/B	ER16 (1 - 10)	100	28	-	-	32	2,88	
502.02.10.130	SK 50	AD	ER16 (1 - 10)	130	28	-	-	32	3,02	
503.02.10.130	SK 50	AD/B	ER16 (1 - 10)	130	28	-	-	32	3,00	
502.02.10.160	SK 50	AD	ER16 (1 - 10)	160	28	32	98	32	3,17	
503.02.10.160	SK 50	AD/B	ER16 (1 - 10)	160	28	32	98	32	3,15	
503.02.10.200	SK 50	AD/B	ER16 (1 - 10)	200	28	33,5	120	32	3,36	
<b>new</b> 503.02.13.70	SK 50	AD/B	ER20 (1 - 13)	70	34	-	-	39,5	2,83	
<b>new</b> 503.02.13.100	SK 50	AD/B	ER20 (1 - 13)	100	34	-	-	39,5	3,02	
<b>new</b> 503.02.13.130	SK 50	AD/B	ER20 (1 - 13)	130	34	-	-	39,5	3,20	
<b>new</b> 503.02.13.160	SK 50	AD/B	ER20 (1 - 13)	160	34	38	99,5	39,5	3,43	
502.02.16.60	SK 50	AD	ER25 (2 - 16)	60	42	-	-	42	2,84	
503.02.16.60	SK 50	AD/B	ER25 (2 - 16)	60	42	-	-	60	2,80	
502.02.16.100	SK 50	AD	ER25 (2 - 16)	100	42	-	-	42	3,23	
503.02.16.100	SK 50	AD/B	ER25 (2 - 16)	100	42	-	-	42	3,22	
502.02.16.130	SK 50	AD	ER25 (2 - 16)	130	42	-	-	42	3,53	
503.02.16.130	SK 50	AD/B	ER25 (2 - 16)	130	42	-	-	42	3,52	
502.02.16.160	SK 50	AD	ER25 (2 - 16)	160	42	46	100	42	3,88	
503.02.16.160	SK 50	AD/B	ER25 (2 - 16)	160	42	46	100	42	3,86	
503.02.16.200	SK 50	AD/B	ER25 (2 - 16)	200	42	47,5	120	42	4,34	

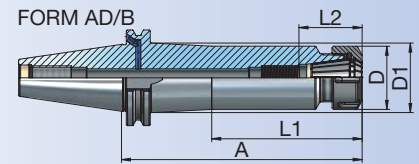
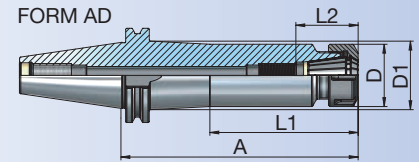

## Zubehör / Accessories / Accessoires / Yedekler

DIN ISO 15488



10.11 - 10.18

Spannzangen System ER  
Collets System ER  
Pinces de serrage System ER  
Pens ER

DIN ISO 15488



10.25 - 10.26

Spannmutter ER  
Clamping nuts ER  
Écrou de serrage ER  
Pens kapağı ER

10.48



Spann Schlüssel für ER  
Wrench ER  
Clé de serrage ER  
Anahtar ER



11.01



## Spannfutter ER

### Collet chucks ER

### Mandrin à pinces ER

### Pens başlığı ER

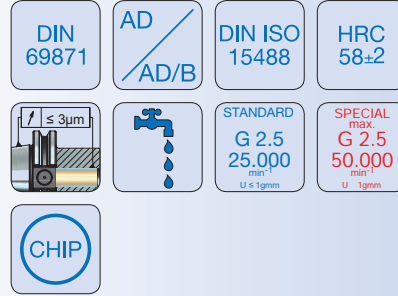

Bestell-Nr. Order Nr. Reference Sipariş Nr.	SK	Form	Spannbereich Capacity Capacité Kapasite	A	D	D1	L1	L2	Kg	Euro
502.02.20.70	SK 50	AD	ER32 (2 - 20)	70	50	-	-	48	3,03	
503.02.20.70	SK 50	AD/B	ER32 (2 - 20)	70	50	-	-	69	2,96	
502.02.20.100	SK 50	AD	ER32 (2 - 20)	100	50	-	-	48	3,46	
503.02.20.100	SK 50	AD/B	ER32 (2 - 20)	100	50	-	-	48	3,44	
502.02.20.130	SK 50	AD	ER32 (2 - 20)	130	50	-	-	48	3,90	
503.02.20.130	SK 50	AD/B	ER32 (2 - 20)	130	50	-	-	48	3,88	
502.02.20.160	SK 50	AD	ER32 (2 - 20)	160	50	54	101	48	4,38	
503.02.20.160	SK 50	AD/B	ER32 (2 - 20)	160	50	54	101	48	4,37	
503.02.20.200	SK 50	AD/B	ER32 (2 - 20)	200	50	55,5	120	48	5,04	
502.02.26.80	SK 50	AD	ER40 (3 - 26)	80	63	-	-	55	3,47	
503.02.26.80	SK 50	AD/B	ER40 (3 - 26)	80	63	-	-	55	3,46	
502.02.26.100	SK 50	AD	ER40 (3 - 26)	100	63	-	-	55	3,94	
503.02.26.100	SK 50	AD/B	ER40 (3 - 26)	100	63	-	-	55	3,93	
502.02.26.130	SK 50	AD	ER40 (3 - 26)	130	63	-	-	55	4,65	
503.02.26.130	SK 50	AD/B	ER40 (3 - 26)	130	63	-	-	55	4,63	
502.02.26.160	SK 50	AD	ER40 (3 - 26)	160	63	66,5	103	55	5,41	
503.02.26.160	SK 50	AD/B	ER40 (3 - 26)	160	63	66,5	103	55	5,40	
503.02.26.200	SK 50	AD/B	ER40 (3 - 26)	200	63	69	120	55	6,43	

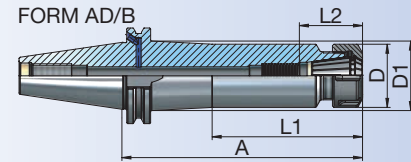
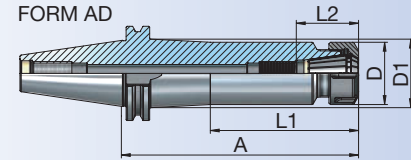

## Zubehör / Accessories / Accessoires / Yedekler



Spannzangen System ER  
Collets System ER  
Pincés de serrage System ER  
Pens ER



Spannmutter ER  
Clamping nuts ER  
Écrou de serrage ER  
Pens kapağı ER



Spannschlüssel für ER  
Wrench ER  
Clé de serrage ER  
Anahtar ER



11.01



## Spannfutter ER Mini

Collet chucks ER Mini

Mandrin à pincés ER Mini

Pens başlığı ER Mini

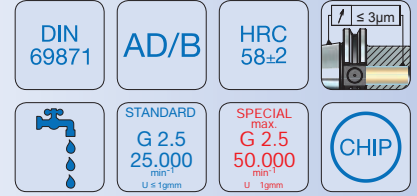

Bestell-Nr. Order Nr. Reference Sipariş Nr.	SK	Form	Spannbereich Capacity Capacité Kapasite	A	D	D1	L1	L2	Kg	Euro
403.02.07.55.M	SK 40	AD/B	ER11 (1 - 7)	55	16	-	-	46,5	0,85	
403.02.07.100.M	SK 40	AD/B	ER11 (1 - 7)	100	16	-	-	41,5	0,91	
403.02.07.130.M	SK 40	AD/B	ER11 (1 - 7)	130	16	-	-	41,5	0,95	
403.02.07.160.M	SK 40	AD/B	ER11 (1 - 7)	160	16	20	94,5	41,5	1,02	
403.02.10.100.M	SK 40	AD/B	ER16 (1 - 10)	100	22	-	-	32	0,98	
403.02.10.130.M	SK 40	AD/B	ER16 (1 - 10)	130	22	-	-	32	1,06	
403.02.10.160.M	SK 40	AD/B	ER16 (1 - 10)	160	22	26	98	32	1,16	
503.02.10.100.M	SK 50	AD/B	ER16 (1 - 10)	100	22	-	-	32	2,79	
503.02.10.130.M	SK 50	AD/B	ER16 (1 - 10)	130	22	-	-	32	2,87	
503.02.10.160.M	SK 50	AD/B	ER16 (1 - 10)	160	22	26	98	32	2,97	

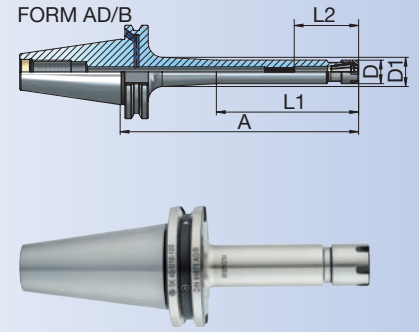

## Zubehör / Accessories / Accessoires / Yedekler



Spannzangen System ER  
Collets System ER  
Pincés de serrage System ER  
Pens ER



Spannmutter Mini  
Nut Mini  
Écrou mini  
Mini kapak



Rollenschlüssel für Spannmutter  
Roller Bearing Wrenches  
Cles à rouleaux  
Bilyalı Kapak Sıkma Anahtar



Spannschlüssel  
Wrench  
Clé de serrage  
Anahtar ER



11.01



## Spannfuttersatz im Koffer

### Collet chuck set in box

### Mandrin á pincas pour pincas (set) dans coffre

### Pens başlığı seti plastik kutuda

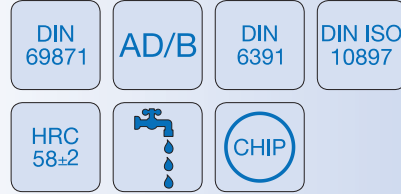

Bestell-Nr. Order Nr. Reference Sipariş Nr.	SK	Form	Abmessung Size Dimension Cinsi	Spannbereich Capacity Capacité Kapasite	Spannzangen Durchmesser Collet Diameter Pincas Diamètre Pens Çapı	Spannzangen Stk. Collet Pcs. Pincas Pens Adedi	Kg	Euro
<b>new</b> 403.61.16.70	SK 40	AD/B	OZ 16	415 E (2 - 16)	4-5-6-7-8-9-10-11-12-14-15-16	12	2,74	
<b>new</b> 403.61.25.70	SK 40	AD/B	OZ 25	462 E (2 - 25)	4-5-6-7-8-9-10-11-12-14-16-18-20-22-24-25	16	5,57	
<b>new</b> 403.61.32.90	SK 40	AD/B	OZ 32	467 E (4 - 32)	6-7-8-9-10-12-14-16-18-20-22-24-25-28-30-32	16	8,94	
<b>new</b> 503.61.25.70	SK 50	AD/B	OZ 25	462 E (2 - 25)	4-5-6-7-8-9-10-11-12-14-16-18-20-22-24-25	16	7,72	
<b>new</b> 503.61.32.80	SK 50	AD/B	OZ 32	467 E (4 - 32)	6-7-8-9-10-12-14-16-18-20-22-24-25-28-30-32	16	10,81	

Lieferumfang : Spannfutter, inkl. Spannzangen mit Schlüssel  
Included : Collet chuck with collets and wrench  
Inclus : Mandrin avec pincas et clé  
Teslim Şekli : Tutucu, pensleri ve anahtarıyla birlikte

### Zubehör / Accessories / Accessoires / Yedekler

 DIN ISO 10897 10.08 - 10.10	Spannzangen OZ Collets OZ Pincas de serrage OZ Pens OZ	 DIN ISO 10897 10.24 + 10.26	Spannmutter OZ Clamping nuts OZ Écrou de serrage OZ Pens kapağı OZ	 DIN 1810 A 10.46	Hakenschlüssel Wrench Clé à ergot E tipi ay anahtar
--	---	--	---	---	--



## Spannfuttersatz im Koffer

### Collet chuck set in box

### Mandrin á pincas pour pincas (set) dans coffre

### Pens başlığı seti plastik kutuda

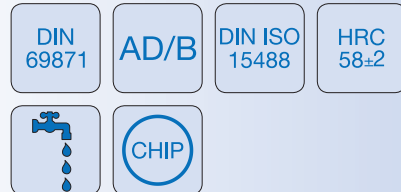

Bestell-Nr. Order Nr. Reference Sipariş Nr.	SK	Form	Spannbereich Capacity Capacité Kapasite	Spannzangen Durchmesser Collet Diameter Pincas Diamètre Pens Çapı	Spannzangen Stk. Collet Pcs. Pincas Pens Adedi	Kg	Euro
<b>new</b> 403.62.16.60	SK 40	AD/B	ER25 (2 - 16)	3-4-5-6-7-8-9-10-11-12-14-16	12	2,53	
<b>new</b> 403.62.20.70	SK 40	AD/B	ER32 (2 - 20)	4-5-6-7-8-9-10-11-12-13-14-15-16-18-20	15	4,45	
<b>new</b> 403.62.26.80	SK 40	AD/B	ER40 (3 - 26)	4-5-6-7-8-9-10-12-14-16-18-20-22-24-25-26	16	6,73	
<b>new</b> 503.62.20.70	SK 50	AD/B	ER32 (2 - 20)	4-5-6-7-8-9-10-11-12-13-14-15-16-18-20	15	7,37	
<b>new</b> 503.62.26.80	SK 50	AD/B	ER40 (3 - 26)	4-5-6-7-8-9-10-12-14-16-18-20-22-24-25-26	16	9,02	

Lieferumfang : Spannfutter, inkl. Spannzangen mit Schlüssel  
Included : Collet chuck with collets and wrench  
Inclus : Mandrin avec pincas et clé  
Teslim Şekli : Tutucu, pensleri ve anahtarıyla birlikte

### Zubehör / Accessories / Accessoires / Yedekler

 DIN ISO 15488 10.11 - 10.18	Spannzangen System ER Collets System ER Pincas de serrage System ER Pens ER	 DIN ISO 15488 10.25 - 10.26	Spannmutter ER Clamping nuts ER Écrou de serrage ER Pens kapağı ER	 10.48	Spannschlüssel für ER Wrench ER Clé de serrage ER Anahtar ER
---	--	---	---	--	---





## Ausrichtbares Werkzeugspannfutter, radial und axial einstellbar

Adjustable toolholder, adjustable radial and axial

Mandrin à tige de réglage, réglage radial et axial

Hassas ayarlanabilir pens tutucular, eksenel ve radyal yönde

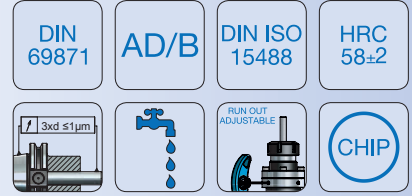

### Micro-mec ARF-Plus Ausrichtfutter

Bestell-Nr. Order Nr. Reference Sipariş Nr.	SK	Form	Spannbereich Capacity Capacité Kapasite	D	A	L1	L2	D1	M	M1	Kg	Euro
403.02.20.109.ARF-P	SK 40	AD/B	ER32 (2 - 20)	50	109	47	48	68	M6	M6	2,21	
503.02.20.109.ARF-P	SK 50	AD/B	ER32 (2 - 20)	50	109	47	48	68	M6	M6	4,04	

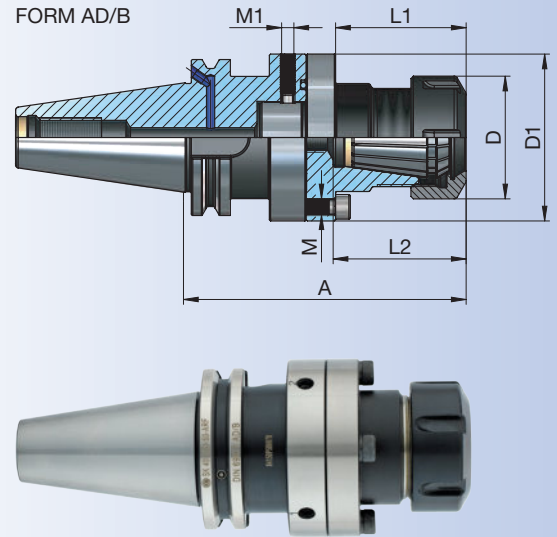

### Zubehör / Accessories / Accessoires / Yedekler



DIN ISO 15488  
Spannzangen System ER  
Collets System ER  
Pincos de serrage System ER  
Pens ER  
10.11 - 10.18



DIN ISO 15488  
Spannmutter ER  
Clamping nuts ER  
Écrou de serrage ER  
Pens kapağı ER  
10.25 - 10.26



DIN 912  
Anzugschraube  
Bolt  
Trette  
Civata  
10.39



DIN 915  
Einstellschraube  
Adjusting screw  
Vis de réglage  
Ayar civatası  
10.39



Spannschlüssel für ER  
Wrench ER  
Clé de serrage ER  
Anahtar ER  
10.48



11.04



## Präzisionskraftspannfutter

### Precision milling chuck

### Mandrin de fraisage de précision

### Bilyalı pens tutucu

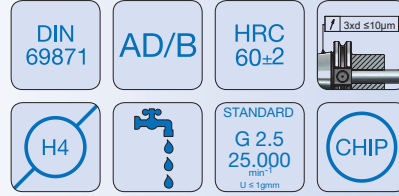

Bestell-Nr. Order Nr. Reference Sipariş Nr.	SK	Form	Spannbereich Capacity Capacité Kapasite	d	A	D	L2	Kg	Euro
<b>new</b> 403.03.20.90.N	SK 40	AD/B	EKS 20 (6-20)	20	90	48	80	1,53	
<b>new</b> 403.03.20.130.N	SK 40	AD/B	EKS 20 (6-20)	20	130	48	80	2,06	
<b>new</b> 403.03.20.160.N	SK 40	AD/B	EKS 20 (6-20)	20	160	48	80	2,45	
<b>new</b> 403.03.20.200.N	SK 40	AD/B	EKS 20 (6-20)	20	200	48	80	2,97	
<b>new</b> 403.03.25.90.N	SK 40	AD/B	EKS 25 (6-25)	25	90	55	80	2,60	
<b>new</b> 403.03.32.100.N	SK 40	AD/B	EKS 32 (6-32)	32	100	68	80	2,28	
<b>new</b> 403.03.32.130.N	SK 40	AD/B	EKS 32 (6-32)	32	130	68	80	2,81	
<b>new</b> 403.03.32.160.N	SK 40	AD/B	EKS 32 (6-32)	32	160	68	80	3,48	
<b>new</b> 403.03.32.200.N	SK 40	AD/B	EKS 32 (6-32)	32	200	68	80	4,41	
<b>new</b> 503.03.20.70.N	SK 50	AD/B	EKS 20 (6-20)	20	70	48	80	3,19	
<b>new</b> 503.03.20.130.N	SK 50	AD/B	EKS 20 (6-20)	20	130	48	80	3,85	
<b>new</b> 503.03.20.160.N	SK 50	AD/B	EKS 20 (6-20)	20	160	48	80	4,29	
<b>new</b> 503.03.20.200.N	SK 50	AD/B	EKS 20 (6-20)	20	200	48	80	4,85	
<b>new</b> 503.03.32.95.N	SK 50	AD/B	EKS 32 (6-32)	32	95	68	80	3,95	
<b>new</b> 503.03.32.130.N	SK 50	AD/B	EKS 32 (6-32)	32	130	68	80	4,81	
<b>new</b> 503.03.32.160.N	SK 50	AD/B	EKS 32 (6-32)	32	160	68	80	5,50	
<b>new</b> 503.03.32.200.N	SK 50	AD/B	EKS 32 (6-32)	32	200	68	80	6,36	

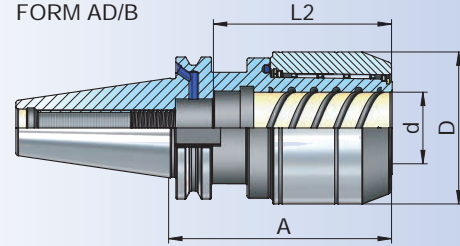

### Zubehör / Accessories / Accessoires / Yedekler



Spannzangen  
Collets  
Pincés de serrage  
Pens



Rollenschlüssel für Spannmutter  
Roller Bearing Wrenches  
Cles à rouleaux  
Bilyalı Kapak Sıkma Anahtar



11.02

## Präzisionskraftspannfuttersatz im Koffer

### Precision milling chuck set in box

### Mandrin de fraisage de précision dans le box

### Bilyalı pens tutucu seti plastik kutuda

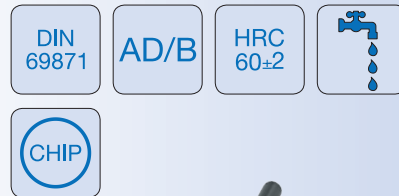

Bestell-Nr. Order Nr. Reference Sipariş Nr.	SK	Form	Spannbereich Capacity Capacité Kapasite	Spannzangen Durchmesser Collet Diameter Pincés Diamètre Pens Çapı	Spannzangen Stk. Collet Pcs. Pincés Pens Adedi	Kg	Euro
<b>new</b> 403.63.20.90.N	SK 40	AD/B	EKS 20 (6-20)	6-8-10-12-16	5	3,26	
<b>new</b> 403.63.32.100.N	SK 40	AD/B	EKS 32 (6-32)	6-8-10-12-16-20-25	7	5,82	
<b>new</b> 503.63.20.70.N	SK 50	AD/B	EKS 20 (6-20)	6-8-10-12-16	5	6,56	
<b>new</b> 503.63.32.95.N	SK 50	AD/B	EKS 32 (6-32)	6-8-10-12-16-20-25	7	8,53	



### Zubehör / Accessories / Accessoires / Yedekler



Spannzangen  
Collets  
Pincés de serrage  
Pens



Rollenschlüssel für Spannmutter  
Roller Bearing Wrenches  
Cles à rouleaux  
Bilyalı Kapak Sıkma Anahtar



11.02

Lieferumfang : Spannfutter, inkl. Spannzangen mit Schlüssel  
Included : Collet chuck with collets and wrench  
Inclus : Mandrin avec pincés et clé  
Teslim Şekli : Tutucu, pensleri ve anahtarlarıyla birlikte



## Fräseraufnahmen

End mill holder

Porte-fraises

Veldon tutucu

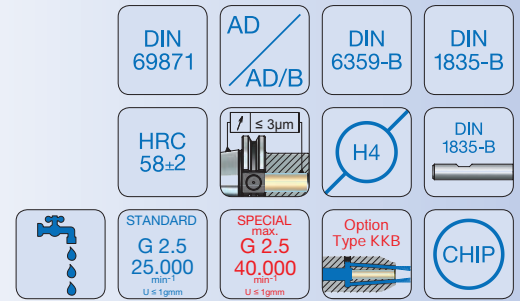

Bestell-Nr. Order Nr. Reference Sipariş Nr.	SK	Form	d	A	D	D1	L1	L2	Kg	Euro
302.04.06.50	SK 30	AD	6	50	25	-	-	36	0,46	
302.04.08.50	SK 30	AD	8	50	28	-	-	40	0,49	
302.04.10.50	SK 30	AD	10	50	35	-	-	44	0,55	
302.04.12.50	SK 30	AD	12	50	42	-	-	51	0,62	
302.04.14.63	SK 30	AD	14	63	44	-	-	51	0,78	
302.04.16.63	SK 30	AD	16	63	48	-	-	54	0,82	
302.04.18.63	SK 30	AD	18	63	50	-	-	54	0,83	
302.04.20.70	SK 30	AD	20	70	52	-	-	56	0,91	
402.04.06.50	SK 40	AD	6	50	25	-	-	36	0,91	
403.04.06.50	SK 40	AD/B	6	50	25	-	-	36	0,90	
402.04.06.100	SK 40	AD	6	100	25	-	-	36	1,08	
403.04.06.100	SK 40	AD/B	6	100	25	-	-	36	1,07	
402.04.06.130	SK 40	AD	6	130	25	-	-	36	1,18	
403.04.06.130	SK 40	AD/B	6	130	25	-	-	36	1,18	
402.04.06.160	SK 40	AD	6	160	25	30,5	88	36	1,33	
403.04.06.160	SK 40	AD/B	6	160	25	30,5	88	36	1,33	
403.04.06.200	SK 40	AD/B	6	200	25	31	120	36	1,48	
402.04.08.50	SK 40	AD	8	50	28	-	-	40	0,93	
403.04.08.50	SK 40	AD/B	8	50	28	-	-	40	0,93	
402.04.08.100	SK 40	AD	8	100	28	-	-	40	1,15	
403.04.08.100	SK 40	AD/B	8	100	28	-	-	40	1,15	
402.04.08.130	SK 40	AD	8	130	28	-	-	40	1,29	
403.04.08.130	SK 40	AD/B	8	130	28	-	-	40	1,28	
402.04.08.160	SK 40	AD	8	160	28	33,5	88	40	1,47	
403.04.08.160	SK 40	AD/B	8	160	28	33,5	88	40	1,47	
403.04.08.200	SK 40	AD/B	8	200	28	34	120	40	1,66	

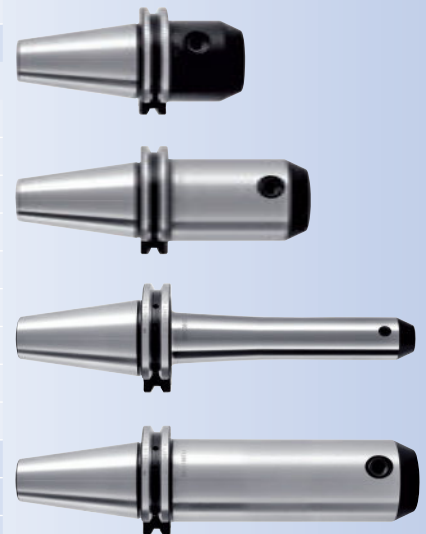
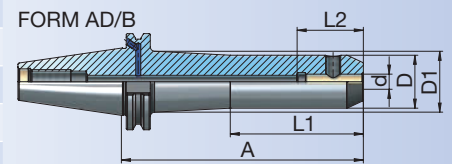
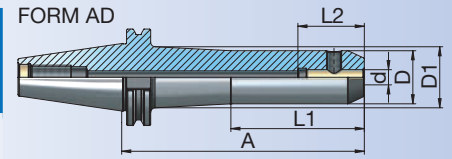

## Zubehör / Accessories / Accessoires / Yedekler



Spannschrauben  
Clamping screw  
Vis de serrage  
Sıkma civatası



i

11.05





## Fräseraufnahmen

End mill holder

Porte-fraises

Veldon tutucu

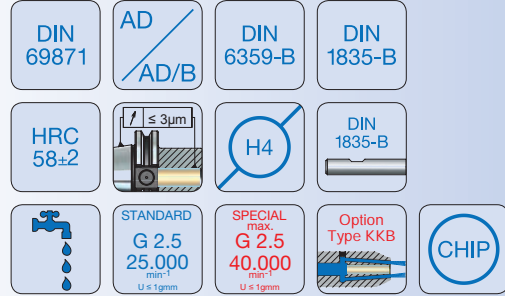

Bestell-Nr. Order Nr. Reference Sipariş Nr.	SK	Form	d	A	D	D1	L1	L2	Kg	Euro
402.04.10.50	SK 40	AD	10	50	35	-	-	44	0,98	
403.04.10.50	SK 40	AD/B	10	50	35	-	-	44	0,98	
402.04.10.100	SK 40	AD	10	100	35	-	-	44	1,31	
403.04.10.100	SK 40	AD/B	10	100	35	-	-	44	1,31	
402.04.10.130	SK 40	AD	10	130	35	-	-	44	1,52	
403.04.10.130	SK 40	AD/B	10	130	35	-	-	44	1,51	
402.04.10.160	SK 40	AD	10	160	35	40,5	88	44	1,78	
403.04.10.160	SK 40	AD/B	10	160	35	40,5	88	44	1,78	
403.04.10.200	SK 40	AD/B	10	200	35	41	120	44	2,06	
402.04.12.50	SK 40	AD	12	50	42	-	-	51	1,05	
403.04.12.50	SK 40	AD/B	12	50	42	-	-	51	1,05	
402.04.12.100	SK 40	AD	12	100	42	-	-	51	1,55	
403.04.12.100	SK 40	AD/B	12	100	42	-	-	51	1,55	
402.04.12.130	SK 40	AD	12	130	42	-	-	51	1,85	
403.04.12.130	SK 40	AD/B	12	130	42	-	-	51	1,85	
402.04.12.160	SK 40	AD	12	160	42	47,5	88	51	2,22	
403.04.12.160	SK 40	AD/B	12	160	42	47,5	88	51	2,22	
403.04.12.200	SK 40	AD/B	12	200	42	48,5	120	51	2,64	
402.04.14.50	SK 40	AD	14	50	44	-	-	51	1,07	
403.04.14.50	SK 40	AD/B	14	50	44	-	-	51	1,06	
402.04.14.100	SK 40	AD	14	100	44	-	-	51	1,62	
403.04.14.100	SK 40	AD/B	14	100	44	-	-	51	1,61	
402.04.14.130	SK 40	AD	14	130	44	-	-	51	1,95	
403.04.14.130	SK 40	AD/B	14	130	44	-	-	51	1,94	
402.04.14.160	SK 40	AD	14	160	44	-	-	51	2,28	
403.04.14.160	SK 40	AD/B	14	160	44	-	-	51	2,27	
403.04.14.200	SK 40	AD/B	14	200	44	-	-	51	2,71	

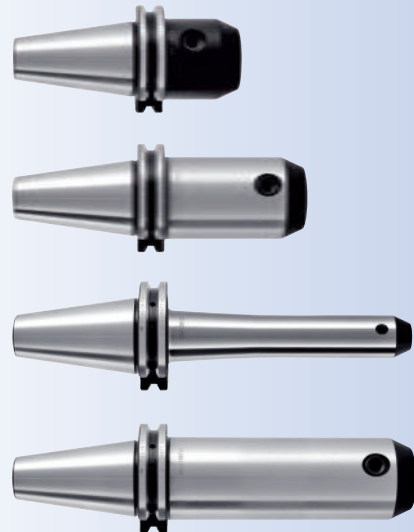
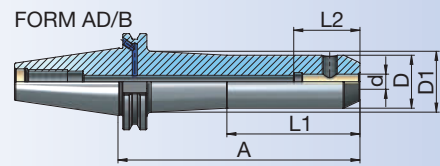
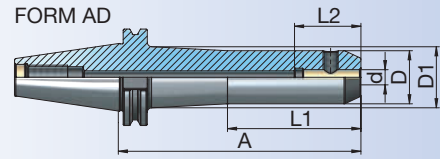

## Zubehör / Accessories / Accessoires / Yedekler

DIN 1835 B



10.38

Spannschrauben  
Clamping screw  
Vis de serrage  
Sıkma civatası



11.05



## Fräseraufnahmen

End mill holder

Porte-fraises

Veldon tutucu

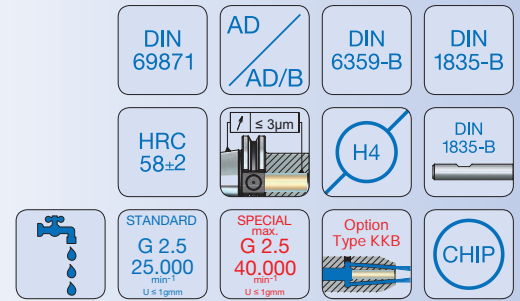

Bestell-Nr. Order Nr. Reference Sipariş Nr.	SK	Form	d	A	D	D1	L1	L2	Kg	Euro
402.04.16.35	SK 40	AD	16	35	45	-	-	54	0,88	
402.04.16.63	SK 40	AD	16	63	48	-	-	54	1,28	
403.04.16.63	SK 40	AD/B	16	63	48	-	-	54	1,28	
402.04.16.100	SK 40	AD	16	100	48	-	-	54	1,77	
403.04.16.100	SK 40	AD/B	16	100	48	-	-	54	1,77	
402.04.16.130	SK 40	AD	16	130	48	-	-	54	2,17	
403.04.16.130	SK 40	AD/B	16	130	48	-	-	54	2,16	
402.04.16.160	SK 40	AD	16	160	48	-	-	54	2,56	
403.04.16.160	SK 40	AD/B	16	160	48	-	-	54	2,56	
403.04.16.200	SK 40	AD/B	16	200	48	-	-	54	3,09	
402.04.18.63	SK 40	AD	18	63	50	-	-	54	1,31	
403.04.18.63	SK 40	AD/B	18	63	50	-	-	54	1,29	
402.04.18.100	SK 40	AD	18	100	50	-	-	54	1,84	
403.04.18.100	SK 40	AD/B	18	100	50	-	-	54	1,83	
402.04.18.130	SK 40	AD	18	130	50	-	-	54	2,27	
403.04.18.130	SK 40	AD/B	18	130	50	-	-	54	2,27	
402.04.18.160	SK 40	AD	18	160	50	-	-	54	2,71	
403.04.18.160	SK 40	AD/B	18	160	50	-	-	54	2,70	
403.04.18.200	SK 40	AD/B	18	200	50	-	-	54	3,28	
402.04.20.35	SK 40	AD	20	35	50	-	-	56	0,85	
402.04.20.63	SK 40	AD	20	63	52	-	-	56	1,31	
403.04.20.63	SK 40	AD/B	20	63	52	-	-	56	1,30	
402.04.20.100	SK 40	AD	20	100	52	-	-	56	1,88	
403.04.20.100	SK 40	AD/B	20	100	52	-	-	56	1,88	
402.04.20.130	SK 40	AD	20	130	52	-	-	56	2,35	
403.04.20.130	SK 40	AD/B	20	130	52	-	-	56	2,35	
402.04.20.160	SK 40	AD	20	160	52	-	-	56	2,82	
403.04.20.160	SK 40	AD/B	20	160	52	-	-	56	2,82	
403.04.20.200	SK 40	AD/B	20	200	52	-	-	56	3,45	

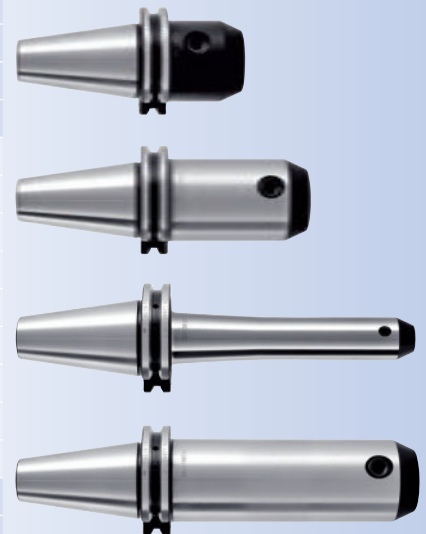
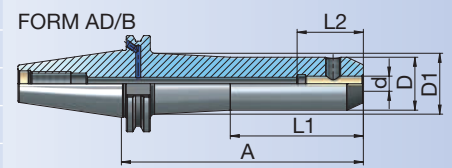
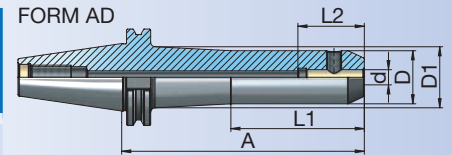

## Zubehör / Accessories / Accessoires / Yedekler



Spannschrauben  
Clamping screw  
Vis de serrage  
Sıkma civatası





## Fräseraufnahmen

End mill holder

Porte-fraises

Veldon tutucu

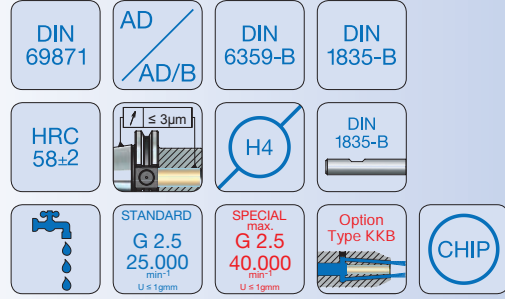

Bestell-Nr. Order Nr. Reference Sipariş Nr.	SK	Form	d	A	D	D1	L1	L2	Kg	Euro
402.04.25.35	SK 40	AD	25	35	50	-	-	64	0,77	
402.04.25.100	SK 40	AD	25	100	63	-	-	64	2,25	
403.04.25.100	SK 40	AD/B	25	100	63	-	-	64	2,25	
402.04.25.130	SK 40	AD	25	130	63	-	-	64	2,95	
403.04.25.130	SK 40	AD/B	25	130	63	-	-	64	2,95	
402.04.25.160	SK 40	AD	25	160	63	-	-	64	3,66	
403.04.25.160	SK 40	AD/B	25	160	63	-	-	64	3,65	
403.04.25.200	SK 40	AD/B	25	200	63	-	-	64	4,59	
402.04.32.65	SK 40	AD	32	65	50	-	-	68	1,09	
402.04.32.100	SK 40	AD	32	100	72	-	-	68	2,55	
403.04.32.100	SK 40	AD/B	32	100	72	-	-	68	2,54	
402.04.32.130	SK 40	AD	32	130	72	-	-	68	3,47	
403.04.32.130	SK 40	AD/B	32	130	72	-	-	68	3,47	
402.04.32.160	SK 40	AD	32	160	72	-	-	68	4,40	
403.04.32.160	SK 40	AD/B	32	160	72	-	-	68	4,39	
402.04.40.120	SK 40	AD	40	120	80	-	-	78	3,42	
403.04.40.120	SK 40	AD/B	40	120	80	-	-	78	3,42	

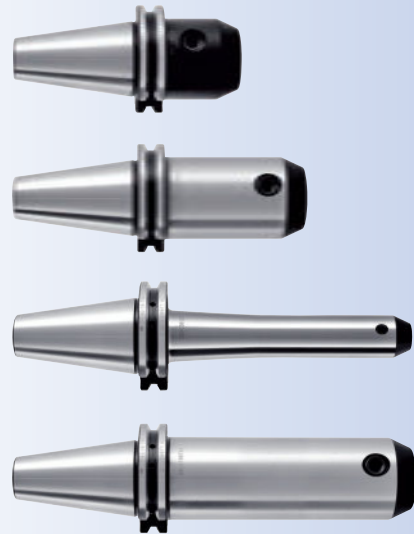
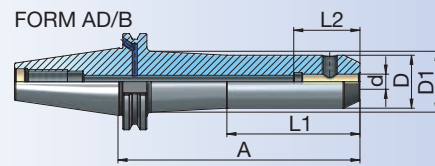
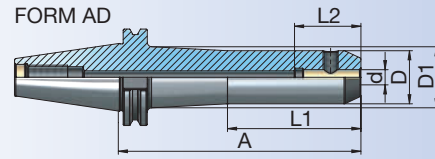

## Zubehör / Accessories / Accessoires / Yedekler

DIN 1835 B



10.38

Spannschrauben  
Clamping screw  
Vis de serrage  
Sıkma civatası



10.05



## Fräseraufnahmen

End mill holder

Porte-fraises

Veldon tutucu

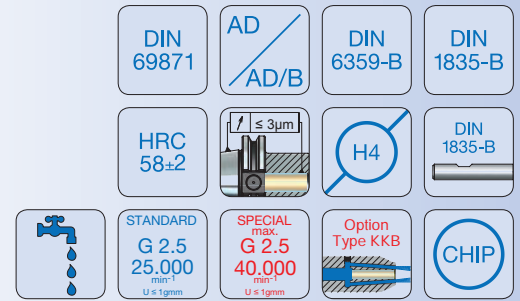

Bestell-Nr. Order Nr. Reference Sipariş Nr.	SK	Form	d	A	D	D1	L1	L2	Kg	Euro
502.04.06.63	SK 50	AD	6	63	25	-	-	36	2,77	
503.04.06.63	SK 50	AD/B	6	63	25	-	-	36	2,75	
502.04.06.100	SK 50	AD	6	100	25	-	-	36	2,89	
503.04.06.100	SK 50	AD/B	6	100	25	-	-	36	2,88	
502.04.06.130	SK 50	AD	6	130	25	-	-	36	3,00	
503.04.06.130	SK 50	AD/B	6	130	25	-	-	36	2,98	
502.04.06.160	SK 50	AD	6	160	25	30,5	88	36	3,15	
503.04.06.160	SK 50	AD/B	6	160	25	30,5	88	36	3,13	
503.04.06.200	SK 50	AD/B	6	200	25	30,5	120	36	3,30	
502.04.08.63	SK 50	AD	8	63	28	-	-	40	2,81	
503.04.08.63	SK 50	AD/B	8	63	28	-	-	40	2,79	
502.04.08.100	SK 50	AD	8	100	28	-	-	40	2,97	
503.04.08.100	SK 50	AD/B	8	100	28	-	-	40	2,96	
502.04.08.130	SK 50	AD	8	130	28	-	-	40	3,10	
503.04.08.130	SK 50	AD/B	8	130	28	-	-	40	3,09	
502.04.08.160	SK 50	AD	8	160	28	33,5	88	40	3,29	
503.04.08.160	SK 50	AD/B	8	160	28	33,5	88	40	3,27	
503.04.08.200	SK 50	AD/B	8	200	28	33,5	120	40	3,48	
502.04.10.63	SK 50	AD	10	63	35	-	-	44	2,88	
503.04.10.63	SK 50	AD/B	10	63	35	-	-	44	2,87	
502.04.10.100	SK 50	AD	10	100	35	-	-	44	3,13	
503.04.10.100	SK 50	AD/B	10	100	35	-	-	44	3,11	
502.04.10.130	SK 50	AD	10	130	35	-	-	44	3,33	
503.04.10.130	SK 50	AD/B	10	130	35	-	-	44	3,31	
502.04.10.160	SK 50	AD	10	160	35	40,5	88	44	3,59	
503.04.10.160	SK 50	AD/B	10	160	35	40,5	88	44	3,58	
503.04.10.200	SK 50	AD/B	10	200	35	40,5	120	44	3,88	

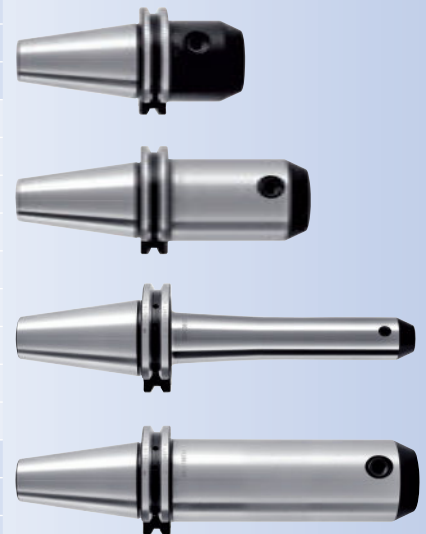
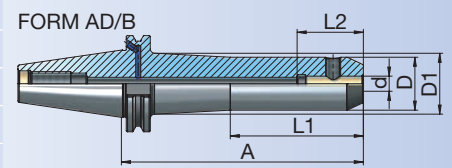
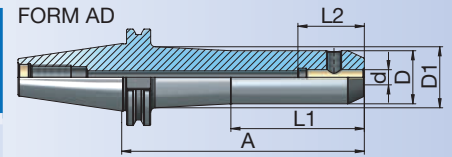

## Zubehör / Accessories / Accessoires / Yedekler



Spannschrauben  
Clamping screw  
Vis de serrage  
Sıkma civatası





## Fräseraufnahmen

End mill holder

Porte-fraises

Veldon tutucu

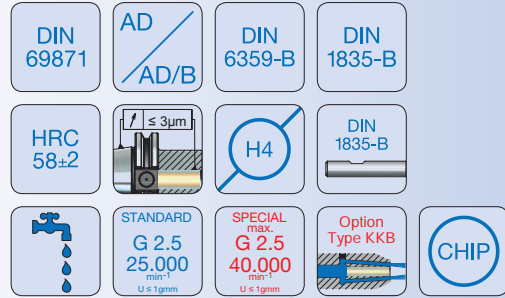

Bestell-Nr. Order Nr. Reference Sipariş Nr.	SK	Form	d	A	D	D1	L1	L2	Kg	Euro
502.04.12.63	SK 50	AD	12	63	42	-	-	51	3,00	
503.04.12.63	SK 50	AD/B	12	63	42	-	-	51	2,99	
502.04.12.100	SK 50	AD	12	100	42	-	-	51	3,37	
503.04.12.100	SK 50	AD/B	12	100	42	-	-	51	3,35	
502.04.12.130	SK 50	AD	12	130	42	-	-	51	3,67	
503.04.12.130	SK 50	AD/B	12	130	42	-	-	51	3,65	
502.04.12.160	SK 50	AD	12	160	42	47,5	88	51	4,05	
503.04.12.160	SK 50	AD/B	12	160	42	47,5	88	51	4,03	
503.04.12.200	SK 50	AD/B	12	200	42	47,5	120	51	4,47	
502.04.14.63	SK 50	AD	14	63	44	-	-	51	3,03	
503.04.14.63	SK 50	AD/B	14	63	44	-	-	51	3,01	
502.04.14.100	SK 50	AD	14	100	44	-	-	51	3,44	
503.04.14.100	SK 50	AD/B	14	100	44	-	-	51	3,42	
502.04.14.130	SK 50	AD	14	130	44	-	-	51	3,77	
503.04.14.130	SK 50	AD/B	14	130	44	-	-	51	3,75	
502.04.14.160	SK 50	AD	14	160	44	49,5	88	51	4,18	
503.04.14.160	SK 50	AD/B	14	160	44	49,5	88	51	4,17	
503.04.14.200	SK 50	AD/B	14	200	44	49,5	120	51	4,65	
502.04.16.63	SK 50	AD	16	63	48	-	-	54	3,10	
503.04.16.63	SK 50	AD/B	16	63	48	-	-	54	3,08	
502.04.16.100	SK 50	AD	16	100	48	-	-	54	3,59	
503.04.16.100	SK 50	AD/B	16	100	48	-	-	54	3,57	
502.04.16.130	SK 50	AD	16	130	48	-	-	54	3,99	
503.04.16.130	SK 50	AD/B	16	130	48	-	-	54	3,97	
502.04.16.160	SK 50	AD	16	160	48	53,5	88	54	4,48	
503.04.16.160	SK 50	AD/B	16	160	48	53,5	88	54	4,46	
503.04.16.200	SK 50	AD/B	16	200	48	53,5	120	54	5,04	

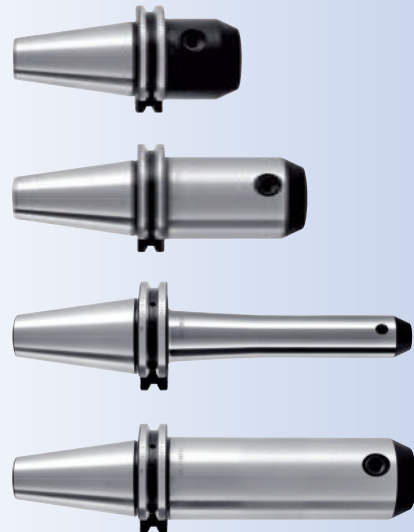
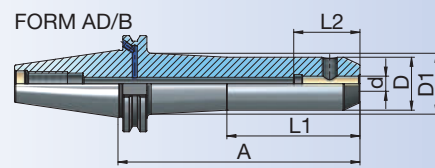
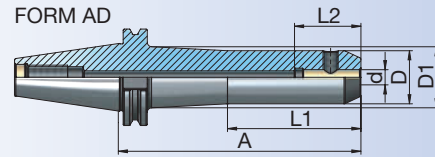

## Zubehör / Accessories / Accessoires / Yedekler

<p>DIN 1835 B</p> <p>10.38</p>	<p>Spannschrauben Clamping screw Vis de serrage Sıkma civatası</p>	<p>11.05</p>
--------------------------------	--	--------------



## Fräseraufnahmen

End mill holder

Porte-fraises

Veldon tutucu

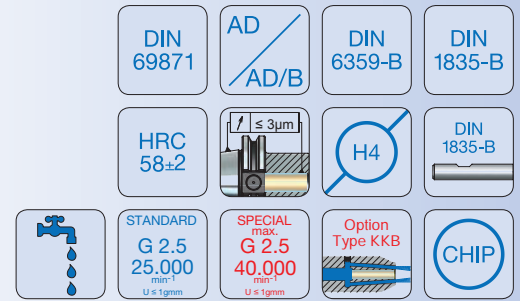

Bestell-Nr. Order Nr. Reference Sipariş Nr.	SK	Form	d	A	D	D1	L1	L2	Kg	Euro
502.04.18.63	SK 50	AD	18	63	50	-	-	54	3,13	
503.04.18.63	SK 50	AD/B	18	63	50	-	-	54	3,11	
502.04.18.100	SK 50	AD	18	100	50	-	-	54	3,66	
503.04.18.100	SK 50	AD/B	18	100	50	-	-	54	3,64	
502.04.18.130	SK 50	AD	18	130	50	-	-	54	4,10	
503.04.18.130	SK 50	AD/B	18	130	50	-	-	54	4,08	
502.04.18.160	SK 50	AD	18	160	50	55,5	88	54	4,62	
503.04.18.160	SK 50	AD/B	18	160	50	55,5	88	54	4,61	
503.04.18.200	SK 50	AD/B	18	200	50	55,5	120	54	5,24	
502.04.20.63	SK 50	AD	20	63	52	-	-	56	3,14	
503.04.20.63	SK 50	AD/B	20	63	52	-	-	56	3,13	
502.04.20.100	SK 50	AD	20	100	52	-	-	56	3,72	
503.04.20.100	SK 50	AD/B	20	100	52	-	-	56	3,71	
502.04.20.130	SK 50	AD	20	130	52	-	-	56	4,20	
503.04.20.130	SK 50	AD/B	20	130	52	-	-	56	4,18	
502.04.20.160	SK 50	AD	20	160	52	57,5	88	56	4,77	
503.04.20.160	SK 50	AD/B	20	160	52	57,5	88	56	4,75	
503.04.20.200	SK 50	AD/B	20	200	52	58	120	56	5,41	
502.04.25.80	SK 50	AD	25	80	63	-	-	64	3,74	
503.04.25.80	SK 50	AD/B	25	80	63	-	-	64	3,73	
502.04.25.100	SK 50	AD	25	100	63	-	-	64	4,21	
503.04.25.100	SK 50	AD/B	25	100	63	-	-	64	4,2	
502.04.25.120	SK 50	AD	25	120	63	-	-	64	4,68	
503.04.25.120	SK 50	AD/B	25	120	63	-	-	64	4,67	
502.04.25.130	SK 50	AD	25	130	63	-	-	64	4,92	
503.04.25.130	SK 50	AD/B	25	130	63	-	-	64	4,91	
502.04.25.160	SK 50	AD	25	160	63	68,5	88	64	5,73	
503.04.25.160	SK 50	AD/B	25	160	63	68,5	88	64	5,72	

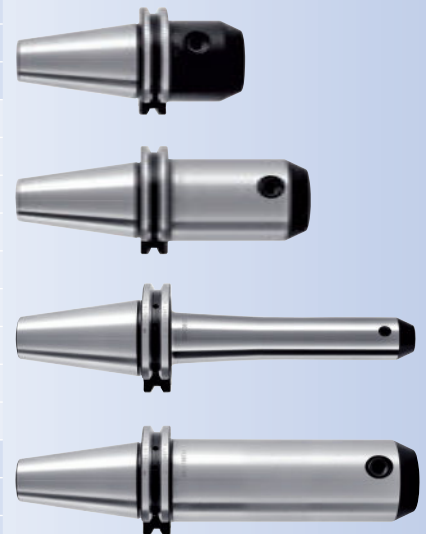
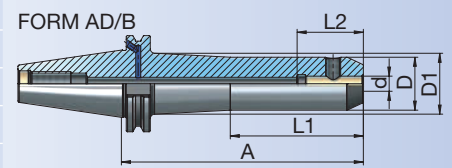
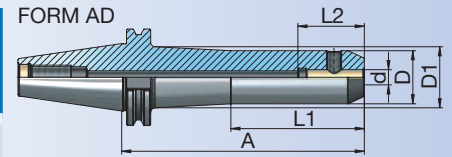

## Zubehör / Accessories / Accessoires / Yedekler



Spannschrauben  
Clamping screw  
Vis de serrage  
Sıkma civatası





## Fräseraufnahmen

End mill holder

Porte-fraises

Veldon tutucu

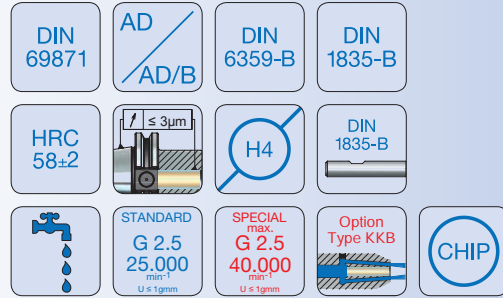

Bestell-Nr. Order Nr. Reference Sipariş Nr.	SK	Form	d	A	D	D1	L1	L2	Kg	Euro
502.04.32.100	SK 50	AD	32	100	72	-	-	68	4,63	
503.04.32.100	SK 50	AD/B	32	100	72	-	-	68	4,61	
502.04.32.130	SK 50	AD	32	130	72	-	-	68	5,55	
503.04.32.130	SK 50	AD/B	32	130	72	-	-	68	5,54	
502.04.32.160	SK 50	AD	32	160	72	-	-	68	6,48	
503.04.32.160	SK 50	AD/B	32	160	72	-	-	68	6,46	
502.04.40.100	SK 50	AD	40	100	80	-	-	78	4,84	
503.04.40.100	SK 50	AD/B	40	100	80	-	-	78	4,82	
502.04.40.130	SK 50	AD	40	130	80	-	-	78	5,99	
503.04.40.130	SK 50	AD/B	40	130	80	-	-	78	5,97	
502.04.40.160	SK 50	AD	40	160	80	-	-	78	7,14	
503.04.40.160	SK 50	AD/B	40	160	80	-	-	78	7,12	

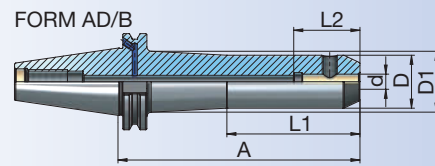
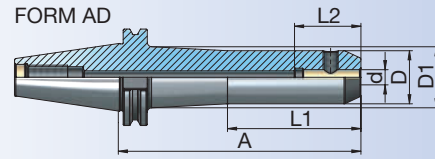

## Zubehör / Accessories / Accessoires / Yedekler



Spannschrauben  
Clamping screw  
Vis de serrage  
Sıkma civatası





## Fräseraufnahmen mit Kühlkanal

End mill holder with coolant channel

Porte-fraises avec canal d'arrosage

Veldon tutucu içten soğutma kanallı

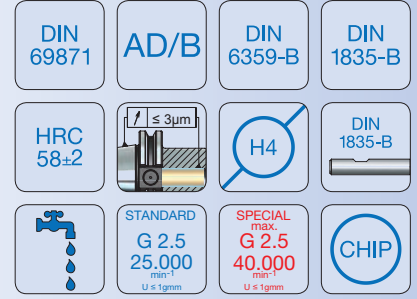

Bestell-Nr. Order Nr. Reference Sipariş Nr.	SK	Form	d	A	D	L2	Kg	Euro
403.04.06.50.K	SK 40	AD/B	6	50	25	36	0,90	
403.04.06.100.K	SK 40	AD/B	6	100	25	36	1,07	
403.04.08.50.K	SK 40	AD/B	8	50	28	40	0,93	
403.04.08.100.K	SK 40	AD/B	8	100	28	40	1,15	
403.04.10.50.K	SK 40	AD/B	10	50	35	44	0,97	
403.04.10.100.K	SK 40	AD/B	10	100	35	44	1,30	
403.04.12.50.K	SK 40	AD/B	12	50	42	51	1,05	
403.04.12.100.K	SK 40	AD/B	12	100	42	51	1,54	
403.04.14.50.K	SK 40	AD/B	14	50	44	51	1,06	
403.04.14.100.K	SK 40	AD/B	14	100	44	51	1,61	
403.04.16.63.K	SK 40	AD/B	16	63	48	54	1,27	
403.04.16.100.K	SK 40	AD/B	16	100	48	54	1,75	
403.04.18.63.K	SK 40	AD/B	18	63	50	54	1,29	
403.04.18.100.K	SK 40	AD/B	18	100	50	54	1,82	
403.04.20.63.K	SK 40	AD/B	20	63	52	56	1,29	
403.04.20.100.K	SK 40	AD/B	20	100	52	56	1,87	
403.04.25.100.K	SK 40	AD/B	25	100	63	64	2,22	
403.04.32.100.K	SK 40	AD/B	32	100	72	68	2,52	
403.04.40.120.K	SK 40	AD/B	40	120	80	78	3,38	

503.04.06.63.K	SK 50	AD/B	6	63	25	36	2,75	
503.04.08.63.K	SK 50	AD/B	8	63	28	40	2,79	
503.04.10.63.K	SK 50	AD/B	10	63	35	44	2,86	
503.04.12.63.K	SK 50	AD/B	12	63	42	51	2,98	
503.04.14.63.K	SK 50	AD/B	14	63	44	51	3,01	
503.04.16.63.K	SK 50	AD/B	16	63	48	54	3,07	
503.04.18.63.K	SK 50	AD/B	18	63	50	54	3,10	
503.04.20.63.K	SK 50	AD/B	20	63	52	56	3,11	
503.04.25.80.K	SK 50	AD/B	25	80	63	64	3,70	
503.04.32.100.K	SK 50	AD/B	32	100	72	68	4,59	
503.04.40.100.K	SK 50	AD/B	40	100	80	78	4,79	

FORM AD/B

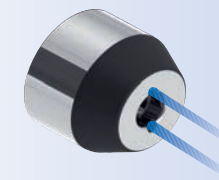
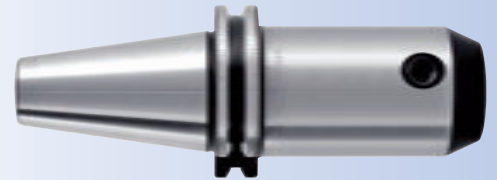
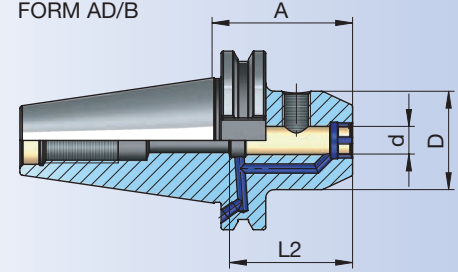

d  
6 - 18  
(2 Holes)  
(2 Delik)

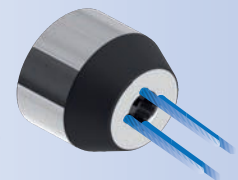

d  
20 - 40  
(4 Holes)  
(4 Delik)

## Zubehör / Accessories / Accessoires / Yedekler



Spannschrauben  
Clamping screw  
Vis de serrage  
Sıkma civatası



11.05





## Fräseraufnahmen 2° Whistle-Notch

End mill holder 2°

Porte-fraises 2°

Veldon tutucu 2°

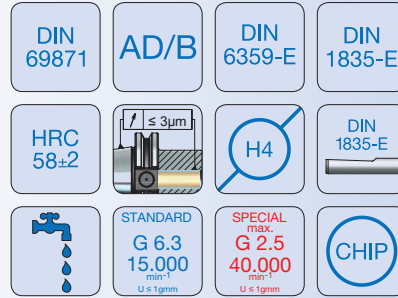

Bestell-Nr. Order Nr. Reference Sipariş Nr.	SK	Form	d	A	D	L2	Kg	Euro
403.05.06.50	SK 40	AD/B	6	50	25	36	0,91	
403.05.08.50	SK 40	AD/B	8	50	28	40	0,94	
403.05.10.50	SK 40	AD/B	10	50	35	44	0,99	
403.05.12.50	SK 40	AD/B	12	50	42	51	1,07	
403.05.14.50	SK 40	AD/B	14	50	44	51	1,08	
403.05.16.63	SK 40	AD/B	16	63	48	54	1,29	
403.05.18.63	SK 40	AD/B	18	63	50	54	1,32	
403.05.20.63	SK 40	AD/B	20	63	52	56	1,32	
403.05.25.100	SK 40	AD/B	25	100	63	64	2,25	
403.05.32.100	SK 40	AD/B	32	100	72	68	2,55	
403.05.40.120	SK 40	AD/B	40	120	80	78	3,43	

503.05.06.63	SK 50	AD/B	6	63	25	36	2,76	
503.05.08.63	SK 50	AD/B	8	63	28	40	2,80	
503.05.10.63	SK 50	AD/B	10	63	35	44	2,88	
503.05.12.63	SK 50	AD/B	12	63	42	51	3,00	
503.05.14.63	SK 50	AD/B	14	63	44	51	3,03	
503.05.16.63	SK 50	AD/B	16	63	48	59	3,09	
503.05.18.63	SK 50	AD/B	18	63	50	59	3,12	
503.05.20.63	SK 50	AD/B	20	63	52	58	3,14	
503.05.25.80	SK 50	AD/B	25	80	63	74	3,70	
503.05.32.100	SK 50	AD/B	32	100	72	68	4,62	
503.05.40.100	SK 50	AD/B	40	100	80	78	4,84	

FORM AD/B

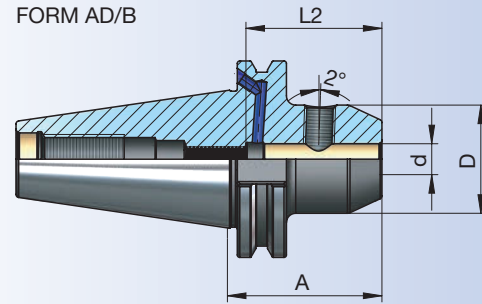

### Zubehör / Accessories / Accessoires / Yedekler

DIN 1835 B



Spannschrauben  
Clamping screw  
Vis de serrage  
Sıkma civatası

10.38

DIN 916



Einstellschraube  
Adjusting screw  
Vis de réglage  
Dayama civatası

10.41 - 10.43



## Hochgenauigkeits-Spannzangenfutter

High precision pull type collet chuck

Mandrin de serrage de précision

Hassas çekirmeli pens başlığı

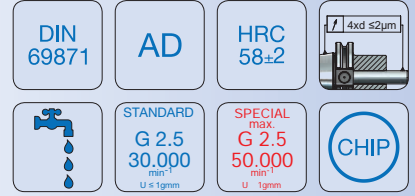

Bestell-Nr. Order Nr. Reference Sipariş Nr.	SK	Form	Spannbereich Capacity Capacité Kapasite	A	D	D1	L	L1	Kg	Euro
<b>new</b> 402.06.06.115	SK 40	AD	EPC (3-6)	115	14	-	50	-	1,54	
<b>new</b> 402.06.06.140	SK 40	AD	EPC (3-6)	140	14	16,7	75	40	1,58	
<b>new</b> 402.06.06.165	SK 40	AD	EPC (3-6)	165	14	19,3	100	40	1,63	
<b>new</b> 402.06.06.215	SK 40	AD	EPC (3-6)	215	14	24,8	150	40	1,78	
<b>new</b> 402.06.08.115	SK 40	AD	EPC (3-8)	115	20	-	50	-	1,59	
<b>new</b> 402.06.08.140	SK 40	AD	EPC (3-8)	140	20	22,9	75	40	1,66	
<b>new</b> 402.06.08.165	SK 40	AD	EPC (3-8)	165	20	25,7	100	40	1,75	
<b>new</b> 402.06.08.215	SK 40	AD	EPC (3-8)	215	20	31,2	150	40	2,00	
<b>new</b> 402.06.12.140	SK 40	AD	EPC (3-12)	140	26	28,1	75	50	1,72	
<b>new</b> 402.06.12.165	SK 40	AD	EPC (3-12)	165	26	30,9	100	50	1,85	
<b>new</b> 402.06.12.215	SK 40	AD	EPC (3-12)	215	26	34,7	150	50	2,15	
<b>new</b> 402.06.16.140	SK 40	AD	EPC (3-16)	140	30	-	75	-	1,74	
<b>new</b> 402.06.16.165	SK 40	AD	EPC (3-16)	165	30	34,1	100	60	1,91	
<b>new</b> 402.06.16.215	SK 40	AD	EPC (3-16)	215	30	34,7	150	60	2,23	

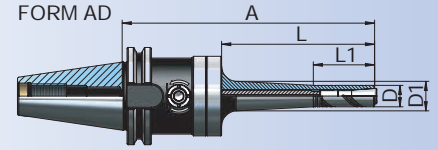

Spannzangen Größe Collet size Diamètre de pince Pens ölçüsü (mm)	Max. Anzugskraft Max. Clamping torque Couple max. Max. Sıkma torku (Nm)	Max. Haltekraft Max. Holding torque Force de serrage Max. Tutma torku (Nm)
EPC 6 (Ø3-Ø6)	4	16
EPC 8 (Ø3-Ø8)	15	50
EPC 12 (Ø3-Ø12)	20	160
EPC 16 (Ø3-Ø16)	25	260

### Zubehör / Accessories / Accessoires / Yedekler

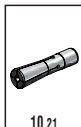

Spannzangen  
Collets  
Pincés de serrage  
Pens



Spannschlüssel  
Wrench  
Clé de serrage  
Sıkma anahtarı





## Hochgenauigkeits-Spannzangenfutter

High precision pull type collet chuck

Mandrin de serrage de précision

Hassas çekmeli pens başlığı



Bestell-Nr. Order Nr. Reference Sipariş Nr.	SK	Form	Spannbereich Capacity Capacité Kapasite	A	D	D1	L	L1	Kg	Euro
<b>new</b> 502.06.06.115	SK 50	AD	EPC (3-6)	115	14	-	50	-	3,35	
<b>new</b> 502.06.06.140	SK 50	AD	EPC (3-6)	140	14	16,7	75	40	3,40	
<b>new</b> 502.06.06.165	SK 50	AD	EPC (3-6)	165	14	19,3	100	40	3,45	
<b>new</b> 502.06.06.215	SK 50	AD	EPC (3-6)	215	14	24,8	150	40	3,59	
<b>new</b> 502.06.08.115	SK 50	AD	EPC (3-8)	115	20	-	50	-	3,41	
<b>new</b> 502.06.08.140	SK 50	AD	EPC (3-8)	140	20	22,9	75	40	3,48	
<b>new</b> 502.06.08.165	SK 50	AD	EPC (3-8)	165	20	25,7	100	40	3,57	
<b>new</b> 502.06.08.215	SK 50	AD	EPC (3-8)	215	20	31,2	150	40	3,82	
<b>new</b> 502.06.12.140	SK 50	AD	EPC (3-12)	140	26	28,1	75	50	3,54	
<b>new</b> 502.06.12.165	SK 50	AD	EPC (3-12)	165	26	30,9	100	50	3,66	
<b>new</b> 502.06.12.215	SK 50	AD	EPC (3-12)	215	26	34,7	150	50	3,97	
<b>new</b> 502.06.16.140	SK 50	AD	EPC (3-16)	140	30	-	75	-	3,56	
<b>new</b> 502.06.16.165	SK 50	AD	EPC (3-16)	165	30	34,1	100	60	3,73	
<b>new</b> 502.06.16.215	SK 50	AD	EPC (3-16)	215	30	34,7	150	60	4,05	

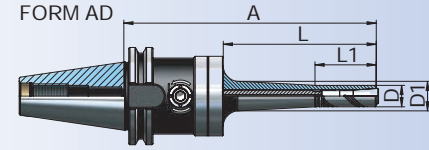

Spannzangen Größe Collet size Diamètre de pince Pens ölçüsü (mm)	Max. Anzugskraft Max. Clamping torque Couple max. Max. Sıkma torku (Nm)	Max. Haltekraft Max. Holding torque Force de serrage Max. Tutma torku (Nm)
EPC 6 (Ø3-Ø6)	4	16
EPC 8 (Ø3-Ø8)	15	50
EPC 12 (Ø3-Ø12)	20	160
EPC 16 (Ø3-Ø16)	25	260

### Zubehör / Accessories / Accessoires / Yedekler

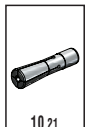

Spannzangen  
Collets  
Pincés de serrage  
Pens

10.21



Spannschlüssel  
Wrench  
Clé de serrage  
Sıkma anahtarı

10.49



11.12



## Hochgenauigkeits-Spannzangenfutter im Koffer

High precision pull type collet chuck set in box

Mandrin de serrage de précision (set) dans coffre

Hassas çekmeli pens başlığı seti plastik kutuda

DIN  
69871

AD

HRC  
58±2



CHIP

Bestell-Nr. Order Nr. Reference Sipariş Nr.	SK	Form	Spannbereich Capacity Capacité Kapasite	Spannzangen Durchmesser Collet Diameter Pinces Diamètre Pens Çapı	Spannzangen Stk. Collet Pcs. Pinces Pens Adedi	Kg	Euro
<b>new</b> 402.67.06.115	SK 40	AD	EPC (3 - 6)	3-4-5-6	4	2,50	
<b>new</b> 402.67.08.115	SK 40	AD	EPC (3 - 8)	3-4-5-6-8	5	2,63	
<b>new</b> 402.67.12.140	SK 40	AD	EPC (3 - 12)	6-8-10-12	5	2,84	
<b>new</b> 402.67.16.140	SK 40	AD	EPC (3 - 16)	6-8-10-12-16	5	3,20	
<b>new</b> 502.67.06.115	SK 50	AD	EPC (3 - 6)	3-4-5-6	4	4,31	
<b>new</b> 502.67.08.115	SK 50	AD	EPC (3 - 8)	3-4-5-6-8	5	4,45	
<b>new</b> 502.67.12.140	SK 50	AD	EPC (3 - 12)	6-8-10-12	5	4,66	
<b>new</b> 502.67.16.140	SK 50	AD	EPC (3 - 16)	6-8-10-12-16	5	5,02	



Lieferumfang : Spannfutter, inkl. Spannzangen mit Schlüssel

Included : Collet chuck with collets and wrench

Inclus : Mandrin avec pinces et clé

Teslim Şekli : Tutucu, pensleri ve anahtarıyla birlikte

### Zubehör / Accessories / Accessoires / Yedekler



Spannzangen  
Collets  
Pinces de serrage  
Pens

10.21



Spannschlüssel  
Wrench  
Clé de serrage  
Sıkma anahtarı

10.49



i

11.12



## Morsekegel-Aufnahmen mit Austreibblappen

### Morse taper adaptor

### Douilles intermédiaires pour outils à cône Morse

### Mors adaptörü

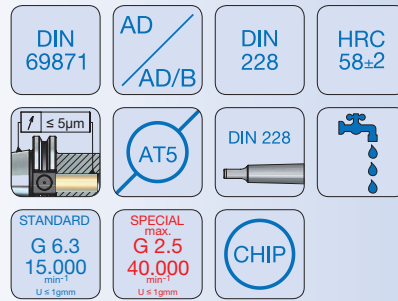

Bestell-Nr. Order Nr. Reference Sipariş Nr.	SK	Form	MK	A	D	Kg	Euro
302.07.01.50	SK 30	AD	MK 1	50	25	0,44	
302.07.02.65	SK 30	AD	MK 2	65	32	0,53	
302.07.03.80	SK 30	AD	MK 3	80	40	0,68	
402.07.01.50	SK 40	AD	MK 1	50	25	0,87	
403.07.01.50	SK 40	AD/B	MK 1	50	25	0,97	
402.07.02.50	SK 40	AD	MK 2	50	32	0,88	
403.07.02.50	SK 40	AD/B	MK 2	50	32	0,94	
402.07.02.117	SK 40	AD	MK 2	117	32	1,27	
402.07.03.70	SK 40	AD	MK 3	70	40	1,03	
403.07.03.70	SK 40	AD/B	MK 3	70	40	1,02	
402.07.03.133	SK 40	AD	MK 3	133	40	1,61	
402.07.04.95	SK 40	AD	MK 4	95	48	1,26	
403.07.04.95	SK 40	AD/B	MK 4	95	48	1,25	
402.07.04.156	SK 40	AD	MK 4	156	48	2,06	
502.07.01.45	SK 50	AD	MK 1	45	25	2,61	
503.07.01.45	SK 50	AD/B	MK 1	45	25	3,11	
502.07.02.60	SK 50	AD	MK 2	60	32	2,69	
503.07.02.60	SK 50	AD/B	MK 2	60	32	3,25	
502.07.02.117	SK 50	AD	MK 2	117	32	3,06	
502.07.03.65	SK 50	AD	MK 3	65	40	2,72	
503.07.03.65	SK 50	AD/B	MK 3	65	40	3,09	
502.07.03.137	SK 50	AD	MK 3	137	40	3,40	
502.07.04.95	SK 50	AD	MK 4	95	48	3,01	
503.07.04.95	SK 50	AD/B	MK 4	95	48	3,19	
502.07.04.167	SK 50	AD	MK 4	167	48	3,97	
502.07.05.105	SK 50	AD	MK 5	105	63	3,18	
503.07.05.105	SK 50	AD/B	MK 5	105	63	3,22	
502.07.05.197	SK 50	AD	MK 5	197	63	5,19	

FORM AD

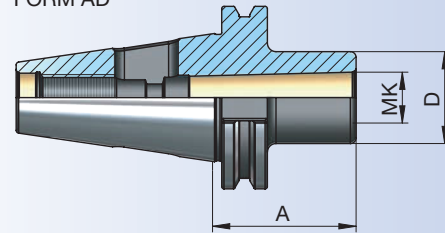

FORM AD/B

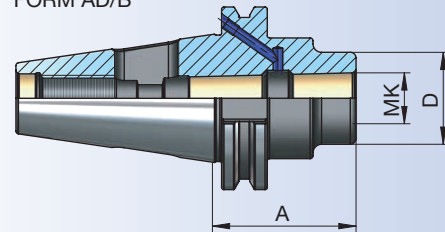



## Zwischenhülsen für MK mit Anzuggewinde

Morse taper adaptor for tools with morse taper shank and drawbar thread

Douilles intermédiaires pour outils à cône Morse à trou fileté

Mors adaptörü çekirme civatalı

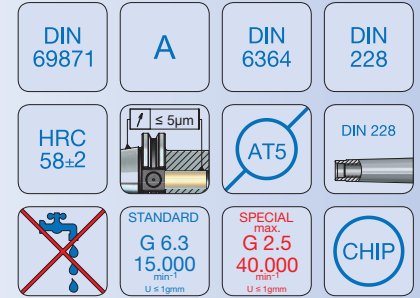

Bestell-Nr. Order Nr. Reference Sipariş Nr.	SK	Form	MK	A	D	Kg	Euro
402.08.01.50	SK 40	A	MK 1	50	25	0,91	
402.08.02.50	SK 40	A	MK 2	50	32	0,93	
402.08.03.70	SK 40	A	MK 3	70	40	1,10	
402.08.04.95	SK 40	A	MK 4	95	48	1,39	
*402.08.04A.110	SK 40	A	MK 4	110	63	2,20	

502.08.01.45	SK 50	A	MK 1	45	25	2,71	
502.08.02.60	SK 50	A	MK 2	60	32	2,80	
502.08.03.65	SK 50	A	MK 3	65	40	2,89	
502.08.04.70	SK 50	A	MK 4	70	48	2,92	
*502.08.04A.85	SK 50	A	MK 4	85	63	3,61	
502.08.05.100	SK 50	A	MK 5	100	63	3,32	
*502.08.05A.118	SK 50	A	MK 5	118	78	4,63	

- \* Mit Mitnahmeausfräsung nach DIN 2201
- \* With driving facilities to DIN 2201
- \* Avec douille d'accouplement de fraisure DIN 2201
- \* Taşıyıcı yuvalı DIN 2201

FORM A

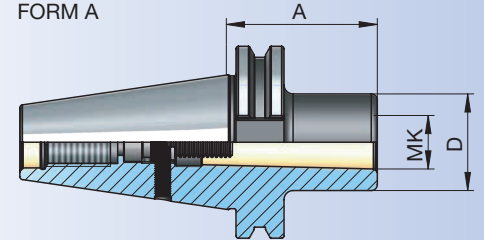

## Adapter / Reduzierungen

Reduction Sleeves

Douilles de réduction

Çekirme civatalı redüksiyon

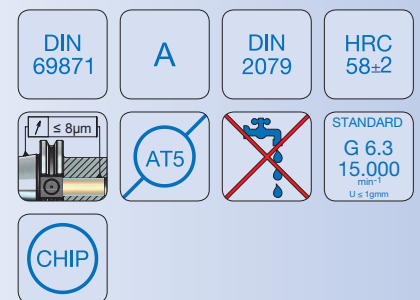

Bestell-Nr. Order Nr. Reference Sipariş Nr.	SK	Form	SK <sub>1</sub>	A	D	Kg	Euro
402.09.30.50	SK 40	A	SK 30	50	50	1,10	
402.09.40.100	SK 40	A	SK 40	100	63	2,10	
502.09.40.70	SK 50	A	SK 40	70	70	3,68	
502.09.50.120	SK 50	A	SK 50	120	97	5,97	

FORM A

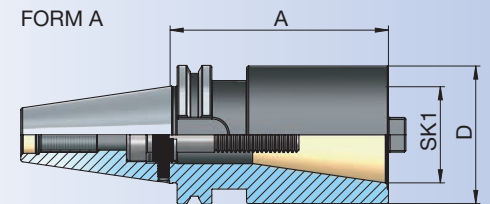



## Kombi - Aufsteckfräserdorne

### Combi shell mill holder

Porte-fraises à double usage pour fraises à entraînement par clavette ou tenon

### Kombine malafa

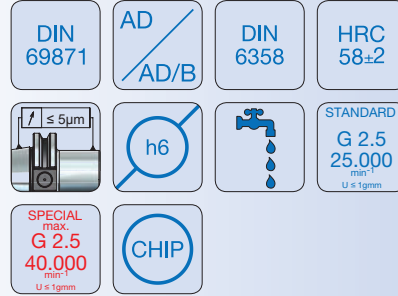

Bestell-Nr. Order Nr. Reference Sipariş Nr.	SK	Form	d	A	D	D1	L1	L3	L4	Kg	Euro
302.10.16.50	SK 30	AD	16	50	32	-	-	17	27	0,60	
302.10.22.50	SK 30	AD	22	50	40	-	-	19	31	0,74	
302.10.27.55	SK 30	AD	27	55	48	-	-	21	33	0,94	
302.10.32.60	SK 30	AD	32	60	58	-	-	24	38	1,22	
402.10.16.55	SK 40	AD	16	55	32	-	-	17	27	1,06	
403.10.16.55	SK 40	AD/B	16	55	32	-	-	17	27	1,05	
402.10.16.100	SK 40	AD	16	100	32	-	-	17	27	1,32	
403.10.16.100	SK 40	AD/B	16	100	32	-	-	17	27	1,32	
402.10.16.130	SK 40	AD	16	130	32	-	-	17	27	1,50	
403.10.16.130	SK 40	AD/B	16	130	32	-	-	17	27	1,49	
402.10.16.160	SK 40	AD	16	160	32	39	88	17	27	1,78	
403.10.16.160	SK 40	AD/B	16	160	32	39	88	17	27	1,77	
403.10.16.200	SK 40	AD/B	16	200	32	40	120	17	27	2,03	
402.10.22.55	SK 40	AD	22	55	40	-	-	19	31	1,20	
403.10.22.55	SK 40	AD/B	22	55	40	-	-	19	31	1,19	
402.10.22.100	SK 40	AD	22	100	40	-	-	19	31	1,60	
403.10.22.100	SK 40	AD/B	22	100	40	-	-	19	31	1,59	
402.10.22.130	SK 40	AD	22	130	40	-	-	19	31	1,87	
403.10.22.130	SK 40	AD/B	22	130	40	-	-	19	31	1,86	
402.10.22.160	SK 40	AD	22	160	40	47,5	88	19	31	2,28	
403.10.22.160	SK 40	AD/B	22	160	40	47,5	88	19	31	2,27	
403.10.22.200	SK 40	AD/B	22	200	40	48,5	120	19	31	2,66	

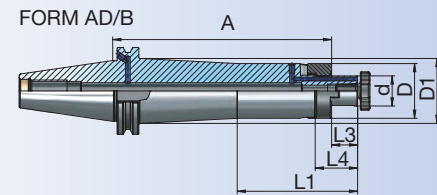
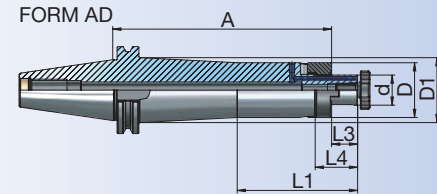

### Zubehör / Accessories / Accessoires / Yedekler

DIN 6366



10.46

Mitnehmerringe  
Clutch drive rings to  
Bague d'entraînement  
Tırnaklı pul

DIN 6367



10.45

Fräseranzugsschrauben  
Drawn in bolt  
Vis de serrage  
Alın sıkma civatası

DIN 6885



10.44

Paßfeder  
Drive key  
Ressort de passage  
Kama

DIN 6388



10.46

Spannschlüssel für Aufsteckdorne  
Wrench  
Clé de serrage  
Alın civatası sıkma anahtarı



## Kombi - Aufsteckfräserdorne

### Combi shell mill holder

Porte-fraises à double usage pour fraises à entraînement par clavette ou tenon

Kombine malafa

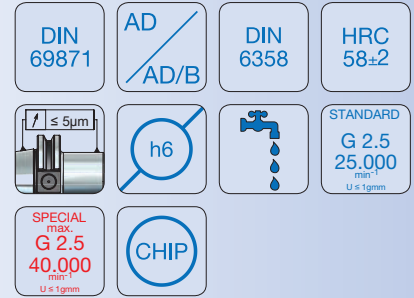

Bestell-Nr. Order Nr. Reference Sipariş Nr.	SK	Form	d	A	D	D1	L1	L3	L4	Kg	Euro
402.10.27.55	SK 40	AD	27	55	48	-	-	21	33	1,40	
403.10.27.55	SK 40	AD/B	27	55	48	-	-	21	33	1,39	
402.10.27.100	SK 40	AD	27	100	48	-	-	21	33	2,00	
403.10.27.100	SK 40	AD/B	27	100	48	-	-	21	33	1,98	
402.10.27.130	SK 40	AD	27	130	48	-	-	21	33	2,39	
403.10.27.130	SK 40	AD/B	27	130	48	-	-	21	33	2,38	
402.10.27.160	SK 40	AD	27	160	48	-	-	21	33	2,79	
403.10.27.160	SK 40	AD/B	27	160	48	-	-	21	33	2,78	
403.10.27.200	SK 40	AD/B	27	200	48	-	-	21	33	3,30	
402.10.32.60	SK 40	AD	32	60	58	-	-	24	38	1,71	
403.10.32.60	SK 40	AD/B	32	60	58	-	-	24	38	1,69	
402.10.32.100	SK 40	AD	32	100	58	-	-	24	38	2,51	
403.10.32.100	SK 40	AD/B	32	100	58	-	-	24	38	2,48	
402.10.32.130	SK 40	AD	32	130	58	-	-	24	38	3,10	
403.10.32.130	SK 40	AD/B	32	130	58	-	-	24	38	3,08	
402.10.32.160	SK 40	AD	32	160	58	-	-	24	38	3,69	
403.10.32.160	SK 40	AD/B	32	160	58	-	-	24	38	3,67	
403.10.32.200	SK 40	AD/B	32	200	58	-	-	24	38	4,46	
402.10.40.60	SK 40	AD	40	60	70	-	-	27	41	2,11	
403.10.40.60	SK 40	AD/B	40	60	70	-	-	27	41	2,08	

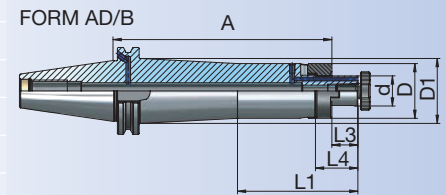
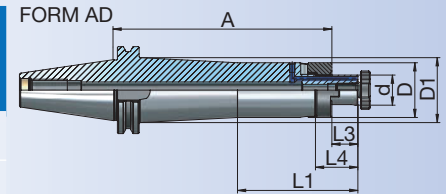

### Zubehör / Accessories / Accessoires / Yedekler

DIN 6366



10.46

Mitnehmerringe  
Clutch drive rings to  
Bague d'entraînement  
Tırnaklı pul

DIN 6367



10.45

Fräseranzugsschrauben  
Drawn in bolt  
Vis de serrage  
Alın sıkma civatası

DIN 6885



10.44

Paßfeder  
Drive key  
Ressort de passage  
Kama

DIN 6388



10.46

Spannschlüssel für Aufsteckdorne  
Wrench  
Clé de serrage  
Alın civatası sıkma anahtarı





## Kombi - Aufsteckfräserdorne

### Combi shell mill holder

Porte-fraises à double usage pour fraises à entraînement par clavette ou tenon

### Kombine malafa

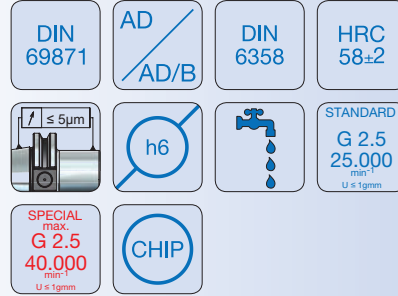

Bestell-Nr. Order Nr. Reference Sipariş Nr.	SK	Form	d	A	D	D1	L1	L3	L4	Kg	Euro
502.10.16.55	SK 50	AD	16	55	32	-	-	17	27	2,88	
503.10.16.55	SK 50	AD/B	16	55	32	-	-	17	27	2,86	
502.10.16.100	SK 50	AD	16	100	32	-	-	17	27	3,14	
503.10.16.100	SK 50	AD/B	16	100	32	-	-	17	27	3,13	
502.10.16.130	SK 50	AD	16	130	32	-	-	17	27	3,33	
503.10.16.130	SK 50	AD/B	16	130	32	-	-	17	27	3,31	
502.10.16.160	SK 50	AD	16	160	32	38,5	88	17	27	3,62	
503.10.16.160	SK 50	AD/B	16	160	32	38,5	88	17	27	3,60	
503.10.16.200	SK 50	AD/B	16	200	32	39	120	17	27	3,89	
502.10.22.55	SK 50	AD	22	55	40	-	-	19	31	3,02	
503.10.22.55	SK 50	AD/B	22	55	40	-	-	19	31	3,00	
502.10.22.100	SK 50	AD	22	100	40	-	-	19	31	3,42	
503.10.22.100	SK 50	AD/B	22	100	40	-	-	19	31	3,40	
502.10.22.130	SK 50	AD	22	130	40	-	-	19	31	3,70	
503.10.22.130	SK 50	AD/B	22	130	40	-	-	19	31	3,68	
502.10.22.160	SK 50	AD	22	160	40	47	88	19	31	4,11	
503.10.22.160	SK 50	AD/B	22	160	40	47	88	19	31	4,09	
503.10.22.200	SK 50	AD/B	22	200	40	47,5	120	19	31	4,48	
502.10.27.55	SK 50	AD	27	55	48	-	-	21	33	3,22	
503.10.27.55	SK 50	AD/B	27	55	48	-	-	21	33	3,20	
502.10.27.100	SK 50	AD	27	100	48	-	-	21	33	3,82	
503.10.27.100	SK 50	AD/B	27	100	48	-	-	21	33	3,79	
502.10.27.130	SK 50	AD	27	130	48	-	-	21	33	4,23	
503.10.27.130	SK 50	AD/B	27	130	48	-	-	21	33	4,21	
502.10.27.160	SK 50	AD	27	160	48	55	88	21	33	4,81	
503.10.27.160	SK 50	AD/B	27	160	48	55	88	21	33	4,79	
503.10.27.200	SK 50	AD/B	27	200	48	56	120	21	33	5,36	

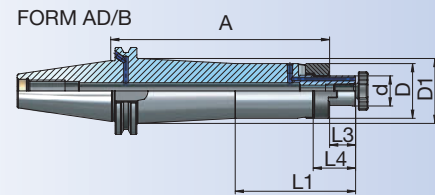
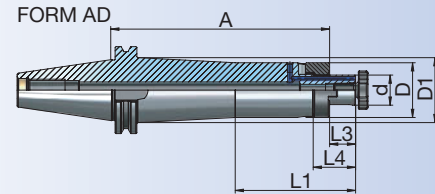

### Zubehör / Accessories / Accessoires / Yedekler

DIN 6366



10.46

Mitnehmerringe  
Clutch drive rings to  
Bague d'entraînement  
Tırnaklı pul

DIN 6367



10.45

Fräseranzugsschrauben  
Drawn in bolt  
Vis de serrage  
Alın sıkma civatası

DIN 6885



10.44

Paßfeder  
Drive key  
Ressort de passage  
Kama

DIN 6388



10.46

Spannschlüssel für Aufsteckdorne  
Wrench  
Clé de serrage  
Alın civatası sıkma anahtarı



## Kombi - Aufsteckfräserdorne

### Combi shell mill holder

Porte-fraises à double usage pour fraises à entraînement par clavette ou tenon

Kombine malafa

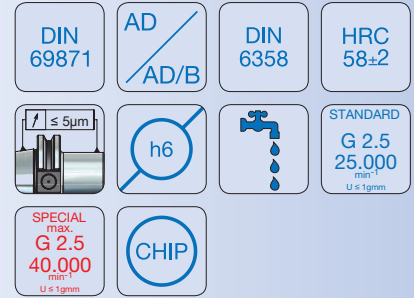

Bestell-Nr. Order Nr. Reference Sipariş Nr.	SK	Form	d	A	D	D1	L1	L3	L4	Kg	Euro
502.10.32.55	SK 50	AD	32	55	58	-	-	24	38	3,53	
503.10.32.55	SK 50	AD/B	32	55	58	-	-	24	38	3,50	
502.10.32.100	SK 50	AD	32	100	58	-	-	24	38	4,42	
503.10.32.100	SK 50	AD/B	32	100	58	-	-	24	38	4,39	
502.10.32.130	SK 50	AD	32	130	58	-	-	24	38	5,01	
503.10.32.130	SK 50	AD/B	32	130	58	-	-	24	38	4,98	
502.10.32.160	SK 50	AD	32	160	58	66	88	24	38	5,83	
503.10.32.160	SK 50	AD/B	32	160	58	66	88	24	38	5,80	
503.10.32.200	SK 50	AD/B	32	200	58	66,5	120	24	38	6,64	
502.10.40.55	SK 50	AD	40	55	70	-	-	27	41	4,01	
503.10.40.55	SK 50	AD/B	40	55	70	-	-	27	41	3,97	
502.10.40.100	SK 50	AD	40	100	70	-	-	27	41	5,33	
503.10.40.100	SK 50	AD/B	40	100	70	-	-	27	41	5,29	
502.10.40.130	SK 50	AD	40	130	70	-	-	27	41	6,20	
503.10.40.130	SK 50	AD/B	40	130	70	-	-	27	41	6,16	
502.10.40.160	SK 50	AD	40	160	70	-	-	27	41	7,07	
503.10.40.160	SK 50	AD/B	40	160	70	-	-	27	41	7,03	
503.10.40.200	SK 50	AD/B	40	200	70	-	-	27	41	8,20	

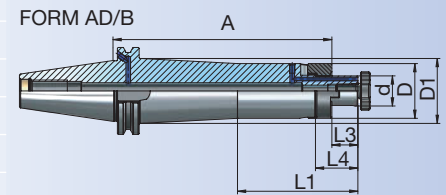
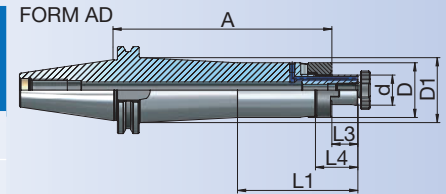

### Zubehör / Accessories / Accessoires / Yedekler

DIN 6366



10.46

Mitnehmerringe  
Clutch drive rings to  
Bague d'entraînement  
Tırnaklı pul

DIN 6367



10.45

Fräseranzugsschrauben  
Drawn in bolt  
Vis de serrage  
Alın sıkma civatası

DIN 6885



10.44

Paßfeder  
Drive key  
Ressort de passage  
Kama

DIN 6388



10.46

Spannschlüssel für Aufsteckdorne  
Wrench  
Clé de serrage  
Alın civatası sıkma anahtarı



## Quernut-Aufsteckdorne mit vergrößertem Bunddurchmesser

Shell mill holder for cutters with driving slot

Porte-fraises à surfacer avec diamètre de collerette élargi

Alın kamalı malafa

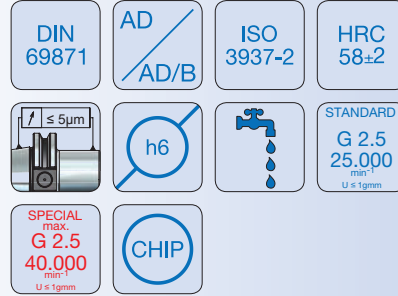

Bestell-Nr. Order Nr. Reference Sipariş Nr.	SK	Form	d	A	D	D1	L1	L3	Kg	Euro
302.11.16.40	SK 30	AD	16	40	38	-	-	17	0,60	
302.11.22.40	SK 30	AD	22	40	45	-	-	19	0,71	
302.11.27.50	SK 30	AD	27	50	60	-	-	21	1,00	
302.11.32.50	SK 30	AD	32	50	78	-	-	24	1,35	
402.11.16.35	SK 40	AD	16	35	38	-	-	17	1,01	
403.11.16.35	SK 40	AD/B	16	35	38	-	-	17	0,98	
402.11.16.100	SK 40	AD	16	100	38	-	-	17	1,59	
403.11.16.100	SK 40	AD/B	16	100	38	-	-	17	1,53	
402.11.16.130	SK 40	AD	16	130	38	-	-	17	1,85	
403.11.16.130	SK 40	AD/B	16	130	38	-	-	17	1,78	
402.11.16.160	SK 40	AD	16	160	38	45,5	88	17	2,24	
403.11.16.160	SK 40	AD/B	16	160	38	45,5	88	17	2,16	
402.11.16.200	SK 40	AD	16	200	38	46,5	120	17	2,62	
<b>new</b> 403.11.16.200	SK 40	AD/B	16	200	38	46,5	120	17	2,60	
402.11.22.35	SK 40	AD	22	35	48	-	-	19	1,13	
403.11.22.35	SK 40	AD/B	22	35	48	-	-	19	1,09	
402.11.22.100	SK 40	AD	22	100	48	-	-	19	2,05	
403.11.22.100	SK 40	AD/B	22	100	48	-	-	19	1,95	
402.11.22.130	SK 40	AD	22	130	48	-	-	19	2,47	
403.11.22.130	SK 40	AD/B	22	130	48	-	-	19	2,34	
402.11.22.160	SK 40	AD	22	160	48	-	-	19	2,89	
403.11.22.160	SK 40	AD/B	22	160	48	-	-	19	2,74	
402.11.22.200	SK 40	AD	22	200	48	-	-	19	3,46	
<b>new</b> 403.11.22.200	SK 40	AD/B	22	200	48	-	-	19	3,40	

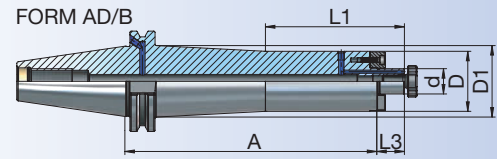
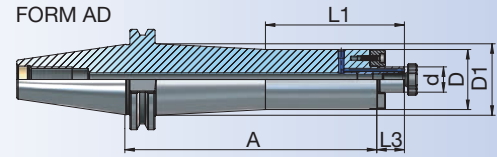

### Zubehör / Accessories / Accessoires / Yedekler

DIN 6367



10.45

Fräseranzugsschrauben  
Drawn in bolt  
Vis de serrage  
Alın sıkma civatası

DIN 6368



10.44

Mitnehmersteine  
Drive keys  
Entraîneur  
Kama

DIN 6368



10.46

Spannschlüssel für Aufsteckdorne  
Wrench  
Clé de serrage  
Alın civatası sıkma anahtarı



## Quernut-Aufsteckdorne mit vergrößertem Bunddurchmesser

Shell mill holder for cutters with driving slot

Porte-fraises à surfacer avec diamètre de colerette élargi

Alın kamalı malafa

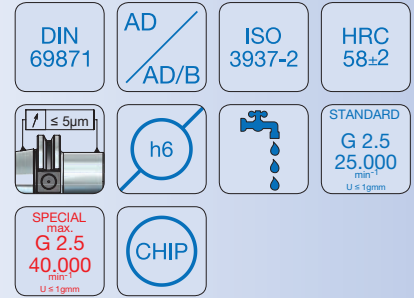

Bestell-Nr. Order Nr. Reference Sipariş Nr.	SK	Form	d	A	D	D1	L1	L3	Kg	Euro
402.11.27.45	SK 40	AD	27	45	60	-	-	21	1,42	
403.11.27.45	SK 40	AD/B	27	45	60	-	-	21	1,37	
402.11.27.100	SK 40	AD	27	100	60	-	-	21	2,64	
403.11.27.100	SK 40	AD/B	27	100	60	-	-	21	2,53	
402.11.27.130	SK 40	AD	27	130	60	-	-	21	3,30	
403.11.27.130	SK 40	AD/B	27	130	60	-	-	21	3,17	
402.11.27.160	SK 40	AD	27	160	60	-	-	21	3,96	
403.11.27.160	SK 40	AD/B	27	160	60	-	-	21	3,80	
402.11.27.200	SK 40	AD	27	200	60	-	-	21	4,84	
<b>new</b> 403.11.27.200	SK 40	AD/B	27	200	60	-	-	21	4,80	
402.11.32.50	SK 40	AD	32	50	78	-	-	24	1,85	
403.11.32.50	SK 40	AD/B	32	50	78	-	-	24	1,79	
402.11.32.100	SK 40	AD	32	100	78	-	-	24	2,84	
403.11.32.100	SK 40	AD/B	32	100	78	-	-	24	2,73	
402.11.32.130	SK 40	AD	32	130	78	-	-	24	3,30	
403.11.32.130	SK 40	AD/B	32	130	78	-	-	24	3,16	
402.11.32.160	SK 40	AD	32	160	78	-	-	24	3,75	
403.11.32.160	SK 40	AD/B	32	160	78	-	-	24	3,59	
402.11.32.200	SK 40	AD	32	200	78	-	-	24	4,36	
<b>new</b> 403.11.32.200	SK 40	AD/B	32	200	78	-	-	24	4,30	
*402.11.40.50	SK 40	AD	40	50	88	-	-	27	2,12	
*403.11.40.50	SK 40	AD/B	40	50	88	-	-	27	2,06	

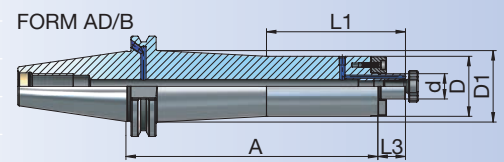
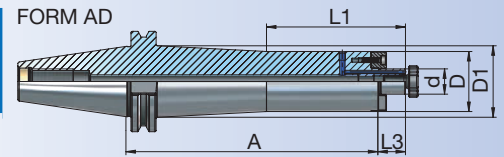

\* d = Ø 40 (M12)

Mit zusätzlichen 4 Gewindebohrungen nach DIN 2079  
With additional 4 screws holes in compliance with DIN 2079  
Avec 4 trous taraudés supplémentaires d'après DIN 2079  
DIN 2079 'a uyun ilave 4 vida baĭlantılı

### Zubehör / Accessories / Accessoires / Yedekler

DIN 6367



10.45

Fräseranzugsschrauben  
Drawn in bolt  
Vis de serrage  
Alın sıkma civatası



10.44

Mitnehmersteine  
Drive keys  
Entraîneur  
Kama

DIN 6368



10.46

Spannschlüssel für Aufsteckdorne  
Wrench  
Clé de serrage  
Alın civatası sıkma anahtarı



## Quernut-Aufsteckdorne mit vergrößertem Bunddurchmesser

Shell mill holder for cutters with driving slot

Porte-fraises à surfacer avec diamètre de collerette élargi

Alın kamalı malafa

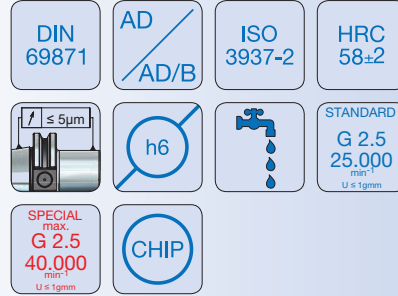

Bestell-Nr. Order Nr. Reference Sipariş Nr.	SK	Form	d	A	D	D1	L1	L3	Kg	Euro
502.11.16.35	SK 50	AD	16	35	38	-	-	17	2,84	
503.11.16.35	SK 50	AD/B	16	35	38	-	-	17	2,79	
502.11.16.100	SK 50	AD	16	100	38	-	-	17	3,41	
503.11.16.100	SK 50	AD/B	16	100	38	-	-	17	3,34	
502.11.16.130	SK 50	AD	16	130	38	-	-	17	3,69	
503.11.16.130	SK 50	AD/B	16	130	38	-	-	17	3,61	
502.11.16.160	SK 50	AD	16	160	38	44,5	88	17	4,09	
503.11.16.160	SK 50	AD/B	16	160	38	44,5	88	17	3,99	
502.11.16.200	SK 50	AD	16	200	38	45	120	17	4,50	
<b>new</b> 503.11.16.200	SK 50	AD/B	16	200	38	45	120	17	4,45	
502.11.22.35	SK 50	AD	22	35	48	-	-	19	2,96	
503.11.22.35	SK 50	AD/B	22	35	48	-	-	19	2,90	
502.11.22.100	SK 50	AD	22	100	48	-	-	19	3,88	
503.11.22.100	SK 50	AD/B	22	100	48	-	-	19	3,76	
502.11.22.130	SK 50	AD	22	130	48	-	-	19	4,32	
503.11.22.130	SK 50	AD/B	22	130	48	-	-	19	4,17	
502.11.22.160	SK 50	AD	22	160	48	55	88	19	4,91	
503.11.22.160	SK 50	AD/B	22	160	48	55	88	19	4,74	
502.11.22.200	SK 50	AD	22	200	48	55,5	120	19	5,52	
<b>new</b> 503.11.22.200	SK 50	AD/B	22	200	48	55,5	120	19	5,48	
502.11.27.40	SK 50	AD	27	40	60	-	-	21	3,26	
503.11.27.40	SK 50	AD/B	27	40	60	-	-	21	3,19	
502.11.27.100	SK 50	AD	27	100	60	-	-	21	4,58	
503.11.27.100	SK 50	AD/B	27	100	60	-	-	21	4,46	
502.11.27.130	SK 50	AD	27	130	60	-	-	21	5,24	
503.11.27.130	SK 50	AD/B	27	130	60	-	-	21	5,09	
502.11.27.160	SK 50	AD	27	160	60	67,5	88	21	6,12	
503.11.27.160	SK 50	AD/B	27	160	60	67,5	88	21	5,95	
502.11.27.200	SK 50	AD	27	200	60	68,5	120	21	7,05	
<b>new</b> 503.11.27.200	SK 50	AD/B	27	200	60	68,5	120	21	7,00	

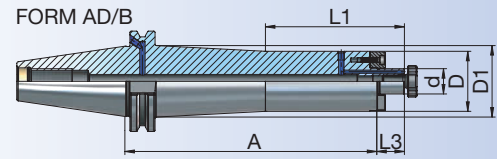
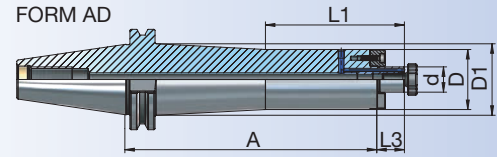

### Zubehör / Accessories / Accessoires / Yedekler



Fräseranzugsschrauben  
Drawn in bolt  
Vis de serrage  
Alın sıkma civatası



Mitnehmersteine  
Drive keys  
Entraîneur  
Kama



Spannschlüssel für Aufsteckdorne  
Wrench  
Clé de serrage  
Alın civatası sıkma anahtarı



## Quernut-Aufsteckdorne mit vergrößertem Bunddurchmesser

Shell mill holder for cutters with driving slot

Porte-fraises à surfacer avec diamètre de colerette élargi

Alın kamalı malafa

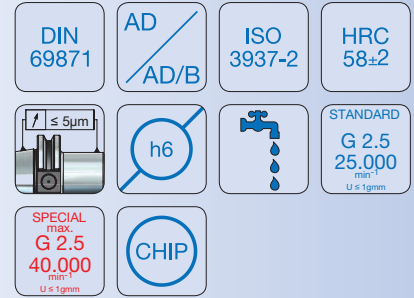

Bestell-Nr. Order Nr. Reference Sipariş Nr.	SK	Form	d	A	D	D1	L1	L3	Kg	Euro
502.11.32.50	SK 50	AD	32	50	78	-	-	24	4,02	
503.11.32.50	SK 50	AD/B	32	50	78	-	-	24	3,93	
502.11.32.100	SK 50	AD	32	100	78	-	-	24	5,88	
503.11.32.100	SK 50	AD/B	32	100	78	-	-	24	5,75	
502.11.32.130	SK 50	AD	32	130	78	-	-	24	7,00	
503.11.32.130	SK 50	AD/B	32	130	78	-	-	24	6,84	
502.11.32.160	SK 50	AD	32	160	78	-	-	24	8,12	
503.11.32.160	SK 50	AD/B	32	160	78	-	-	24	7,93	
502.11.32.200	SK 50	AD	32	200	78	-	-	24	9,61	
<b>new</b> 503.11.32.200	SK 50	AD/B	32	200	78	-	-	24	9,58	
*502.11.40.50	SK 50	AD	40	50	88	-	-	27	4,28	
*503.11.40.50	SK 50	AD/B	40	50	88	-	-	27	4,19	
*502.11.40.100	SK 50	AD	40	100	88	-	-	27	6,65	
*503.11.40.100	SK 50	AD/B	40	100	88	-	-	27	6,52	
*502.11.40.130	SK 50	AD	40	130	88	-	-	27	8,08	
*503.11.40.130	SK 50	AD/B	40	130	88	-	-	27	7,91	
*502.11.40.160	SK 50	AD	40	160	88	-	-	27	9,50	
*503.11.40.160	SK 50	AD/B	40	160	88	-	-	27	9,31	
*502.11.40.200	SK 50	AD	40	200	88	-	-	27	11,40	
<b>new</b> *503.11.40.200	SK 50	AD/B	40	200	88	-	-	27	11,35	
<b>new</b> 502.11.50.70	SK 50	AD	50	70	118	-	-	30	6,84	
503.11.50.70	SK 50	AD/B	50	70	118	-	-	30	6,81	
*502.11.60.70	SK 50	AD	60	70	128	-	-	40	7,63	
*503.11.60.70	SK 50	AD/B	60	70	128	-	-	40	7,50	

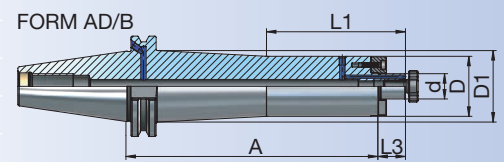
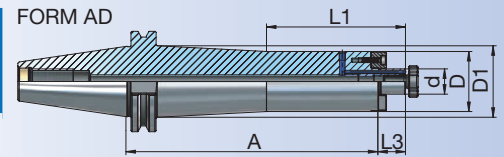

\* d=∅ 40 (M12) \* d=∅ 60 (M16)

Mit zusätzlichen 4 Gewindebohrungen nach DIN 2079  
With additional 4 screws holes in compliance with DIN 2079  
Avec 4 trous taraudés supplémentaires d'après DIN 2079  
DIN 2079 'a uyun ilave 4 vida bağlantılı

### Zubehör / Accessories / Accessoires / Yedekler

DIN 6367



10.45

Fräseranzugsschrauben  
Drawn in bolt  
Vis de serrage  
Alın sıkma civatası



10.44

Mitnehmersteine  
Drive keys  
Entraîneur  
Kama

DIN 6368



10.46

Spannschlüssel für Aufsteckdorne  
Wrench  
Clé de serrage  
Alın civatası sıkma anahtarı



## Fräseraufnahmen für Einschraubfräser

### Milling Cutter Arbors for Screw-on type Milling Cutters

### Axes Coupeur Fraisage Pour Vis-Sur Type Coupeurs de Fraisage

### Vidalı tip frezeler için takım tutucular

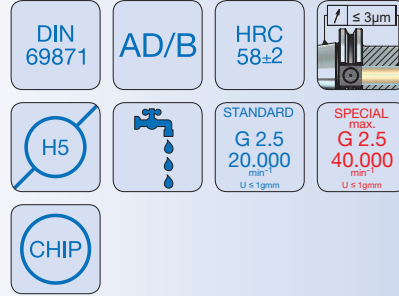

Bestell-Nr. Order Nr. Reference Sipariş Nr.	SK	Form	M	A	d	D	D1	Kg	Euro
403.12.06.44	SK 40	AD/B	M6	44	6,5	10	13	0,80	
403.12.06.69	SK 40	AD/B	M6	69	6,5	10	19,5	0,85	
403.12.06.94	SK 40	AD/B	M6	94	6,5	10	22,5	0,90	
403.12.08.44	SK 40	AD/B	M8	44	8,5	13	15	0,81	
403.12.08.69	SK 40	AD/B	M8	69	8,5	13	22,5	0,87	
403.12.08.94	SK 40	AD/B	M8	94	8,5	13	23	0,92	
403.12.08.119	SK 40	AD/B	M8	119	8,5	13	25	0,99	
403.12.10.24	SK 40	AD/B	M10	24	10,5	18	-	0,81	
403.12.10.44	SK 40	AD/B	M10	44	10,5	18	20	0,83	
403.12.10.69	SK 40	AD/B	M10	69	10,5	18	22,5	0,90	
403.12.10.94	SK 40	AD/B	M10	94	10,5	18	27,5	1,00	
403.12.10.119	SK 40	AD/B	M10	119	10,5	18	32	1,14	
403.12.10.169	SK 40	AD/B	M10	169	10,5	18	36	1,44	
403.12.12.24	SK 40	AD/B	M12	24	12,5	21	-	0,80	
403.12.12.44	SK 40	AD/B	M12	44	12,5	21	24	0,84	
403.12.12.69	SK 40	AD/B	M12	69	12,5	21	24	0,91	
403.12.12.94	SK 40	AD/B	M12	94	12,5	21	31	1,06	
403.12.12.119	SK 40	AD/B	M12	119	12,5	21	33	1,19	
403.12.12.144	SK 40	AD/B	M12	144	12,5	21	35,5	1,37	
403.12.12.169	SK 40	AD/B	M12	169	12,5	21	39,5	1,61	
403.12.16.24	SK 40	AD/B	M16	24	17	29	-	0,78	
403.12.16.44	SK 40	AD/B	M16	44	17	29	-	0,87	
403.12.16.69	SK 40	AD/B	M16	69	17	29	34	1,03	
403.12.16.94	SK 40	AD/B	M16	94	17	29	34	1,18	
403.12.16.119	SK 40	AD/B	M16	119	17	29	36	1,36	
403.12.16.144	SK 40	AD/B	M16	144	17	29	40	1,62	
403.12.16.169	SK 40	AD/B	M16	169	17	29	42,5	1,88	

FORM AD/B

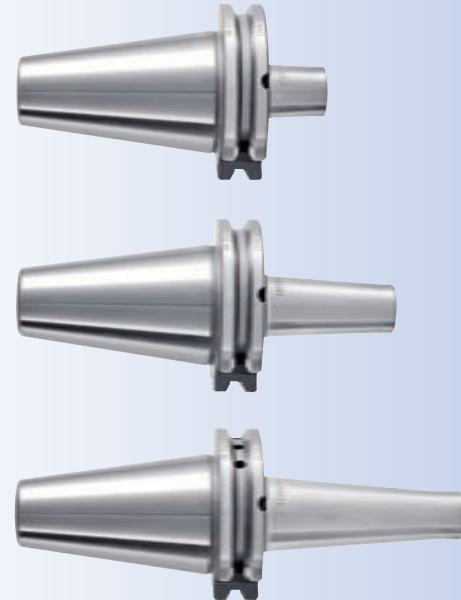
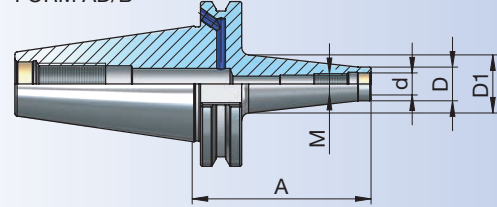

#### Empfohlene Anzugsmomente Recommended tightening torques Torques de serrage recommandés Önerilen sıkma torku

M6	10 Nm
M8	25 Nm
M10	40 Nm
M12	60 Nm
M16	80 Nm

## Zubehör / Accessories / Accessoires / Yedekler



Verlängerungen für Einschraubfräser  
Extensions for milling cutter arbors  
Extension pour vis-sur-type coupeurs de fraisage  
Vidalı tip frezeler için ara adaptör



Reduzierungen für Einschraubfräser  
Reducing for milling cutter arbors  
Extension pour vis-sur-type coupeurs de fraisage  
Vidalı tip frezeler için ara adaptör



## Fräseraufnahmen für Einschraubfräser

### Milling Cutter Arbors for Screw-on type Milling Cutters

### Axes Coupeur Fraisage Pour Vis-Sur Type Coupeurs de Fraisage

### Vidalı tip frezeler için takım tutucular

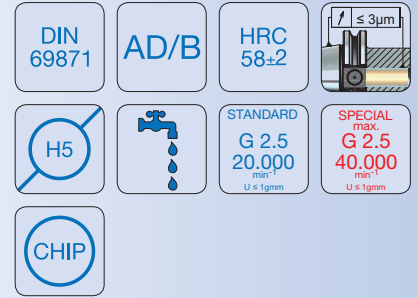

Bestell-Nr. Order Nr. Reference Sipariş Nr.	SK	Form	M	A	d	D	D1	Kg	Euro
503.12.08.69	SK 50	AD/B	M8	69	8,5	13	22,5	2,67	
503.12.08.119	SK 50	AD/B	M8	119	8,5	13	25	2,78	
503.12.08.169	SK 50	AD/B	M8	169	8,5	13	29,5	2,99	
503.12.10.69	SK 50	AD/B	M10	69	10,5	18	23	2,70	
503.12.10.119	SK 50	AD/B	M10	119	10,5	18	32	2,93	
503.12.10.169	SK 50	AD/B	M10	169	10,5	18	36	3,23	
503.12.12.69	SK 50	AD/B	M12	69	12,5	21	24	2,71	
503.12.12.119	SK 50	AD/B	M12	119	12,5	21	33	2,99	
503.12.12.169	SK 50	AD/B	M12	169	12,5	21	39,5	3,39	
503.12.16.69	SK 50	AD/B	M16	69	17	29	34	2,83	
503.12.16.119	SK 50	AD/B	M16	119	17	29	36	3,16	
503.12.16.169	SK 50	AD/B	M16	169	17	29	42,5	3,68	

FORM AD/B

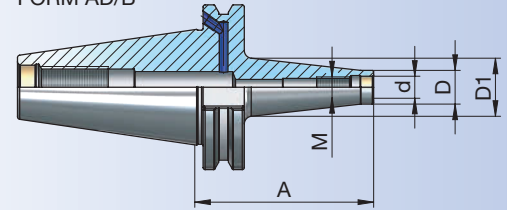

#### Empfohlene Anzugsmomente Recommended tightening torques Torques de serrage recommandés Önerilen sıkma torku

M6	10 Nm
M8	25 Nm
M10	40 Nm
M12	60 Nm
M16	80 Nm

## Zubehör / Accessories / Accessoires / Yedekler



Verlängerungen für Einschraubfräser  
Extensions for milling cutter arbors  
Extension pour vis - sur - type coupeurs de fraisage  
Vidalı tip frezeler için ara adaptör



Reduzierungen für Einschraubfräser  
Reducing for milling cutter arbors  
Extension pour vis - sur - type coupeurs de fraisage  
Vidalı tip frezeler için ara adaptör





## Fräseraufnahmen für Einschraubfräser, schlanke Ausführung

Milling Cutter Arbors for Screw-on type Milling Cutters,  
slimline design

Axes Coupeur Fraisage Pour Vis-Sur Type Coupeurs de Fraisage,  
design mince

Vidalı tip frezeler için takım tutucular, ince cidarlı

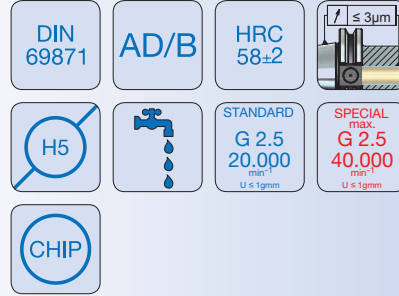

Bestell-Nr. Order Nr. Reference Sipariş Nr.	SK	Form	M	A	d	D	L	Kg	Euro
403.12.10.119.S	SK 40	AD/B	M10	119	10,5	18	100	0,97	
403.12.10.169.S	SK 40	AD/B	M10	169	10,5	18	150	1,05	
403.12.12.119.S	SK 40	AD/B	M12	119	12,5	21	100	1,03	
403.12.12.144.S	SK 40	AD/B	M12	144	12,5	21	125	1,09	
403.12.12.169.S	SK 40	AD/B	M12	169	12,5	21	150	1,15	
403.12.16.119.S	SK 40	AD/B	M16	119	17	29	100	1,24	
403.12.16.144.S	SK 40	AD/B	M16	144	17	29	125	1,36	
403.12.16.169.S	SK 40	AD/B	M16	169	17	29	150	1,48	
503.12.10.119.S	SK 50	AD/B	M10	119	10,5	18	100	2,77	
503.12.10.169.S	SK 50	AD/B	M10	169	10,5	18	150	2,86	
503.12.12.119.S	SK 50	AD/B	M12	119	12,5	21	100	2,83	
503.12.12.169.S	SK 50	AD/B	M12	169	12,5	21	150	2,96	
503.12.16.119.S	SK 50	AD/B	M16	119	17	29	100	3,06	
503.12.16.169.S	SK 50	AD/B	M16	169	17	29	150	3,33	

FORM AD/B

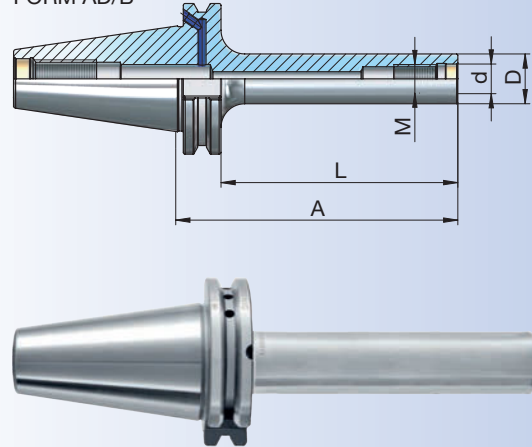

### Empfohlene Anzugsmomente Recommended tightening torques Torques de serrage recommandés Önerilen sıkma torku

M6	10 Nm
M8	25 Nm
M10	40 Nm
M12	60 Nm
M16	80 Nm

## Zubehör / Accessories / Accessoires / Yedekler



Verlängerungen für Einschraubfräser  
Extensions for milling cutter arbors  
Extension pour - sur - type coupeurs de fraisage  
Vidalı tip frezeler için ara adaptör



Reduzierungen für Einschraubfräser  
Reducing for milling cutter arbors  
Extension pour vis - sur - type coupeurs de fraisage  
Vidalı tip frezeler için ara adaptör



## Bohrerhalter für Wendepplattenbohrer E1

Boring holder for drill with indexable insert form E1

Porte foret pour foret à plaquettes réversible forme E1

Takma uçlu drill tutucu E1 Formu

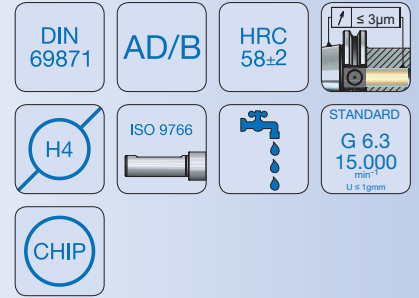

Bestell-Nr. Order Nr. Reference Sipariş Nr.	SK	Form	d	A	D	L2	Kg	Euro
403.51.20.65	SK 40	AD/B	20	65	40	56	1,10	
403.51.25.70	SK 40	AD/B	25	70	45	61,5	1,17	
403.51.32.75	SK 40	AD/B	32	75	52	66,5	1,27	
403.51.40.115	SK 40	AD/B	40	115	63	73	2,32	
503.51.20.70	SK 50	AD/B	20	70	40	54	2,83	
503.51.25.70	SK 50	AD/B	25	70	45	59	2,88	
503.51.32.70	SK 50	AD/B	32	70	52	67,5	2,87	
503.51.40.80	SK 50	AD/B	40	80	63	77	3,07	

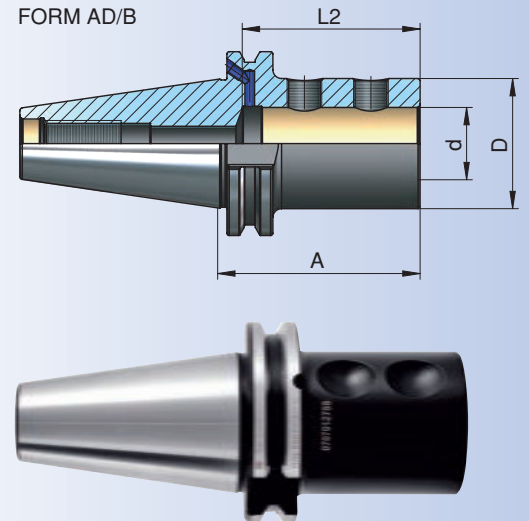

### Zubehör / Accessories / Accessoires / Yedekler

DIN 913



Spannschrauben  
Clamping screw  
Vis de serrage  
Sıkma civatası

10.39 - 10.40

## Bohrfutteraufnahme

Drill chuck adaptor

Arbre pour mandrin de perçage

Mandren malafası



Bestell-Nr. Order Nr. Reference Sipariş Nr.	SK	Form	D1	A	L1	Kg	Euro
302.14.12.40	SK 30	A	B12	40	18,5	0,48	
302.14.16.41	SK 30	A	B16	41	24	0,51	
402.14.12.24	SK 40	A	B12	24	18,5	0,85	
402.14.16.26	SK 40	A	B16	26	24	0,87	
402.14.18.42	SK 40	A	B18	42	32	1,07	
502.14.16.26	SK 50	A	B16	26	24	2,69	
502.14.18.26	SK 50	A	B18	26	32	2,72	

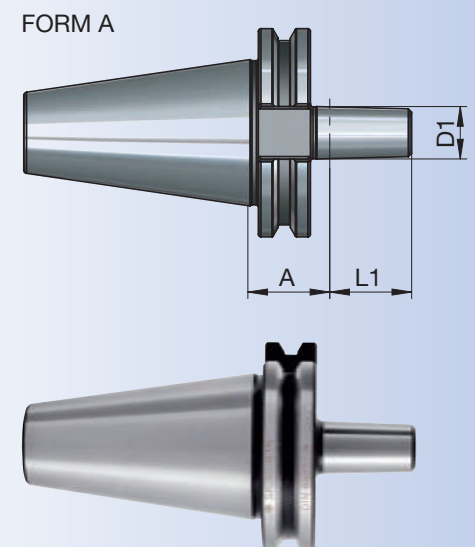

### Zubehör / Accessories / Accessoires / Yedekler



Bohrfutter  
Drill chuck  
Mandrin de perçage à serrage rapide  
Mandren

10.49



## NC - Bohrfutter für Rechts - und Linkslauf

### NC-Drill chucks for left and right rotation

### Mandrin de perçage CNC pour rotation gauche-droite

### NC tipi mandren malafası komple sağ ve sol dönüşlü

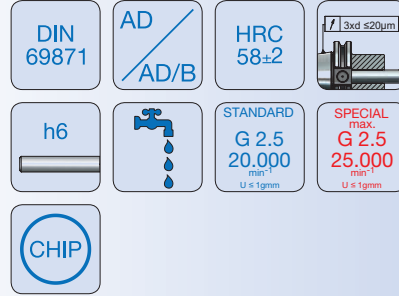

Bestell-Nr. Order Nr. Reference Sipariş Nr.	SK	Form	Spannbereich Capacity Capacité Kapasite	A	D	A1 Max.	Kg	Euro
302.15.08.70	SK 30	AD	0,5 - 8	70	36	73	1,06	
302.15.13.111	SK 30	AD	1,0 - 13	111	50	119	1,51	
402.15.08.70	SK 40	AD	0,5 - 8	70	36	73	1,13	
403.15.08.70	SK 40	AD/B	0,5 - 8	70	36	73	1,17	
402.15.13.90	SK 40	AD	1,0 - 13	90	50	98	1,65	
403.15.13.90	SK 40	AD/B	1,0 - 13	90	50	98	1,61	
402.15.16.95	SK 40	AD	3,0 - 16	95	57	100	1,88	
403.15.16.95	SK 40	AD/B	3,0 - 16	95	57	100	1,84	
502.15.13.90	SK 50	AD	1,0 - 13	90	50	98	3,43	
503.15.13.90	SK 50	AD/B	1,0 - 13	90	50	98	3,47	
502.15.16.95	SK 50	AD	3,0 - 16	95	57	100	3,68	
503.15.16.95	SK 50	AD/B	3,0 - 16	95	57	100	3,71	

FORM AD

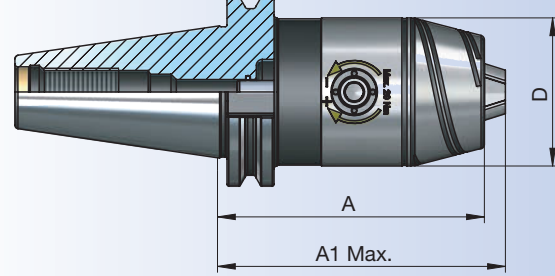

FORM AD/B

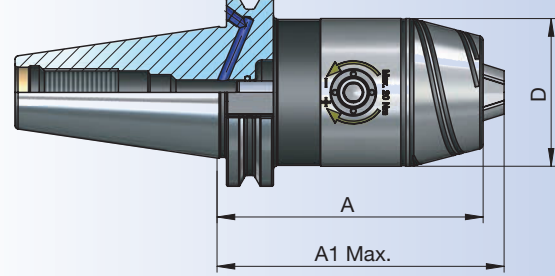

### Zubehör / Accessories / Accessoires / Yedekler



10.55-10.57

Ersatzteile  
Spare Parts  
Pièce de rechange  
Yedek parçalar



10.49

Spannschlüssel  
Wrench  
Clé de serrage  
Sıkma anahtarı



11.06



## Gewindeschneid - Schnellwechselfutter mit Längenausgleich auf Druck und Zug

### Quick-change tapping chucks with length compensation

#### Appareil à tarauder avec compensation longitudinale

#### Kılavuz çekme başlığı giriş ve çıkış kompanzeli

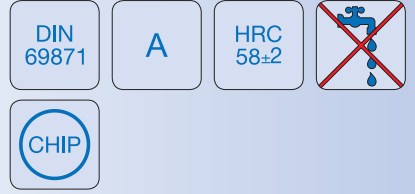

Bestell-Nr. Order Nr. Reference Sipariş Nr.	SK	Form	Spannbereich Capacity Capacité Kapasite	d	A	D	C	T	Kg	Euro
302.16.12.66	SK 30	A	M2-M14	19	66	36,5	7	7	0,58	
302.16.20.99	SK 30	A	M5-M24	31	99	53,5	12	12	1,25	
402.16.12.64	SK 40	A	M2-M14	19	64	36,5	7	7	1,01	
402.16.20.97	SK 40	A	M5-M24	31	97	53,5	12	12	1,66	
402.16.36.136	SK 40	A	M14-M36	48	136	78	17,5	17,5	3,01	
502.16.12.62	SK 50	A	M2-M14	19	62	36,5	7	7	2,76	
502.16.20.85	SK 50	A	M5-M24	31	85	53,5	12	12	3,21	
502.16.36.138	SK 50	A	M14-M36	48	138	78	17,5	17,5	5,21	

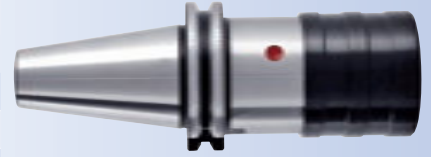
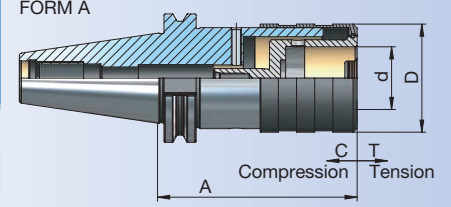

Ausführung : Mit Kugelführungsbuchse

Version : With ball retainer

Version : Comprenant douille de glissière à bille

Teknik özelliği : Bilya Kafesli

## Gewindeschneid - Schnellwechselfutter ohne Längenausgleich auf Druck und Zug

### Quick-change tapping chucks without length compensation

#### Appareil à tarauder sans compensation longitudinale

#### Kılavuz çekme başlığı sabit

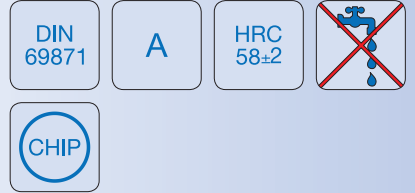

Bestell-Nr. Order Nr. Reference Sipariş Nr.	SK	Form	Spannbereich Capacity Capacité Kapasite	d	A	D	Kg	Euro
302.16.12.1.65	SK 30	A	M2-M14	19	65	38	0,77	
302.16.20.1.93	SK 30	A	M5-M24	31	93	52	1,14	
402.16.12.1.62	SK 40	A	M2-M14	19	62	38	1,02	
402.16.20.1.95	SK 40	A	M5-M24	31	95	52	1,56	
402.16.36.1.137	SK 40	A	M14-M36	48	137	78	3,01	
502.16.12.1.60	SK 50	A	M2-M14	19	60	38	2,82	
502.16.20.1.85	SK 50	A	M5-M24	31	85	52	3,19	
502.16.36.1.117	SK 50	A	M14-M36	48	117	78	4,69	

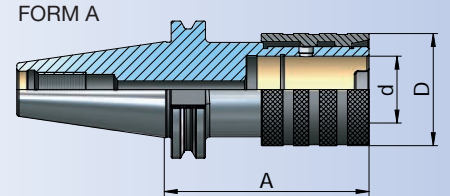

### Zubehör / Accessories / Accessoires / Yedekler



10.34 - 10.36

Schnellwechseleinsätze  
Tapping collets  
Douilles de taraudage  
Kılavuz tutucu



## Rohlinge zur Anfertigung von Sonderwerkzeugen

Boring bar blanks for the production of special tools

Barre d'alésage pour la fabrication d'outils spéciaux

Özel takım yapma amaçlı yarı mamul

DIN  
69871

A

HRC  
52±2



Bestell-Nr. Order Nr. Reference Sipariş Nr.	SK	Form	D	A	Kg	Euro
402.17.63.250	SK 40	A	63	250	6,29	
502.17.97.315	SK 50	A	97	315	19,40	

FORM A

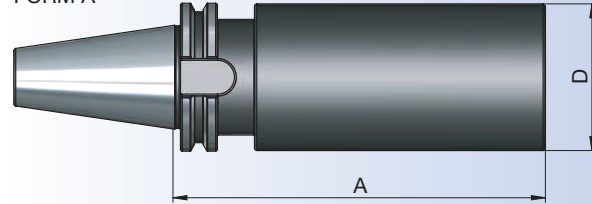

Ausführung : Steilkegel und Bund gehärtet ( $52\pm 2$  HRC) und geschliffen, Schaft weich zur weiteren Bearbeitung.

Version : Cone and flange hardened ( $52\pm 2$  HRC) and grinded. Soft body for later processing.

Version : Cône et collerette durcir ( $52\pm 2$  HRC) et rectifiés. Corps doux pour un usinage ultérieur.

Teknik özelliği : Konik ve Flanş kısmı sertleştirilmiş ( $52\pm 2$  HRC) ve taşlanmıştır. Bara kısmı işlenebilir yumuşaklıktadır.

## Kontrolldorne

Test arbors

Mandrins de contrôle

Fener mili kontrol mastarı

DIN  
69871

A

HRC  
58±2



Bestell-Nr. Order Nr. Reference Sipariş Nr.	SK	Form	D	A	Kg	Euro
302.18.32.200	SK 30	A	32	200	1,41	
402.18.40.300	SK 40	A	40	300	3,39	
502.18.50.300	SK 50	A	50	300	6,33	

FORM A

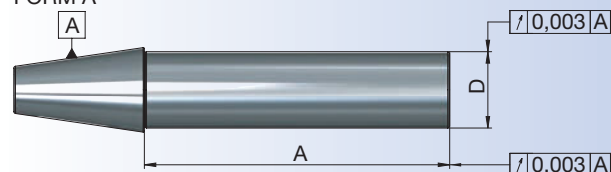

Verwendung : Zur Abnahme von Werkzeugmaschinen gemäß ISO-Empfehlung R230

Application : For acceptance tests of machine tools in accordance with ISO-recommendation R230

Application : Pour la recette technique des machines conforme recommandation ISO R230

Açıklama : Tezgahları devreye alırken ISO Normu R230 sisteminde uygunluğunu kontrol etmek için



## Schrumpffutter zum Spannen von HM Werkzeugschäften

Shrink chuck for mounting of solid carbide cutters

Mandrin de frettage pour le serrage des queue d'outils carbure

İsıtmalı takım tutucular şaftı karbür olan takımlar için

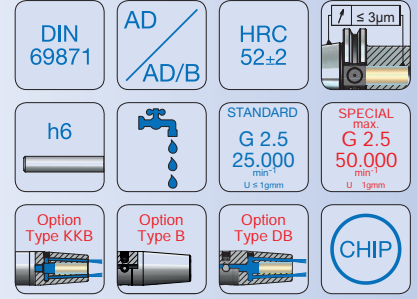

Bestell-Nr. Order Nr. Reference Sipariş Nr.	SK	Form	d	A	D	D1	L2	Kg	Euro
302.25.03.80	SK 30	AD	3	80	10	16	14	0,44	
302.25.04.80	SK 30	AD	4	80	12	20	17	0,47	
302.25.05.80	SK 30	AD	5	80	12	21,5	20	0,47	
302.25.06.80	SK 30	AD	6	80	21	27	36	0,59	
302.25.08.80	SK 30	AD	8	80	21	27	36	0,58	
302.25.10.80	SK 30	AD	10	80	24	32	42	0,65	
302.25.12.80	SK 30	AD	12	80	24	32	47	0,63	
302.25.14.80	SK 30	AD	14	80	27	34	47	0,68	
302.25.16.80	SK 30	AD	16	80	27	34	50	0,66	
302.25.18.80	SK 30	AD	18	80	33	42	50	0,80	
302.25.20.80	SK 30	AD	20	80	33	42	52	0,76	

403.25.03.80	SK 40	AD/B	3	80	10	16	14	0,85	
*403.25.03.120	SK 40	AD/B	3	120	10	16	14	0,91	
*403.25.03.160	SK 40	AD/B	3	160	10	16	14	0,97	
<b>new</b> *403.25.03.200	SK 40	AD/B	3	200	10	16	14	1,03	
403.25.04.80	SK 40	AD/B	4	80	12	20	17	0,88	
*403.25.04.120	SK 40	AD/B	4	120	12	20	17	0,98	
*403.25.04.160	SK 40	AD/B	4	160	12	20	17	1,07	
<b>new</b> *403.25.04.200	SK 40	AD/B	4	200	12	20	17	1,17	
403.25.05.80	SK 40	AD/B	5	80	12	21,5	20	0,89	
*403.25.05.120	SK 40	AD/B	5	120	12	22	20	1,00	
*403.25.05.160	SK 40	AD/B	5	160	12	22	20	1,11	
<b>new</b> *403.25.05.200	SK 40	AD/B	5	200	12	22	20	1,22	
403.25.06.80	SK 40	AD/B	6	80	21	27	36	1,03	
403.25.06.120	SK 40	AD/B	6	120	21	27	36	1,19	
403.25.06.160	SK 40	AD/B	6	160	21	27	36	1,35	
<b>new</b> 403.25.06.200	SK 40	AD/B	6	200	21	27	36	1,52	
403.25.08.80	SK 40	AD/B	8	80	21	27	36	1,02	
403.25.08.120	SK 40	AD/B	8	120	21	27	36	1,18	
403.25.08.160	SK 40	AD/B	8	160	21	27	36	1,35	
<b>new</b> 403.25.08.200	SK 40	AD/B	8	200	21	27	36	1,53	

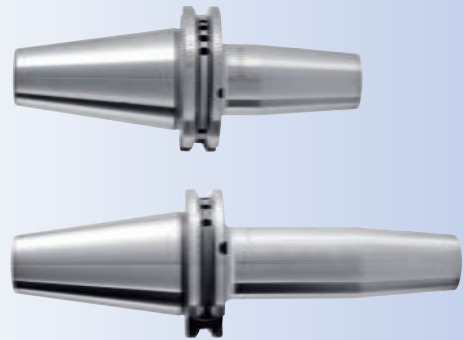
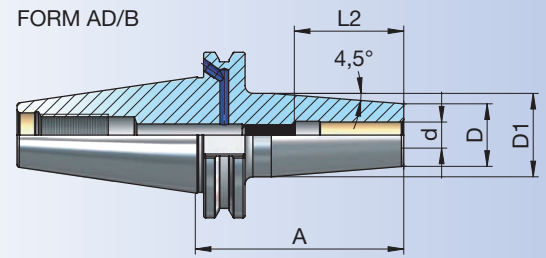
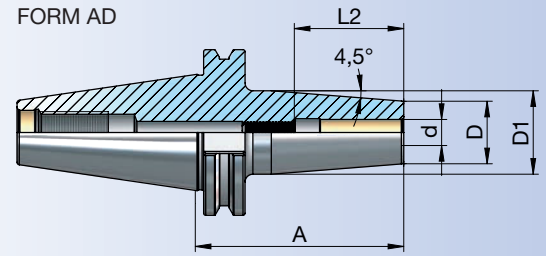

\* Einstellschraube nicht enthalten  
\* Does not include adjusting screw  
\* Ne comprend pas la vis de réglage  
\* Dayama civatası içermez

### Zubehör / Accessories / Accessoires / Yedekler

DIN 916



10.41-10.43

Einstellschraube  
Adjusting screw  
Vis de réglage  
Dayama civatası



11.08

## Schrumpffutter zum Spannen von HM Werkzeugschäften

Shrink chuck for mounting of solid carbide cutters

Mandrin de frettage pour le serrage des queue d'outils carbure

Isıtmalı takım tutucular şaftı karbür olan takımlar için



DIN ISO 7388-1  
(SK DIN 69871)

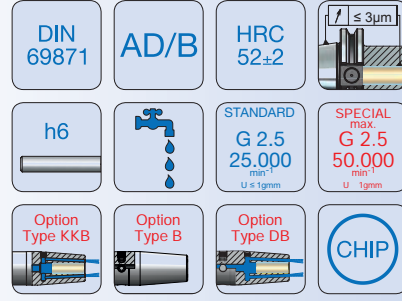

Bestell-Nr. Order Nr. Reference Sipariş Nr.	SK	Form	d	A	D	D1	L2	Kg	Euro
403.25.10.80	SK 40	AD/B	10	80	24	32	42	1,09	
403.25.10.120	SK 40	AD/B	10	120	24	32	42	1,32	
403.25.10.160	SK 40	AD/B	10	160	24	32	42	1,56	
<b>new</b> 403.25.10.200	SK 40	AD/B	10	200	24	32	42	1,80	
403.25.12.80	SK 40	AD/B	12	80	24	32	47	1,06	
403.25.12.120	SK 40	AD/B	12	120	24	32	47	1,27	
403.25.12.160	SK 40	AD/B	12	160	24	32	47	1,49	
<b>new</b> 403.25.12.200	SK 40	AD/B	12	200	24	32	47	1,71	
403.25.14.80	SK 40	AD/B	14	80	27	34	47	1,10	
403.25.14.120	SK 40	AD/B	14	120	27	34	47	1,35	
403.25.14.160	SK 40	AD/B	14	160	27	34	47	1,60	
<b>new</b> 403.25.14.200	SK 40	AD/B	14	200	27	34	47	1,86	
403.25.16.80	SK 40	AD/B	16	80	27	34	50	1,08	
403.25.16.120	SK 40	AD/B	16	120	27	34	50	1,33	
403.25.16.160	SK 40	AD/B	16	160	27	34	50	1,58	
<b>new</b> 403.25.16.200	SK 40	AD/B	16	200	27	34	50	1,84	
403.25.18.80	SK 40	AD/B	18	80	33	42	50	1,23	
403.25.18.120	SK 40	AD/B	18	120	33	42	50	1,62	
403.25.18.160	SK 40	AD/B	18	160	33	42	50	2,02	
<b>new</b> 403.25.18.200	SK 40	AD/B	18	200	33	42	50	2,42	
403.25.20.80	SK 40	AD/B	20	80	33	42	52	1,20	
403.25.20.120	SK 40	AD/B	20	120	33	42	52	1,60	
403.25.20.160	SK 40	AD/B	20	160	33	42	52	1,99	
<b>new</b> 403.25.20.200	SK 40	AD/B	20	200	33	42	52	2,38	
403.25.25.100	SK 40	AD/B	25	100	44	53	58	1,75	
403.25.25.120	SK 40	AD/B	25	120	44	53	58	2,08	
403.25.25.160	SK 40	AD/B	25	160	44	53	58	2,73	
<b>new</b> 403.25.25.200	SK 40	AD/B	25	200	44	53	58	3,38	
403.25.32.100	SK 40	AD/B	32	100	44	53	62	1,59	
403.25.32.120	SK 40	AD/B	32	120	44	53	62	1,92	
403.25.32.160	SK 40	AD/B	32	160	44	53	62	2,57	
<b>new</b> 403.25.32.200	SK 40	AD/B	32	200	44	53	62	3,20	

FORM AD/B

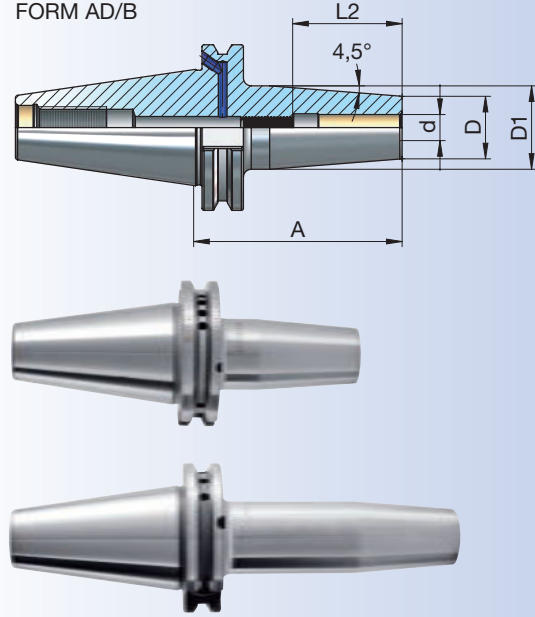

### Zubehör / Accessories / Accessoires / Yedekler

DIN 916



Einsteilschraube  
Adjusting screw  
Vis de réglage  
Dayama civatası

10.41-10.43



11.08



## Schrumpffutter zum Spannen von HM Werkzeugschäften

Shrink chuck for mounting of solid carbide cutters

Mandrin de frettage pour le serrage des queue d'outils carbure

İsıtmalı takım tutucular şaftı karbür olan takımlar için

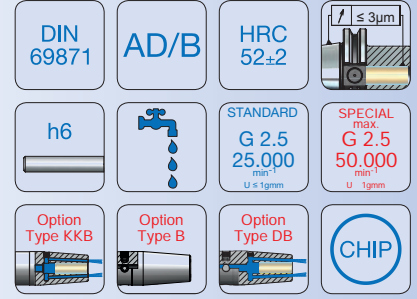

Bestell-Nr. Order Nr. Reference Sipariş Nr.	SK	Form	d	A	D	D1	L2	Kg	Euro
503.25.03.80	SK 50	AD/B	3	80	10	16	14	2,66	
*503.25.03.120	SK 50	AD/B	3	120	10	16	14	2,72	
*503.25.03.160	SK 50	AD/B	3	160	10	16	14	2,77	
<b>new</b> *503.25.03.200	SK 50	AD/B	3	200	10	16	14	2,83	
503.25.04.80	SK 50	AD/B	4	80	12	20	17	2,69	
*503.25.04.120	SK 50	AD/B	4	120	12	20	17	2,78	
*503.25.04.160	SK 50	AD/B	4	160	12	20	17	2,88	
<b>new</b> *503.25.04.200	SK 50	AD/B	4	200	12	20	17	2,97	
503.25.05.80	SK 50	AD/B	5	80	12	21,5	20	2,69	
*503.25.05.120	SK 50	AD/B	5	120	12	22	20	2,80	
*503.25.05.160	SK 50	AD/B	5	160	12	22	20	2,91	
<b>new</b> *503.25.05.200	SK 50	AD/B	5	200	12	22	20	3,02	
503.25.06.80	SK 50	AD/B	6	80	21	27	36	2,84	
503.25.06.120	SK 50	AD/B	6	120	21	27	36	3,00	
503.25.06.160	SK 50	AD/B	6	160	21	27	36	3,16	
<b>new</b> 503.25.06.200	SK 50	AD/B	6	200	21	27	36	3,33	
503.25.08.80	SK 50	AD/B	8	80	21	27	36	2,83	
503.25.08.120	SK 50	AD/B	8	120	21	27	36	2,99	
503.25.08.160	SK 50	AD/B	8	160	21	27	36	3,16	
<b>new</b> 503.25.08.200	SK 50	AD/B	8	200	21	27	36	3,32	
503.25.10.80	SK 50	AD/B	10	80	24	32	42	2,89	
503.25.10.120	SK 50	AD/B	10	120	24	32	42	3,13	
503.25.10.160	SK 50	AD/B	10	160	24	32	42	3,36	
<b>new</b> 503.25.10.200	SK 50	AD/B	10	200	24	32	42	3,59	
503.25.12.80	SK 50	AD/B	12	80	24	32	47	2,86	
503.25.12.120	SK 50	AD/B	12	120	24	32	47	3,07	
503.25.12.160	SK 50	AD/B	12	160	24	32	47	3,29	
<b>new</b> 503.25.12.200	SK 50	AD/B	12	200	24	32	47	3,51	

FORM AD/B

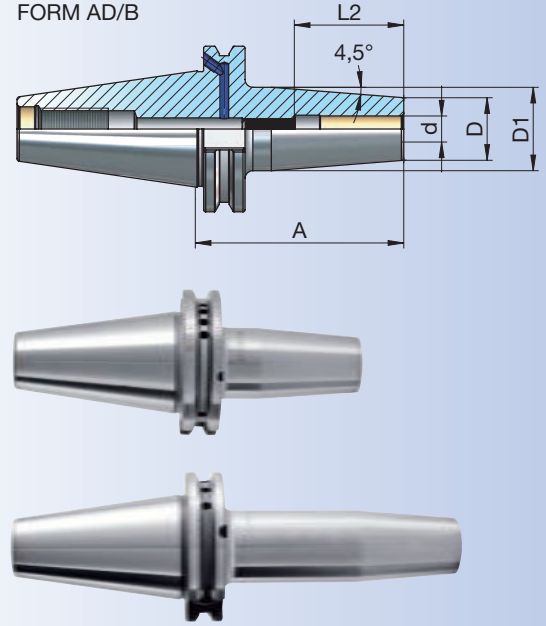

\* Einstellschraube nicht enthalten  
\* Does not include adjusting screw  
\* Ne comprend pas la vis de réglage  
\* Dayama civatası içermez

### Zubehör / Accessories / Accessoires / Yedekler

DIN 916



10.41-10.43

Einstellschraube  
Adjusting screw  
Vis de réglage  
Dayama civatası



11.08





## Schrumpffutter zum Spannen von HM Werkzeugschäften

Shrink chuck for mounting of solid carbide cutters

Mandrin de frettage pour le serrage des queue d'outils carbure

Isıtmalı takım tutucular şaftı karbür olan takımlar için

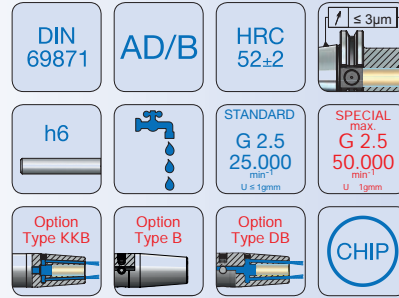

Bestell-Nr. Order Nr. Reference Sipariş Nr.	SK	Form	d	A	D	D1	L2	Kg	Euro
503.25.14.80	SK 50	AD/B	14	80	27	34	47	2,91	
503.25.14.120	SK 50	AD/B	14	120	27	34	47	3,15	
503.25.14.160	SK 50	AD/B	14	160	27	34	47	3,40	
<b>new</b> 503.25.14.200	SK 50	AD/B	14	200	27	34	47	3,64	
503.25.16.80	SK 50	AD/B	16	80	27	34	50	2,89	
503.25.16.120	SK 50	AD/B	16	120	27	34	50	3,13	
503.25.16.160	SK 50	AD/B	16	160	27	34	50	3,38	
<b>new</b> 503.25.16.200	SK 50	AD/B	16	200	27	34	50	3,63	
503.25.18.80	SK 50	AD/B	18	80	33	42	50	3,03	
503.25.18.120	SK 50	AD/B	18	120	33	42	50	3,43	
503.25.18.160	SK 50	AD/B	18	160	33	42	50	3,83	
<b>new</b> 503.25.18.200	SK 50	AD/B	18	200	33	42	50	4,24	
503.25.20.80	SK 50	AD/B	20	80	33	42	52	3,00	
503.25.20.120	SK 50	AD/B	20	120	33	42	52	3,40	
503.25.20.160	SK 50	AD/B	20	160	33	42	52	3,80	
<b>new</b> 503.25.20.200	SK 50	AD/B	20	200	33	42	52	4,22	
503.25.25.100	SK 50	AD/B	25	100	44	53	58	3,59	
503.25.25.120	SK 50	AD/B	25	120	44	53	58	3,92	
503.25.25.160	SK 50	AD/B	25	160	44	53	58	4,58	
<b>new</b> 503.25.25.200	SK 50	AD/B	25	200	44	53	58	5,26	
503.25.32.100	SK 50	AD/B	32	100	44	53	62	3,43	
503.25.32.120	SK 50	AD/B	32	120	44	53	62	3,76	
503.25.32.160	SK 50	AD/B	32	160	44	53	62	4,41	
<b>new</b> 503.25.32.200	SK 50	AD/B	32	200	44	53	62	5,02	

FORM AD/B

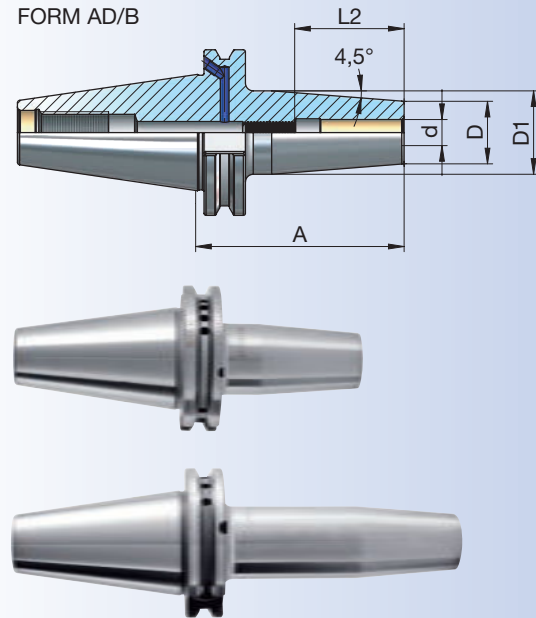

### Zubehör / Accessories / Accessoires / Yedekler

DIN 916



10.41-10.43

Einsteilschraube  
Adjusting screw  
Vis de réglage  
Dayama civatası



11.08



## Schrumpffutter - schlanke Ausführung für HM Werkzeugschäften

Shrink chucks - slimline design for solid carbide cutters

Mandrins de frettage - design mince four queue d'outils carbure

İnce cidarlı ısıtılmalı takım tutucular şaftı karbür olan takımlar için

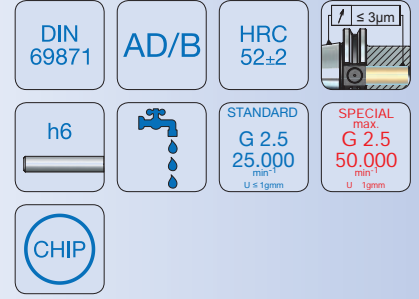

Bestell-Nr. Order Nr. Reference Sipariş Nr.	SK	Form	d	A	D	D1	L2	Kg	Euro
403.25.03.80.S	SK 40	AD/B	3	80	9	14	14	0,84	
*403.25.03.120.S	SK 40	AD/B	3	120	9	18	14	0,91	
403.25.04.80.S	SK 40	AD/B	4	80	10	15	17	0,84	
*403.25.04.120.S	SK 40	AD/B	4	120	10	19	17	0,92	
403.25.05.80.S	SK 40	AD/B	5	80	11	16	20	0,85	
*403.25.05.120.S	SK 40	AD/B	5	120	11	20	20	0,94	
403.25.06.80.S	SK 40	AD/B	6	80	12	17	36	0,88	
403.25.06.120.S	SK 40	AD/B	6	120	12	21	36	0,97	
403.25.06.160.S	SK 40	AD/B	6	160	12	25	36	1,10	
403.25.08.80.S	SK 40	AD/B	8	80	14	19	36	0,90	
403.25.08.120.S	SK 40	AD/B	8	120	14	23	36	1,00	
403.25.08.160.S	SK 40	AD/B	8	160	14	27	36	1,16	
403.25.10.80.S	SK 40	AD/B	10	80	16	21	42	0,91	
403.25.10.120.S	SK 40	AD/B	10	120	16	25	42	1,04	
403.25.10.160.S	SK 40	AD/B	10	160	16	29	42	1,23	
403.25.12.80.S	SK 40	AD/B	12	80	18	23	47	0,91	
403.25.12.120.S	SK 40	AD/B	12	120	18	27	47	1,05	
403.25.12.160.S	SK 40	AD/B	12	160	18	31	47	1,24	

503.25.03.80.S	SK 50	AD/B	3	80	9	14	14	2,64	
*503.25.03.120.S	SK 50	AD/B	3	120	9	18	14	2,71	
503.25.04.80.S	SK 50	AD/B	4	80	10	15	17	2,65	
*503.25.04.120.S	SK 50	AD/B	4	120	10	19	17	2,73	
503.25.05.80.S	SK 50	AD/B	5	80	11	16	20	2,66	
*503.25.05.120.S	SK 50	AD/B	5	120	11	20	20	2,74	
503.25.06.80.S	SK 50	AD/B	6	80	12	17	36	2,69	
503.25.06.120.S	SK 50	AD/B	6	120	12	21	36	2,77	
503.25.06.160.S	SK 50	AD/B	6	160	12	25	36	2,90	
503.25.08.80.S	SK 50	AD/B	8	80	14	19	36	2,71	
503.25.08.120.S	SK 50	AD/B	8	120	14	23	36	2,81	
503.25.08.160.S	SK 50	AD/B	8	160	14	27	36	2,97	
503.25.10.80.S	SK 50	AD/B	10	80	16	21	42	2,72	
503.25.10.120.S	SK 50	AD/B	10	120	16	25	42	2,85	
503.25.10.160.S	SK 50	AD/B	10	160	16	29	42	3,03	
503.25.12.80.S	SK 50	AD/B	12	80	18	23	47	2,72	
503.25.12.120.S	SK 50	AD/B	12	120	18	27	47	2,85	
503.25.12.160.S	SK 50	AD/B	12	160	18	31	47	3,05	

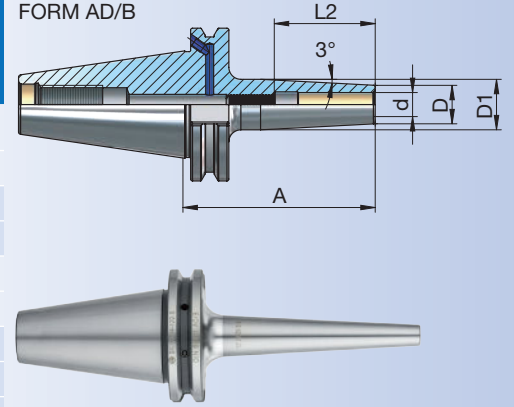

- \* Einstellschraube nicht enthalten
- \* Does not include adjusting screw
- \* Ne comprend pas la vis de réglage
- \* Dayama civatası içermez

## Zubehör / Accessories / Accessoires / Yedekler



Einstellschraube  
Adjusting screw  
Vis de réglage  
Dayama civatası



11.08



## Hydro - Dehnspannfutter

### Hydraulic expansions chuck

### Mandrins expansibles hydrauliques

### Hidrolik takım tutucular

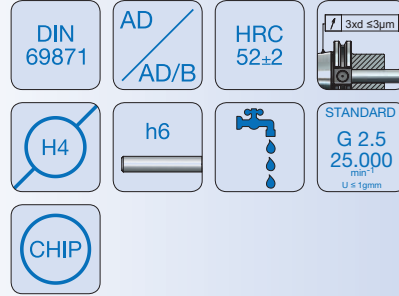

Bestell-Nr. Order Nr. Reference Sipariş Nr.	SK	Form	d	A	D	D1	L1	L2	Kg	Euro
302.65.12.90	SK 30	AD	12	90	32	49,5	36	46	0,90	
302.65.20.100	SK 30	AD	20	100	42	49,5	46	57	1,09	
403.65.06.80	SK 40	AD/B	6	80	26	49,5	40	37	1,16	
403.65.08.80	SK 40	AD/B	8	80	28	49,5	40	37	1,18	
403.65.10.80	SK 40	AD/B	10	80	30	49,5	40	41	1,19	
403.65.12.80	SK 40	AD/B	12	80	32	49,5	40	46	1,21	
403.65.14.80	SK 40	AD/B	14	80	34	49,5	40	46	1,22	
403.65.16.80	SK 40	AD/B	16	80	38	49,5	46	49	1,27	
403.65.18.80	SK 40	AD/B	18	80	40	49,5	46	49	1,27	
403.65.20.80	SK 40	AD/B	20	80	42	49,5	46	57	1,29	
403.65.25.95	SK 40	AD/B	25	95	49,5	55	76	57	1,78	
403.65.32.95	SK 40	AD/B	32	95	56	63	76	57	1,91	
503.65.06.80	SK 50	AD/B	6	80	26	49,5	40	37	2,83	
503.65.08.80	SK 50	AD/B	8	80	28	49,5	40	37	2,93	
503.65.10.80	SK 50	AD/B	10	80	30	49,5	40	41	2,81	
503.65.12.80	SK 50	AD/B	12	80	32	49,5	40	46	2,88	
503.65.14.80	SK 50	AD/B	14	80	34	49,5	40	46	2,88	
503.65.16.80	SK 50	AD/B	16	80	38	49,5	46	49	2,88	
503.65.18.80	SK 50	AD/B	18	80	40	49,5	46	49	2,93	
503.65.20.80	SK 50	AD/B	20	80	42	49,5	46	57	2,98	
503.65.25.100	SK 50	AD/B	25	100	55	60	55	57	3,65	
503.65.32.100	SK 50	AD/B	32	100	63	70	55	57	4,03	

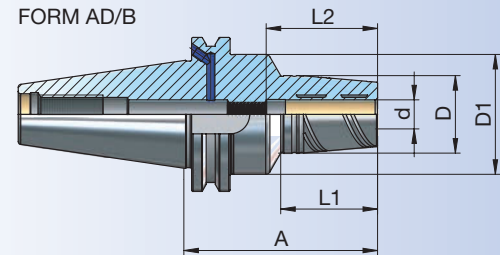
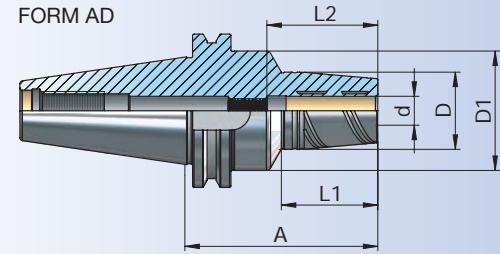

## Zubehör / Accessories / Accessoires / Yedekler



Reduzierungen  
Reducing arbor  
Douille de réduction  
Pens



DIN 916  
Einstellschraube  
Adjusting screw  
Vis de réglage  
Dayama civatası



Spannschlüssel  
Wrench  
Clé de serrage  
Sıkma anahtarı



Büchsenzieher für Reduzierungen  
Sleeve remover for reducing arbor  
Clé étrépage pour douilles  
Hidrolik Takım Pensi Çıkarma Anahtarı



11.10



## Hydro - Dehnspannfutter lange Ausführung

Hydraulic expansions chuck, long

Mandrins expansibles hydrauliques, longue

Hidrolik takım tutucular, uzun

Bestell-Nr. Order Nr. Reference Sipariş Nr.	SK	Form	d	A	D	D1	L1	L2	Kg	Euro
403.65.06.110	SK 40	AD/B	6	110	26	49,5	40	37	1,65	
403.65.08.110	SK 40	AD/B	8	110	28	49,5	40	37	1,64	
403.65.10.110	SK 40	AD/B	10	110	30	49,5	40	41	1,63	
403.65.12.110	SK 40	AD/B	12	110	32	49,5	40	46	1,65	
403.65.14.110	SK 40	AD/B	14	110	34	49,5	40	46	1,63	
403.65.16.110	SK 40	AD/B	16	110	38	49,5	46	49	1,66	
403.65.18.110	SK 40	AD/B	18	110	40	49,5	46	49	1,91	
403.65.20.110	SK 40	AD/B	20	110	42	49,5	46	51	1,70	
403.65.25.110	SK 40	AD/B	25	110	49,5	55	91	57	2,03	
403.65.32.110	SK 40	AD/B	32	110	56	63	91	61	2,24	

503.65.06.110	SK 50	AD/B	6	110	26	49,5	40	37	3,41	
503.65.08.110	SK 50	AD/B	8	110	28	49,5	40	37	3,49	
503.65.10.110	SK 50	AD/B	10	110	30	49,5	40	41	3,56	
503.65.12.110	SK 50	AD/B	12	110	32	49,5	40	46	3,43	
503.65.14.110	SK 50	AD/B	14	110	34	49,5	40	46	3,47	
503.65.16.110	SK 50	AD/B	16	110	38	49,5	46	49	3,40	
503.65.18.110	SK 50	AD/B	18	110	40	49,5	46	49	3,53	
503.65.20.110	SK 50	AD/B	20	110	42	49,5	46	51	3,52	
503.65.25.120	SK 50	AD/B	25	120	55	60	55	57	4,23	
503.65.32.120	SK 50	AD/B	32	120	63	70	55	61	4,83	

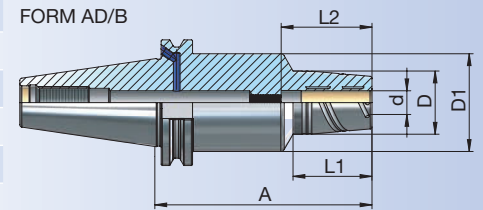
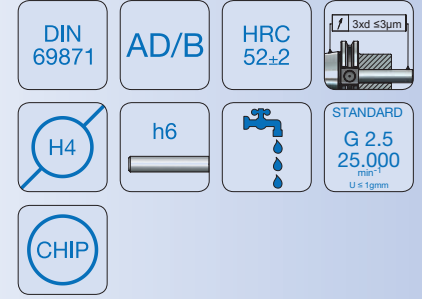

## Hydro - Dehnspannfutter schlanke Ausführung

Hydraulic expansions chuck, slimline design

Mandrins expansibles hydrauliques, design mince

Hidrolik takım tutucular, ince cidarlı

Bestell-Nr. Order Nr. Reference Sipariş Nr.	SK	Form	d	A	D	D1	L1	L2	Kg	Euro
403.65.12.110.S	SK 40	AD/B	12	110	25	49,5	60	46	1,35	
503.65.12.110.S	SK 50	AD/B	12	110	25	49,5	60	46	3,60	

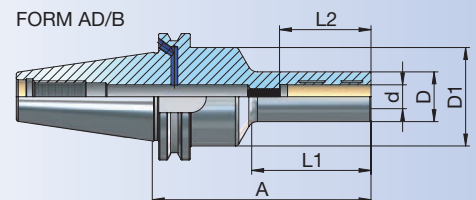
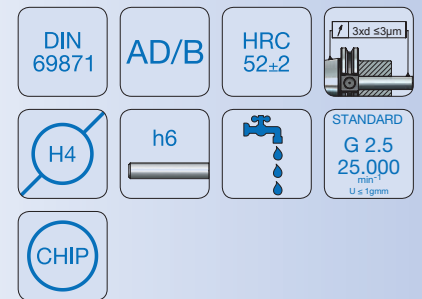

### Zubehör / Accessories / Accessoires / Yedekler



Reduzierungen  
Reducing arbor  
Douille de réduction  
Pens

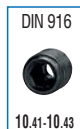

DIN 916  
Einstellschraube  
Adjusting screw  
Vis de réglage  
Dayama civatası



Spannschlüssel  
Wrench  
Clé de serrage  
Sıkma anahtarı



Büchsenzieher für Reduzierungen  
Sleeve remover for reducing arbor  
Clé étréage pour douilles  
Hidrolik Takım Pensi Çıkarma Anahtarı



i

11.10



## Hydro - Dehnspannfutter extra kurze Ausführung

Hydraulic expansions chuck extra, short

Mandrins expansibles hydrauliques extra, court

Hidrolik takım tutucu, ekstra kısa

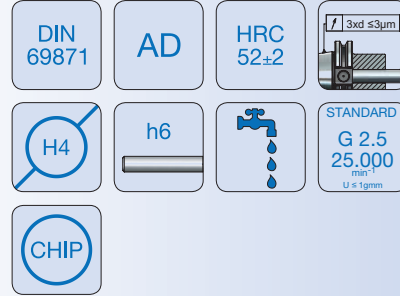

Bestell-Nr. Order Nr. Reference Sipariş Nr.	SK	Form	d	A	D	L2	Kg	Euro
402.65.20.24	SK 40	AD	20	24,6	49,5	51	0,74	

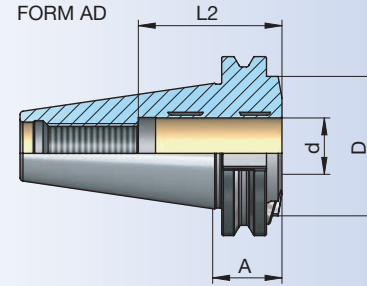

### Zubehör / Accessories / Accessoires / Yedekler



Reduzierungen  
Reducing arbor  
Douille de réduction  
Pens



Spannschlüssel  
Wrench  
Clé de serrage  
Sıkma anahtarı

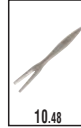

Büchsenzieher für Reduzierungen  
Sleeve remover for reducing arbor  
Clé élargie pour douilles  
Hidrolik Takım Pensi Çıkarma Anahtarı



## Hydro - Dehnspannfutter kurz /schwer

Hydraulic expansions chuck, short heavy

Mandrins expansibles hydrauliques, court lourd

Hidrolik takım tutucu, kısa rijit

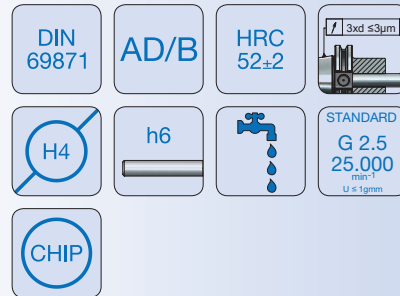

Bestell-Nr. Order Nr. Reference Sipariş Nr.	SK	Form	d	A	D	L2	Kg	Euro
403.65.20.64	SK 40	AD/B	20	64,5	49,5	51	1,27	

503.65.20.64	SK 50	AD/B	20	64,5	49,5	51	2,10	
503.65.32.81	SK 50	AD/B	32	81	72	61	3,95	

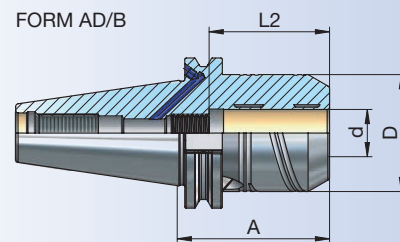

### Zubehör / Accessories / Accessoires / Yedekler



Reduzierungen  
Reducing arbor  
Douille de réduction  
Pens

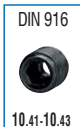

Einstellschraube  
Adjusting screw  
Vis de réglage  
Dayama civatası



Spannschlüssel  
Wrench  
Clé de serrage  
Sıkma anahtarı



Büchsenzieher für Reduzierungen  
Sleeve remover for reducing arbor  
Clé élargie pour douilles  
Hidrolik Takım Pensi Çıkarma Anahtarı





## Hydro-Dehnspannfuttersatz im Koffer

Hydraulic expansion chuck set in box

Mandrin expansibles hydraulique (set) dans coffre

Hidrolik tutucu seti plastik kutuda

DIN  
69871

AD  
AD/B

HRC  
52±2



CHIP

Bestell-Nr. Order Nr. Reference Sipariş Nr.	SK	Form	Spannbereich Capacity Capacité Kapasite	Spannzangen Durchmesser Collet Diameter Pincés Diamètre Pens Çapı	Reduzierhulsen Reducing Réduction Pens Adedi	Kg	Euro
302.66.12.90	SK 30	AD	R12 (3-8)	3-4-5-6-8	5	1,75	
302.66.20.100	SK 30	AD	R20 (6-16)	6-8-10-12-16	5	2,12	
403.66.12.80	SK 40	AD/B	R12 (3-8)	3-4-5-6-8	5	2,06	
403.66.20.80	SK 40	AD/B	R20 (6-16)	6-8-10-12-16	5	2,30	
403.66.20.64	SK 40	AD/B	R20 (6-16)	6-8-10-12-16	5	2,30	
403.66.32.95	SK 40	AD/B	R32 (6-25)	6-8-10-12-16-20-25	7	4,35	
503.66.12.80	SK 50	AD/B	R12 (3-8)	3-4-5-6-8	5	4,14	
503.66.20.64	SK 50	AD/B	R20 (6-16)	6-8-10-12-16	5	2,70	
503.66.20.80	SK 50	AD/B	R20 (6-16)	6-8-10-12-16	5	4,38	
503.66.32.81	SK 50	AD/B	R32 (6-25)	6-8-10-12-16-20-25	7	6,59	
503.66.32.100	SK 50	AD/B	R32 (6-25)	6-8-10-12-16-20-25	7	6,67	

Lieferumfang : Spannfüter, inkl. Spannzangen mit Schlüssel  
Included : Collet chuck with collets and wrench  
Inclus : Mandrin avec pincés et clé  
Teslim Şekli : Takım, pensleri ve anahtarıyla birlikte



### Zubehör / Accessories / Accessoires / Yedekler



Reduzierungen  
Reducing arbor  
Douille de réduction  
Pens

10.20-10.21



Einstellschraube  
Adjusting screw  
Vis de réglage  
Dayama civatası

10.41-10.43



Spannschlüssel  
Wrench  
Clé de serrage  
Sıkma anahtarı

10.49



Büchsenzieher für Reduzierungen  
Sleeve remover for reducing arbor  
Clé étirage pour douilles  
Hidrolik Takım Pensi Çıkarma Anahtarı

10.48



11.10