



# SETLER SETS



Referans Nr.				DIN 6379 d x L
1990-1012	M10x12	265x255	6.44	M10x80-100-160-200
1990-1214	M12x14	305x255	8.72	M12x80-100-160-200
1990-1416	M14x16	435-255	12.98	M14x80-100-160-200
1990-1618	M16x18	435-255	16.30	M16x80-100-160-200
1990-1820	M18x20	495x255	17.82	M18x80-100-160-200
1990-2022	M20x22	540x255	23.10	M20x100-125-160-200



**Ürün Nr. 1990 Vidalı Yükselticili Bağlama Set**





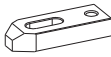

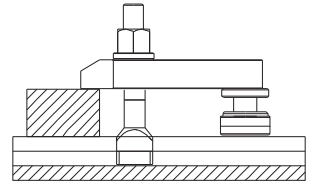
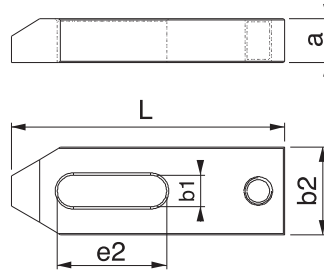
- Tabla üzerine iş parçası ve aparatların hızlı ve güvenli bir şekilde bağlanması için çelik mamülden üretilmiş parçalardan oluşan bağlama seti

**Product Nr. 1990 Screwed Coupling Set with Lifter**

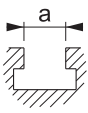
- This is the coupling set produced from steel product in order to couple the work piece or apparatuses on the table in a rapid and safe way.

Nr.	L	b1		a	e2	b2
1330	80	11	M10	15	30	30
1330	100	14.5	M12-M14	20	40	40
1330	125				40	40
1330	125	18.5	M16-M18	25	45	50
1330	160				65	50
1330	160	22.5	M20-M22	30	60	60
1330	200				80	60

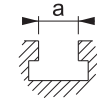

												
	DIN 508	DIN 6330 B	Nr 1830	DIN 6331	DIN 6340							
12	M10	M10	M10	M10	M10	 <table border="1"> <tr> <td>Nr.</td> <td>12-14</td> </tr> <tr> <td>1950</td> <td>16-18</td> </tr> <tr> <td></td> <td>20-22</td> </tr> </table>	Nr.	12-14	1950	16-18		20-22
Nr.	12-14											
1950	16-18											
	20-22											
14	M12	M12	M12	M12	M12							
16	M14	M14	M14	M14	M14							
18	M16	M16	M16	M16	M16							
20	M18	M18	M18	M18	M18							
22	M20	M20	M20	M20	M20							



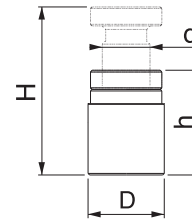

Nr.	h	H	d	D
1510	23	30	M16	34
1510	40	60	M16	34
1510	70	100	Tr 30x4	50
1510	100	140	Tr 30x4	50

**Ürün: 52 Parça Vida Yükselticili İş Bağlama Set**

- 6 adet DIN 508 T-Pabuç (M20x22'de 4 adet)
- 16 adet DIN 6379 saplama
- 6 adet DIN 6330B takviyeli somun
- 4 adet DIN 6331 pullu somun
- 2 adet Nr. 1830 uzatma somun
- 4 adet DIN 6340 kalın pul
- 4 adet Nr. 1330 destek delikli pabuç
- 8 adet Nr. 1510 vida diş yükseltici destek
- 1 adet Nr. 1950 T-Kanal temizleyici
- 1 adet statik boyalı çelik set
- Not: M20 VBS'de somun ve pul 4'er adet
- M10-12 VBS'de 1510 yükseltici 6 adet konulmaktadır.

**Product: 52 piece set of Screwed Coupling Set with Lifter**

- 6 pieces of DIN 508 T-Nut (M20x22 4 piece)
- 16 pieces of DIN 6379 Stud
- 6 pieces of DIN 6330B Supported Nut
- 4 pieces of DIN 6331 Nut with Washer
- 2 pieces of No. 1830 Extension Nut
- 4 pieces of DIN 6340 Thick Washer
- 4 pieces of No. 1330 Clamp with Support Hole
- 8 pieces of No. 1510 Screw Thread Lifter Support
- 1 piece of No. 1950 T-Slot Scraper
- 1 piece of Steel Set with Statical Paint
- Note: 1990-2022= Hexagon nut and washer = 4 pcs
- 1990-1012 and 1990-1214= 1510 support 6 pcs

Referans Nr.				DIN 6379 
	dx		(kg)	d x L
2010-1012	M10x12	330x255	7.27	M10x80-100-160-200
2010-1214	M12x14	380x255	9.26	M12x80-100-160-200
2010-1416	M14x16	435x255	12.29	M14x80-100-160-200
2010-1618	M16x18	435x255	15.62	M16x80-100-160-200
2010-1820	M18x20	495x255	18.00	M18x80-100-160-200

**Ürün Nr. 2010 Merdiven Yükselticili Bağlama Set**

- Tabla üzerine iş parçası ve aparatların hızlı ve güvenli bir şekilde bağlanması için çelik mamülden üretilmiş parçalardan oluşan bağlama seti.



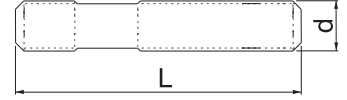

**Product Nr. 2010 Coupling Set with Serrated Hell Block**

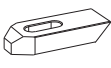
- This is the coupling set produced from steel product in order to couple the work piece or apparatuses on the table in a rapid and safe way.

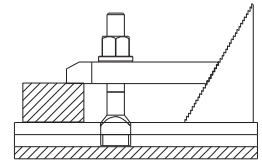
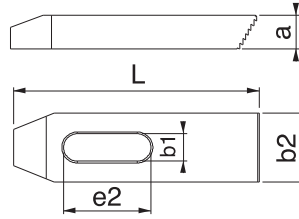

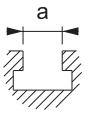
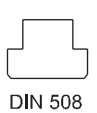
Nr.	L	b1		a	e2	b2
1290	80 100	11	M10	15	30 45	30
1290	100 125	14.5	M12-M14	20	45 55	40
1290	125 160	185	M16-M18	25	65 65	50



					
a	DIN 508	DIN 6330 B	Nr 1830	DIN 6331	DIN 6340
12	M10	M10	M10	M10	M10
14	M12	M12	M12	M12	M12
16	M14	M14	M14	M14	M14
18	M16	M16	M16	M16	M16
20	M18	M18	M18	M18	M18

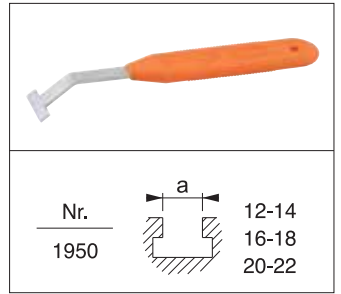

Nr.		
1950		12-14 16-18 20-22

Nr.	h-H	a	min-max
1310	37-85	57	0-40
1310	48-112	73	0-60
1310	58-139	90	0-75
1310	66-165	108	0-90

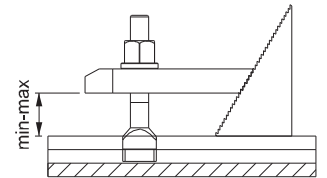
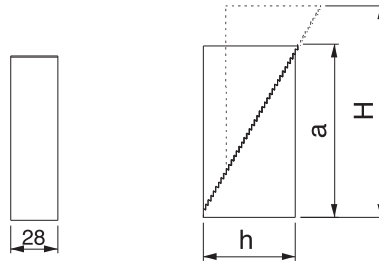

**Ürün: 52 Parça Merdiven Destekli İş Bağlama Set**

- 6 adet DIN 508 T-Pabuç
- 16 adet DIN 6379 saplama
- 6 adet DIN 6330B takviyeli somun
- 4 adet DIN 6331 pullu somun
- 2 adet 1830 uzatma somun
- 4 adet DIN 6340 kalın pul
- 4 adet Nr.1290 merdiven pabuç
- 8 adet Nr. 1310 merdiven diş destek
- 1 adet Nr. 1950 T-Kanal temizleyici
- 1 adet statik boyalı çelik set

**Product: 52 piece set of Coupling Set with Serrated Hell Block**

- 6 pieces of DIN 508 T-Nut (M20x22 4 piece)
- 16 pieces of DIN 6379 Stud
- 6 pieces of DIN 6330B Supported Nut
- 4 pieces of DIN 6331 Nut with Washer
- 2 pieces of No. 1830 Extension Nut
- 4 pieces of DIN 6340 Thick Washer
- 4 pieces of No. 1290 Serrated Clamp
- 8 pieces of No. 1310 Clamp with Support Hole
- 1 piece of No. 1950 T-Slot Scraper
- 1 piece of Steel Set with Statical Paint

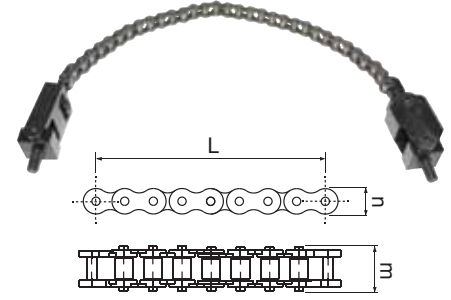
Referans Nr.			Tork Torque Nm	Sıkma Kuvveti Clamping Force kgf	L	m	n	(g)
2020-120125	M12	14-16-18	45	1500	125	20	15	1414
2020-120250	M12		45	1500	250	20	15	1528
2020-120500	M12		45	1500	500	20	15	1755
2020-121000	M12		45	1500	1000	20	15	2210
2020-160125	M16	18-20-22-24	90	4000	125	33	21	3495
2020-160250	M16		90	4000	250	33	21	3810
2020-160500	M16		90	4000	500	33	21	4480
2020-161000	M16		90	4000	1000	33	21	5820



**Ürün Nr. 2020 Zincirli Sıkma**

- Silindirik ve oval iş parçalarının bağlanabilmesi için tasarlanmıştır.
- Sertleştirilmiş
- Siyah kaplama

**Product Nr. 2020 Fixture Chain**

- It is designed for clamping of cylinder and oval workpieces.
- Hardened
- Black coated

Referans Nr.		a	b	c	e1	f1	h1 min	h1 max	m	s1	Sıkma Kuvveti Clamping Force kgf	(g)
2020-12125	14-16-18	36	36	18	49	21	96	125	M12	35	1500	580
2020-16162	18-20-22-24	37	44	25	64	29	117	162	M16	45	4000	1275

**Ürün Nr. 2020 Ayar Ünitesi**

- Sertleştirilmiş
- Siyah kaplama

**Product Nr. 2020 Setting Unit**

- Hardened
- Black coated

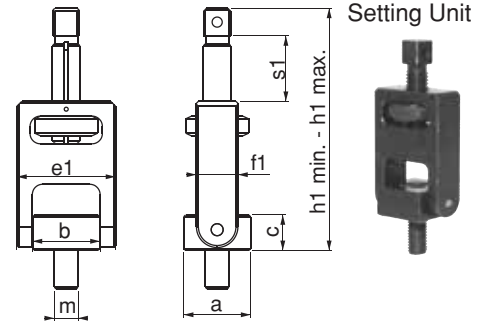

**Ayar Ünitesi**

Setting Unit

Referans Nr.		a	b	c	e2	f2	h2 min	h2 max	m	s2	sw	Tork Torque Nm	Sıkma Kuvveti Clamping Force kgf	(g)
2020-12127	14-16-18	36	36	18	54	49	111	127	M12	16	36	45	1500	945
2020-16170	18-20-22-24	37	44	25	70	62	140	170	M16	30	46	90	4000	1890

**Ürün Nr. 2020 Kanca Ünitesi**

- Sertleştirilmiş
- Siyah kaplama

**Product Nr. 2020 Hook Unit**

- Hardened
- Black coated

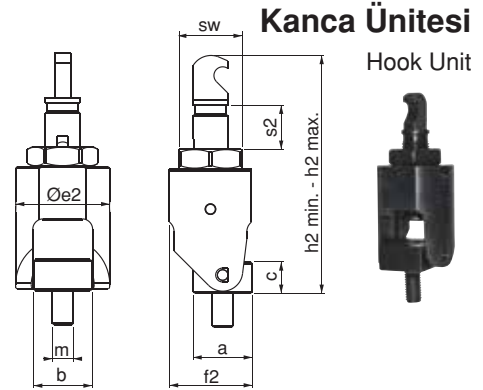
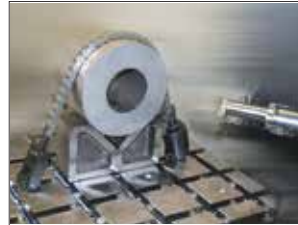

**Kanca Ünitesi**

Hook Unit

Referans Nr.	L1	L2	(g)
2020-127	127-173	97	0.35
2020-164	164-225	126	0.80

**Ürün Nr. 2020 Zincir Soketi**

- Zincir burkulmalarını önlemek için kullanılır
- Sertleştirilmiş
- Siyah kaplama

**Product Nr. 2020 Chain Socket**

- Used to prevent chain buckling.
- Hardened
- Black coated

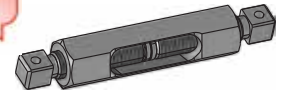
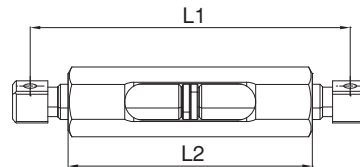

**Zincir Soketi**

Chain Socket

Referans Nr.	SW	SW1	(g)
2020-46	36	1/2	0.32
2020-36	46	1/2	0.52

**Ürün Nr. 2020 Tork Anahtarı Soketi**

- Tork anahtarı için kullanılır.
- Sertleştirilmiş
- Siyah kaplama

**Product Nr. 2020 Torque Wrench Socket**

- Used to for torque wrench.
- Hardened
- Black coated

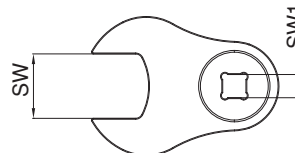

**Tork Anahtarı Soketi**

Torque Wrench Socket