



YANDAN BAĞLAMA PABUÇLAR

SIDE CLAMPS



Referans Nr.		c	L	b	n	k	k1	k2	L1	d	d1	d2	sw	sıkma kuvveti clamping force Kgf	Tork Değeri Allowable Screw Torque (N-m)	
2030-14	14	5	90	23	47	47	26	26	65	M12	M12	M12	10	2000	35	3490
2030-16	16															3670
2030-18	18															5000
2030-20	20															5355
2030-22	22															5720
2030-24	24															6190
2030-28	28															6650







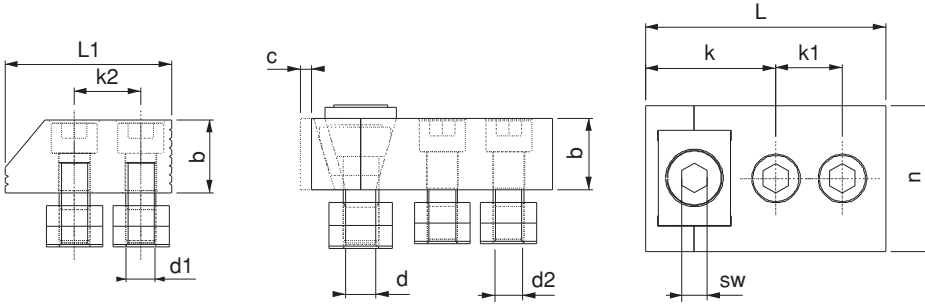

Ürün Nr. 2030 Dereceli Yandan Bağlama Set

- İş parçasını dayama yönünde sıkıldığında parçanın özgün yapısını değişikliğe sebep vermez
- Sertleştirilmiş
- Siyah kaplama
- Plastik kutuda set

Product Nr. 2030 Graded side Wrench Set

- When the product clamps the work piece in the direction of rest, it does not cause alteration in the genuine structure of the piece.
- Hardened
- Black coating
- Set is in the plastic box



Set İçindekiler / The set consists of						
Parça Part						
Adet Quantity	2	2	10	10	1	1

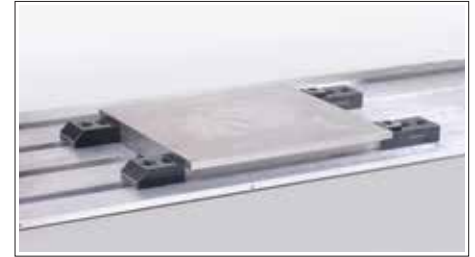

Dereceli Yandan Bağlama Gövde

Referans Nr.	
2035-14	14
2035-16	16
2035-18	18
2035-20	20
2035-22	22
2035-24	24
2035-28	28



Dereceli Yandan Bağlama Dayama

Referans Nr.	
2040-14	14
2040-16	16
2040-18	18
2040-20	20
2040-22	22
2040-24	24
2040-28	28

Not: Sabit dayamanın dereceli tarafı ince parçalar, düz tarafı ise kalın parçalarda kullanılmak üzere iki farklı şekilde kullanılabilir.

Note: Fixed rest can be used as two different ways: Graded side is used for thin pieces and the Straight side is used with thick pieces.



Referans Nr.		c	L	L1	L2	L3	b	b1 ±0.01	n	k	k1	k2	d	d1	d2	sw	sıkma kuvveti clamping force Kgf	Tork Değeri Allowable Screw Torque (N-m)	
2050-14	14	5	110	90	85	65	41	18	47	47	26	26	M12	M12	M12	6	1000	15	5920
2050-16	16																		6210
2050-18	18																		8090
2050-20	20																		8440
2050-22	22																		8825
2050-24	24																		10080
2050-28	28	10750																	



Ürün Nr. 2050 Dereceli Yandan Bağlama (Paralelli) Set

- İş parçasını dayama yönünde sıktığında parçanın özgün yapısını değişikliğe sebep vermez.

Paralelli oluşundan dolayı işlenen parçaya delik işlemi uygulanabilir.

- Sertleştirilmiş
- Siyah kaplama
- Plastik kutuda set

Product Nr. 2050 Graded side Wrench Set (With Parallel)

- When the product clamps the work piece in the direction of rest, it does not cause alteration in the genuine structure of the piece. Because of being with parallel, hole process can be applied on the machined piece.

- Hardened
- Black coating
- Set is in the plastic box

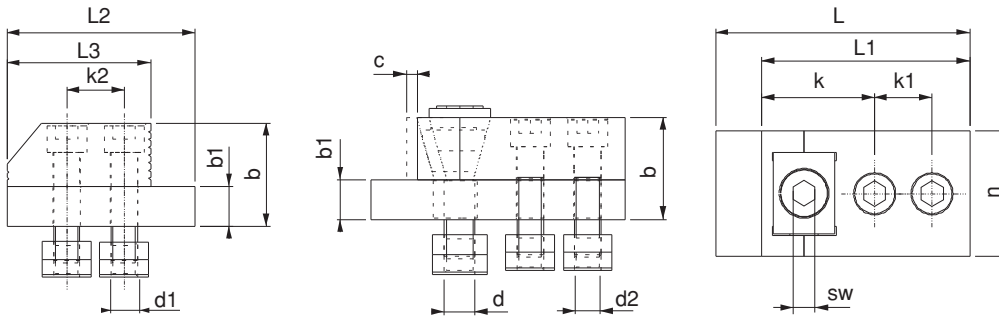

Set İçindekiler / The set consists of						
Parça Part						
Adet Quantity	2	2	10	10	2	1



Dereceli Yandan Bağlama (Paralelli) Gövde

Referans Nr.	
2055-14	14
2055-16	16
2055-18	18
2055-20	20
2055-22	22
2055-24	24
2055-28	28



Dereceli Yandan Bağlama (Paralelli) Dayama

Referans Nr.	
2060-14	14
2060-16	16
2060-18	18
2060-20	20
2060-22	22
2060-24	24
2060-28	28



Not: Sabit dayamanın dereceli tarafı ince parçalar, düz tarafı ise kalın parçalarda kullanılmak üzere iki farklı şekilde kullanılabilir. Note: Fixed rest can be used as two different ways: Graded side is used for thin pieces and the Straight side is used with thick pieces.

Referans Nr.		c	L	b	b1	n	n1	n2	k	k1	k2	sw	i	h	h1	d	d1	sıkma kuvveti clamping force Kgf	Tork Değeri Allowable Screw Torque (N-m)	
2070-14	14	10	142	24	8	37	12.5	18.5	65	54	26	6	65	23	10	M12	M12	850	15	3575
2070-16	16																			3710
2070-18	18																			5215
2070-20	20	14	145	28	10	48	12.5	18.5	74	56	26	8	65	28	11	M12	M12	1000	35	5400
2070-22	22																			5610

Ürün Nr. 2070 Kızaklı Yandan Bağlama Set

- Hareketli çenenin kızaklı yapısından dolayı iş parçasını dayama ve pleyt yönüne sıkır. Çenenin geniş hareketi iş parçasını bağlama ve sökme kolaylık sağlar.
- DIN 650 T-Kanala uyumludur
- Çene Sertlik : Sertleştirilmiş
- Siyah kaplama
- Plastik kutuda set

Product Nr. 2070 Sliding Side Wrench Set

- Because of the sliding structure of the moving jaw it clamps the work piece in the direction of resting and plate.
- Wide movement of the jaw provides convenience in coupling and dismantling of the workpiece.
- It is in compliance with DIN 650 T-Slot
- Hardness of jaw: Hardened
- Black coating
- Set is in the plastic box

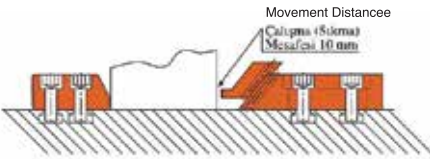
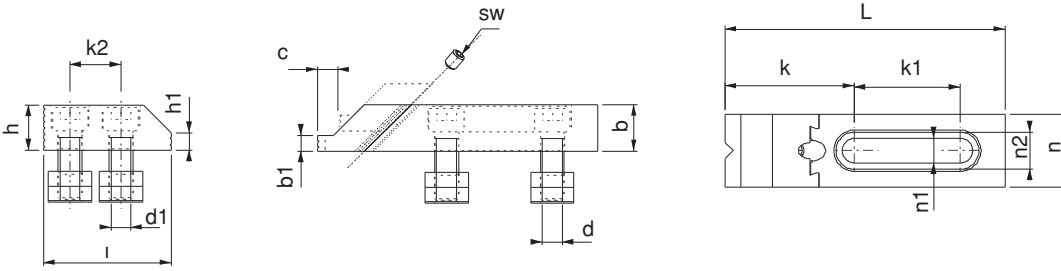

Not: Sabit dayamanın dereceli tarafı ince parçalar, düz tarafı ise kalın parçalarda kullanılmak üzere iki farklı şekilde kullanılabilir.

Note: Fixed rest can be used as two different ways: Graded side is used for thin pieces and the Straight side is used with thick pieces.

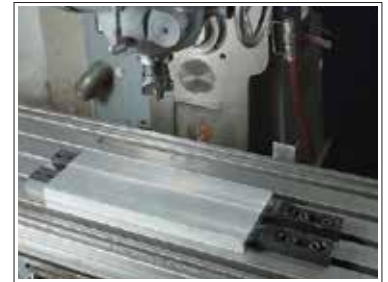

Set İçindekiler / The set consists of

Parça Part						
Adet Quantity	2	2	8	8	2	1

Kızaklı Yandan Bağlama Gövde

Sliding Side Wrench Body

Referans Nr.	
2075-14	14
2075-16	16
2075-18	18
2075-20	20
2075-22	22
2075-24	24
2075-28	28



Kızaklı Yandan Bağlama Dayama



Sliding Side Wrench Pluggable

Referans Nr.	
2040-14	14
2040-16	16
2040-18	18
2040-20	20
2040-22	22
2040-24	24
2040-28	28

Not: Sabit dayamanın dereceli tarafı ince parçalar, düz tarafı ise kalın parçalarda kullanılmak üzere iki farklı şekilde kullanılabilir.

Note: Fixed rest can be used as two different ways: Graded side is used for thin pieces and the Straight side is used with thick pieces.



Referans Nr.		Sıkma Kuvveti Clamping Force	
2070-MBS701212	12	2500	3.14
2070-MBS701214	14	2500	3.14
2070-MBS701216	16	2500	3.14
2070-MBS701218	18	2500	3.14
2070-MBS701220	20	2500	3.14

Ürün Nr. 2070 Yandan Bağlama Set

- Mafsallı tasarımıyla düz olmayan yüzeylerde dahi mevcut yüzey şeklini alarak emniyetli bağlama yapar.

Product Nr. 2070 Side Wrench Set

- With its articulated design, it makes safe bonding even on uneven surfaces by taking the existing surface shape.

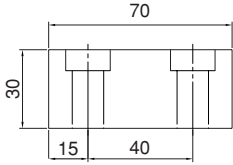

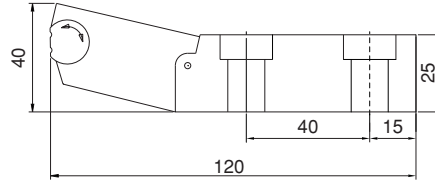

Genişlik / Width 40 mm.



Genişlik / Width 40 mm.



Referans Nr.		
2070-MS701114	14	0.87
2070-MS701116	16	0.87
2070-MS701118	18	0.87
2070-MS701120	20	0.87

Ürün Nr. 2070 Yandan Bağlama Gövde



- Mafsallı tasarımıyla düz olmayan yüzeylerde dahi mevcut yüzey şeklini alarak emniyetli bağlama yapar.

Product Nr. 2070 Side Press Body

- With its articulated design, it makes safe bonding even on uneven surfaces by taking the existing surface shape.

Yandan Bağlama Gövde





Referans Nr.		
2070-MD702114	14	0.65
2070-MD702116	16	0.65
2070-MD702118	18	0.65
2070-MD702120	20	0.65

Ürün Nr. 2070 Yandan Bağlama Dayama

Product Nr. 2070 Side Press Stopper

Yandan Bağlama Dayama



Referans Nr.		Sıkma Kuvveti Clamping Force	
2070-MBS801112	12	2500	6.15
2070-MBS801114	14	2500	6.15
2070-MBS801116	16	2500	6.15
2070-MBS801118	18	2500	6.15
2070-MBS801120	20	2500	6.15



Ürün Nr. 2070 Yandan Bağlama (Paralelli) Set

- Mafsallı tasarımıyla düz olmayan yüzeylerde dahi mevcut yüzey şeklini alarak emniyetli bağlama yapar.

Product Nr. 2070 Side Wrench Set (With Parallel)

- With its articulated design, it makes safe bonding even on uneven surfaces by taking the existing surface shape.

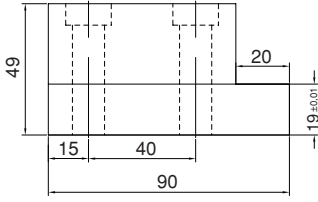

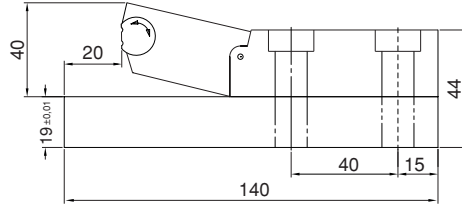

Genişlik / Width 40 mm.



Genişlik / Width 40 mm.



Referans Nr.		
2070-MS801214	14	1.86
2070-MS801216	16	1.86
2070-MS801218	18	1.86
2070-MS801220	20	1.86

Ürün Nr. 2070 Yandan Bağlama Gövde

- Mafsallı tasarımıyla düz olmayan yüzeylerde dahi mevcut yüzey şeklini alarak emniyetli bağlama yapar.

Product Nr. 2070 Side Press Body



- With its articulated design, it makes safe bonding even on uneven surfaces by taking the existing surface shape.



Yandan Bağlama Gövde

Side Press Body



Referans Nr.		
2070-MD802214	14	1.18
2070-MD802216	16	1.18
2070-MD802218	18	1.18
2070-MD802220	20	1.18

Ürün Nr. 2070 Yandan Bağlama Dayama

Product Nr. 2070 Side Press Stopper



Yandan Bağlama Dayama

Side Press Stopper



Referans Nr.	A	B	C	D	E	F	G	H	J	K	L	M	Sıkma Kuvveti Clamping Force Kgf	Tork Değeri Allowable Screw Torque (N-m)	
2072-08016	39.5	65	7.5	25	45	16	7	1.5	7	4	M8	25	400	8	160
2072-12022	60	85	10	40	60	22	12	2	9	6	M12	35	900	26	450
2072-16030	77	100	14	50	70	30	14	2	13	8	M16	40	1700	60	900

Ürün Nr. 2072 Yandan Bağlama

- Siyah Kaplama

Product Nr. 2072 Side Clamps

- Black Coating

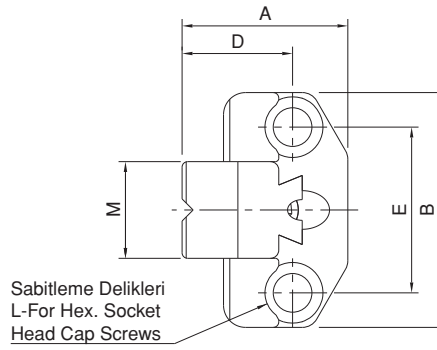
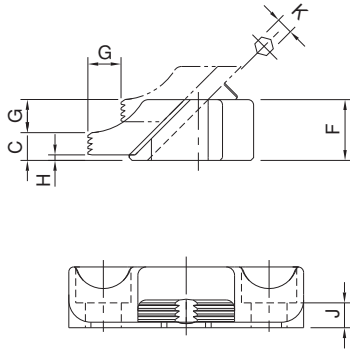
Yandan Bağlama

Side Clamps

Referans Nr.	A	B	C	D	E	F	G	H	J	K	L	M	Sıkma Kuvveti Clamping Force Kgf	Tork Değeri Allowable Screw Torque (N-m)	
2073-08016	39.5	65	19.5	25	45	16	7	1.5	7	4	M8	25	400	8	180
2073-12022	60	85	29	40	60	22	12	2	9	6	M12	35	900	26	500
2073-16030	77	100	38	50	70	30	14	2	13	8	M16	40	1700	60	1010

Ürün Nr. 2073 Yandan Bağlama

- Çene Sertlik: Sertleştirilmiş
- Siyah Kaplama

Product Nr. 2073 Side Clamps

- Hardness of jaw: Hardened
- Black Coating

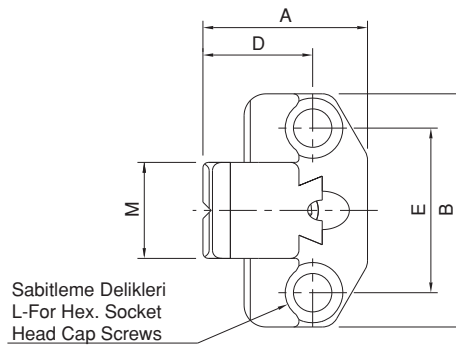
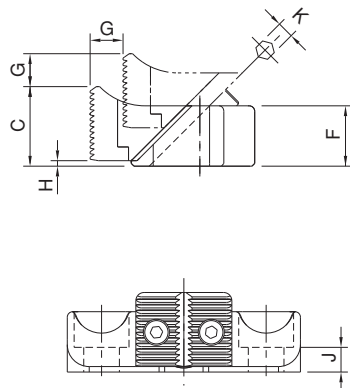

Referans Nr.	A	B	C	D	E	F	G	H	J	K	L	M	N
2077-08001	44	32	20	8	28.5	4	26.5	23	7	15	19	10	M8x1.25
2077-10001	54	40	25	10	35	5	33	29	9	16	24	12	M10x1.5
2077-12001	62	46	30	12	39.5	5.5	37.5	35	11	17	27	14	M12x1.75

Referans Nr.	P	Sıkma Kuvveti Clamping Force Kgf	Tork Değeri Allowable Screw Torque (N-m)	
2077-08001	6	350	45	160
2077-10001	8	550	55	310
2077-12001	10	700	70	490



Ürün Nr. 2077 Yandan Bağlama

- Siyah Kaplama

Product Nr. 2077 Side Clamps

- Black Coating

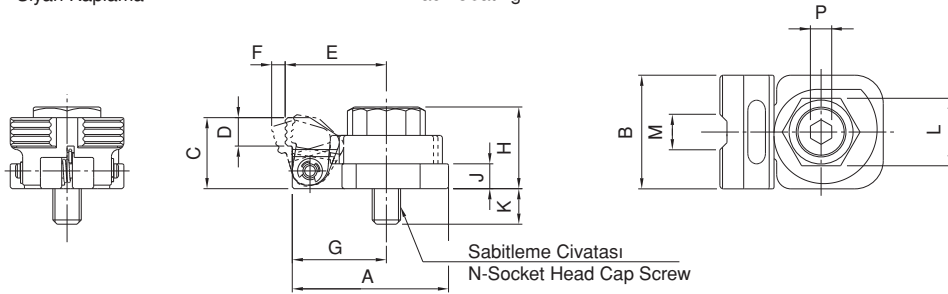

Kullanım Şekli / How To Use

- Önce parçayı sabitleyip sonra anahtar ile sıkma işlemi yapılır.
- Secure the body and the flanged collar with a socket head cap screw, and then turn the the cam with a wrench to clamp a workpiece.

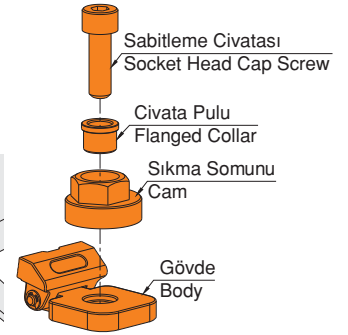
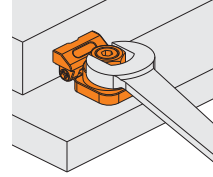

Yandan Bağlama

Side Clamps

Referans Nr.		A	H	L	S	Sıkma Kuvveti Clamping Force Kgf	
2080-014	14	61	57	108	5	1500	1850
2080-016	16	61	57	108	5	1500	1850
2080-018	18	61	57	108	5	1500	1850
2080-020	20	61	57	108	5	1500	1850
2080-022	22	61	57	108	5	1500	1850
2080-024	24	61	57	108	5	1500	1850
2080-028	28	61	57	108	5	1500	1850



Ürün Nr. 2080 Yandan Bağlama

- Vida kaldırması ile dikey ve yatay sıkma kuvveti sağlamakta.

Gövde

- Statik Boya
- Çene
- Sertleştirilmiş



Product Nr. 2080 Side Clamps

- Vertical down thrust and horizontal clamping force available simultaneously with the operation of leverage screw

Body

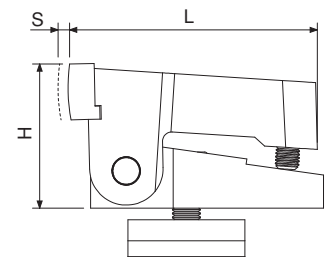
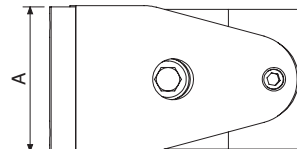
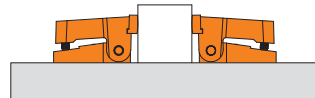
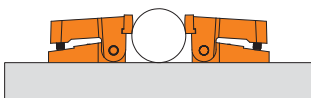
- Statical Painting
- Jaw
- Hardened



Referans Nr.		c	b	k1	k2	k3	k4	L	h	h1	d	d1	sıkma kuvveti clamping force Kgf	
2090-14	14	3.5	30	95	99	26	26	65	28	10	M12	M12	3500	7925
2090-16	16													8490
2090-18	18													4610
2090-20	20													8850
2090-22	22													9030
2090-24	24													9490
2090-28	28													9800







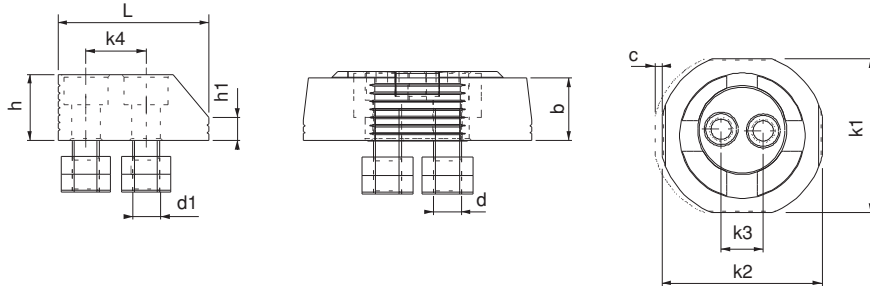

Ürün Nr. 2090 Kollu Yandan Bağlama Set

- Ürünün eksantrik çalışma sistemi saat yönünde sıkıldığında iş parçasını dayama ve pleyt yönüne özel dizayn anahtarı ile yüksek kuvvette sıkır.
- 1-Kollu yandan sıkma pabucunun eksantrik hareketi 3.5 mm'dir.
- 2-Ürün iş parçasına 1.5 - 2 mm yakınlaştırılır.
- 3-10 mm alyan ile imbus civataları sabitlenir.
- 4-Ürünü anahtarı ile saat yönünde çevirerek iş parçasını sabitleme işlemi gerçekleştirilir.
- DIN 650 T-Kanala uyumludur
- Somun Sertlik : Sertleştirilmiş
- Siyah kaplama
- Plastik kutuda set

Product Nr. 2090 Armed Side Press Set

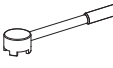
- When the eccentric working system of the product is tightened clockwise, it clamps the work piece with high force in the direction of resting and plate with it's special designed wrench.
- 1-Eccentric movement of Armed Side Clamp 3.5 mm.
- 2-It brings the product 1.5 - 2mm close to the work piece
- 3-Imbus bolts are fixed with 10mm allen.
- 4-Fixing of the work piece is implemented by turning the product clockwise with the wrench.
- It is in compliance with DIN 650 T-Slot
- Hardness of nut: Hardened
- Black coating
- Set is in the plastic box



Set İçindekiler / The set consists of							
Parça Part							
Adet Quantity	2	2	1	8	8	1	1

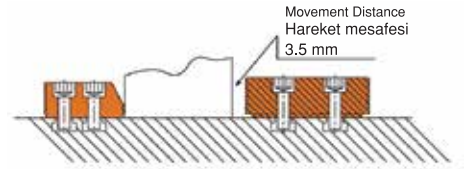

Not: Sabit dayamanın dereceli tarafı ince parçalar, düz tarafı ise kalın parçalarda kullanılmak üzere iki farklı şekilde kullanılabilir.

Note: Fixed rest can be used as two different ways: Graded side is used for thin pieces and the Straight side is used with thick pieces.

Referans Nr.	
2090-114	14
2090-116	16
2090-118	18
2090-120	20
2090-122	22
2090-124	24
2090-128	28

Kollu Yandan Bağlama Gövde

Armed Side Press Body



Referans Nr.	
2040-14	14
2040-16	16
2040-18	18
2040-20	20
2040-22	22
2040-24	24
2040-28	28



Not: Sabit dayamanın dereceli tarafı ince parçalar, düz tarafı ise kalın parçalarda kullanılmak üzere iki farklı şekilde kullanılabilir.

Note: Fixed rest can be used as two different ways: Graded side is used for thin pieces and the Straight side is used with thick pieces.

Kollu Yandan Bağlama Dayama

Armed Side Press Pluggable



Referans Nr.		a1	a2	b	b1	c	h min-max	L	sw	F1 Sıkma kuvveti Clamping force Kgf	F2 Sıkma kuvveti Clamping force Kgf	 (kg)
2095-571	14-16-18	37	37	57	19	8	78-98	185	10	2250	350	3.68
2095-761	20-22-24-28	37	45	76	26	11	98-118	240	14	3000	450	7.66

Ürün Nr. 2095 Blok Yandan Bağlama



- İş parçasını dayama ve pleyt yönüne sıkır özellikle yüksek iş parçaları için tasarlanmıştır
- Çene Sertlik: Sertleştirilmiş
- Siyah kaplama

Product Nr. 2095 Block Side Press

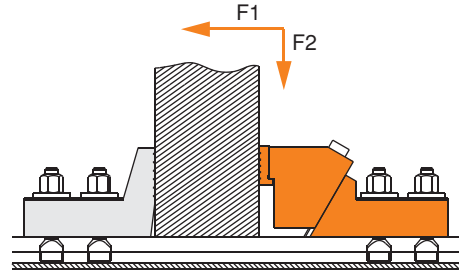
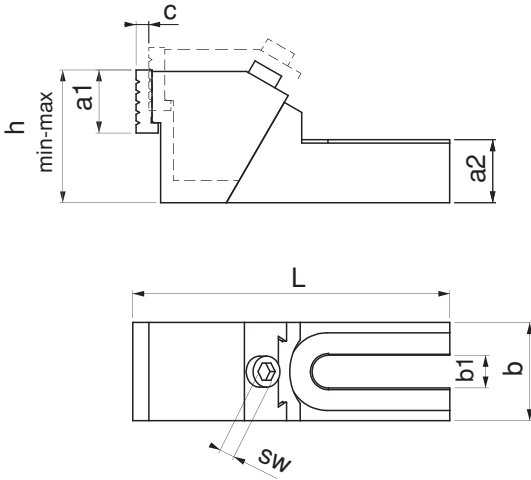
- It clamps the workpieces in clamp rest direction and plate direction, it is designed especially for high workpieces.
- Hardness of jaw: Hardened
- Black coating



Blok Yandan Bağlama

Referans Nr.		a1	a2	b	b1	c	h min-max	L	sw	F1 Sıkma kuvveti Clamping force Kgf	F2 Sıkma kuvveti Clamping force Kgf	 (kg)
2095-572	14-16-18	37	37	57	19	8	78-98	185	10	2250	350	3.6
2095-762	20-22-24-28	37	45	76	26	11	98-118	240	14	3000	450	6.7



Ürün Nr. 2095 Blok Yandan Bağlama

- İş parçasını dayama ve pleyt yönüne sıkır büyük plakaların bağlanabilmesi için tasarlanmıştır
- Çene Sertlik: Sertleştirilmiş
- Siyah kaplama

Product Nr. 2095 Block Side Press

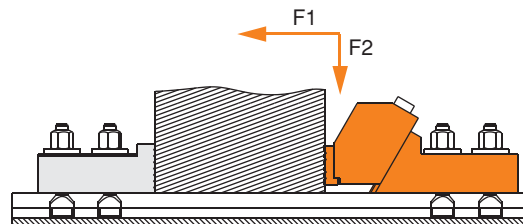
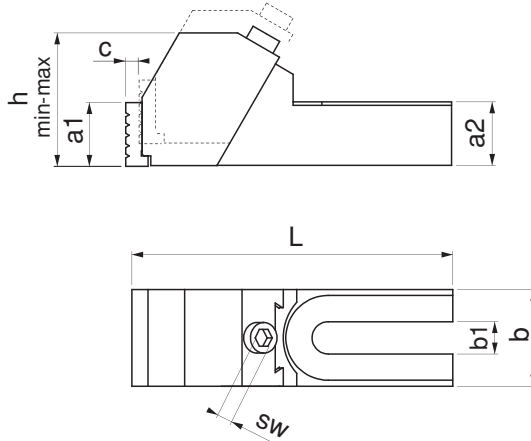
- It clamps the workpieces in clamp rest direction and plate direction, it is designed for clamping big plates.
- Hardness of jaw: Hardened
- Black coated



Referans Nr.		a2	b	b1	h	L	 (kg)
2098-571	14-16-18	37	57	19	85	124	2.025
2098-761	20-22-24-28	45	76	26	105	154	4.185

Ürün Nr. 2098 Blok Yandan Bağlama Dayaması



- 2095-571 ve 761 pabuçlar için dayama olarak tasarlanmıştır.
- Siyah kaplama

Product Nr. 2098 Block Stopper Side Press

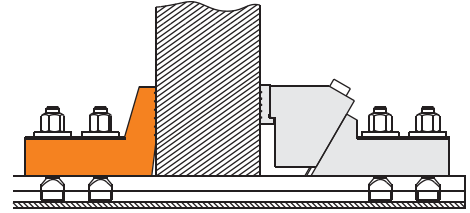
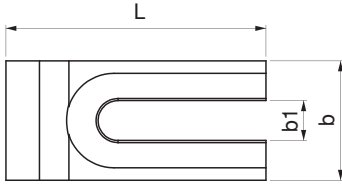
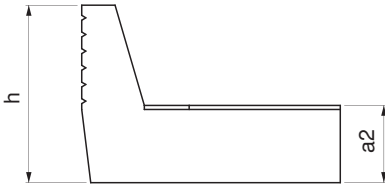
- It is designed as clamp rest for clamps 2095-571 and 761.
- Black coating



Blok Yandan Bağlama Dayaması

Referans Nr.		a2	b	b1	h	L	 (kg)
2098-572	14-16-18	37	57	19	47	112	2.800
2098-762	20-22-24-28	45	76	26	49	140	4.185

Ürün Nr. 2098 Blok Yandan Bağlama Dayaması

- 2095-572 ve 762 pabuçlar için dayama olarak tasarlanmıştır.
- Siyah kaplama

Product Nr. 2098 Block Stopper Side Press

- It is designed as clamp rest for clamps 2095-572 and 762.
- Black coating

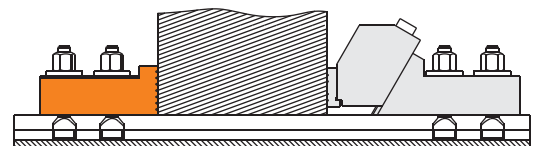
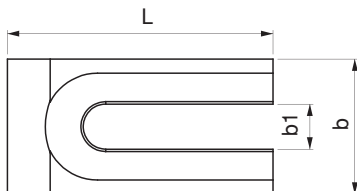
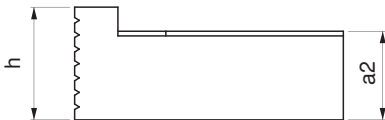

Referans Nr.	a	Sıkma Kuvveti Clamping Force	(kg)
2105-MYB404114	14	3600	2.80
2105-MYB404116	16	3600	2.80
2105-MYB404118	18	3600	2.80
2105-MYB404120	20	3600	2.80
2105-MYB404122	22	3600	2.80
2105-MYB404124	24	3600	2.80

Ürün Nr. 2105 Blok Yandan Bağlama
Product Nr. 2105 Block Side Press

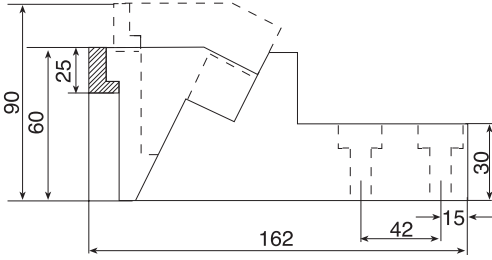

Genişlik / Width 54 mm.



Referans Nr.	a	Sıkma Kuvveti Clamping Force	(kg)
2105-MYB901120	20	6000	6.85
2105-MYB901122	22	6000	6.85
2105-MYB901124	24	6000	6.85
2105-MYB901128	28	6000	6.85

Ürün Nr. 2105 Blok Yandan Bağlama
Product Nr. 2105 Block Side Press

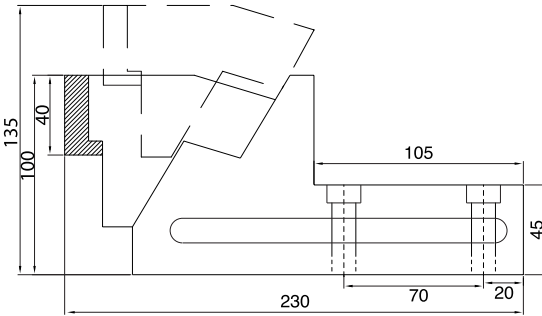

Genişlik / Width 68 mm.



Referans Nr.	a	Sıkma Kuvveti Clamping Force	(kg)
2105-MYB303114	14	3600	2.80
2105-MYB303116	16	3600	2.80
2105-MYB303118	18	3600	2.80
2105-MYB303120	20	3600	2.80
2105-MYB303122	22	3600	2.80
2105-MYB303124	24	3600	2.80

Ürün Nr. 2105 Blok Yandan Bağlama
Product Nr. 2105 Block Side Press

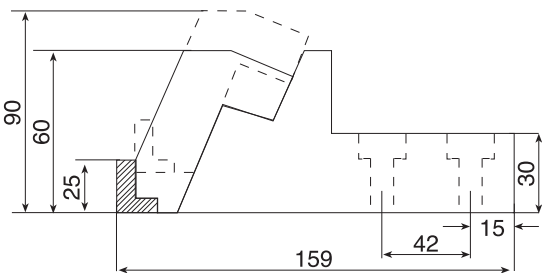

Genişlik / Width 54 mm.



Referans Nr.	a	(kg)
2105-MD404214	14	1.86
2105-MD404216	16	1.86
2105-MD404218	18	1.86
2105-MD404220	20	1.86
2105-MD404222	22	1.86
2105-MD404224	24	1.86

Ürün Nr. 2105 Blok Yandan Bağlama Dayaması
Product Nr. 2105 Block Stopper Side Press

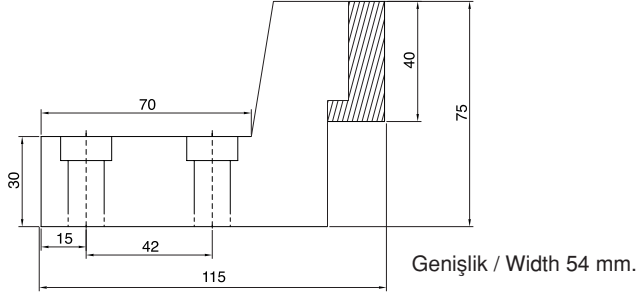

Blok Yandan Bağlama Dayaması

Block Stopper Side Press



Referans Nr.	a	(kg)
2105-MD902120	20	4.50
2105-MD902122	22	4.50
2105-MD902124	24	4.50
2105-MD902128	28	4.50

Ürün Nr. 2105 Blok Yandan Bağlama Dayaması
Product Nr. 2105 Block Stopper Side Press

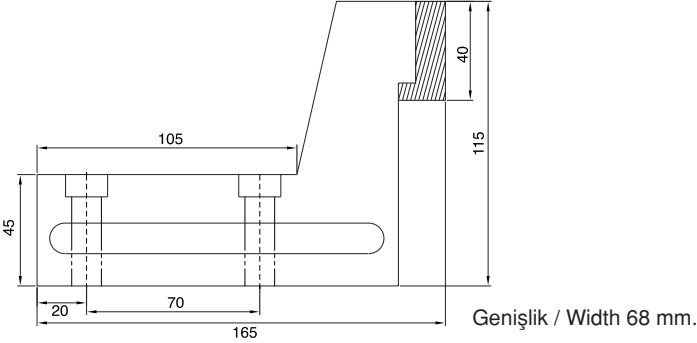

Blok Yandan Bağlama Dayaması

Block Stopper Side Press

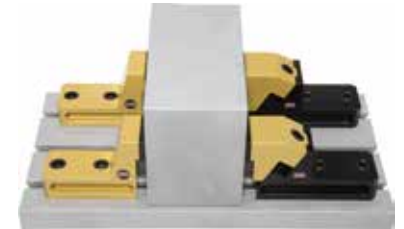

Referans Nr.	a	(kg)
2105-MD303214	14	1.17
2105-MD303216	16	1.17
2105-MD303218	18	1.17
2105-MD303220	20	1.17
2105-MD303222	22	1.17
2105-MD303224	24	1.17

Ürün Nr. 2105 Blok Yandan Bağlama Dayaması
Product Nr. 2105 Block Stopper Side Press

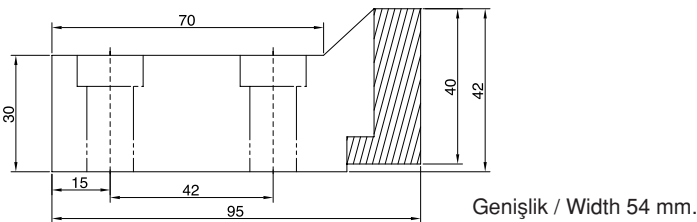

Blok Yandan Bağlama Dayaması

Block Stopper Side Press



Referans Nr.		c	h	b	L	L1	L2	sw	d	Sıkma Kuvveti Clamping Force		
										f1 Kgf	f2 Kgf	
2110-12	12	3	20	40	80	39	26	6	M10	1600	60	415
2110-14	14									2200	90	425
2110-16	16									3200	120	785
2110-18	18	4	25	50	100	46	34	8	M14	3600	140	810
2110-20	20									3600	140	850
2110-22	22									3600	140	2275
2110-24	24	5	28.5	78	140	65	50	10	M20	3600	140	2360
2110-28	28									4000	160	2500

Ürün Nr. 2110 Çift Çeneli Yandan Bağlama

- İş parçasını dayama ve pleyt yönünde sıkar, pabucun yapısından dolayı kuvvetli sıkma yapar.
- Sertleştirilmiş
- Siyah kaplama

Product Nr. 2110 Side Press Clamp with Double Claw

- Product clamps the work piece in the direction of rest and plate. It achieves powerful clamping because of the clamp's structure.
- Hardened
- Black coating

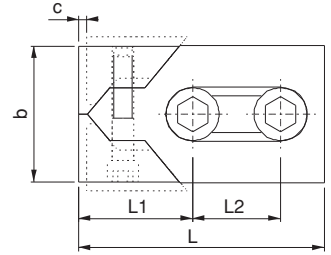
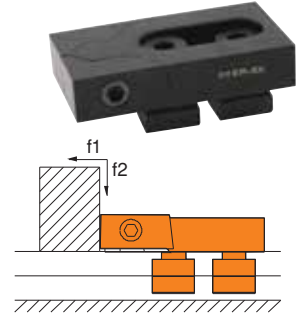
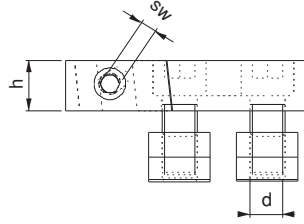

Referans Nr.		a h6	b -0.6	C DIN 650	d ±0.01	h1 ±0.01	h1 ±0.02	h2	h3	ISO 4762	
2120-1450	14	0-0.011	14	24	32	-	50	9	8	M8x60	355
2120-1825	18	0-0.011	18	30	40	25	-	15	10	M10x40	360
2120-1850	18	0-0.011	18	30	40	-	50	15	10	M10x65	600
2120-2225	22	0-0.013	22	38	40	25	-	15	14	M10x50	410
2120-2250	22	0-0.013	22	38	40	-	50	15	14	M10x75	650

Ürün Nr. 2120 Silindir Dayama

- Sertleştirilmiş
- Siyah Kaplama

Product Nr. 2120 Cylinder Pluggable

- Hardened
- Black coating

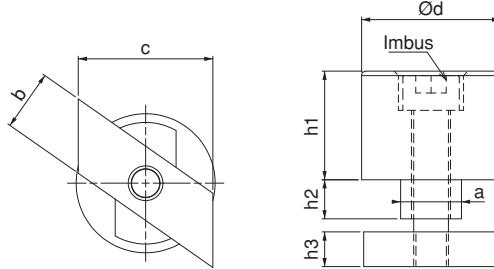

Silindir Dayama Cylinder Pluggable

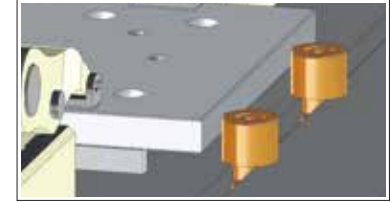

Referans Nr.		n	e	c	d	b	h	k	L	sw	
2130-14	14	13.7	22	22	M8	11	4	8	44	6	180
2130-16	16	15.7	25	25	M12	12.5	5	9	50	10	270
2130-18	18	17.7	28	28	M12	14	5	10	56	10	355
2130-20	20	19.7	32	32	M16	16	5	12	64	14	570
2130-22	22	21.7	35	35	M16	17.5	6	14	70	14	770
2130-24	24	23.7	40	40	M20	20	6	16	80	17	1180
2130-28	28	27.7	44	44	M20	22	6	18	88	17	1560

Ürün Nr. 2130 Dayama

- Dayama referans alma, uzunlamasına ve enlemesine kullanılır.
- Sertleştirilmiş
- Siyah kaplama

Product Nr. 2130 Clamp Rest

- Clamp Rest is used for reference taking, longitudinal and cross-wise.
- Hardened
- Black coating

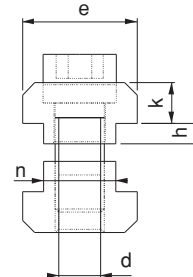
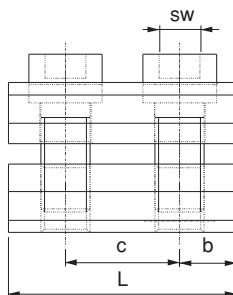

Dayama Clamp Rest



Referans Nr.	Stopersiz Kullanım In Use Without Slip Stopper		Stoperli Kullanım In Use With Slip Stopper		 (kg)
	Sıkma Kuvveti Clamping Force Kgf	Tork Değeri Allowable Screw Torque (N-m)	Sıkma Kuvveti Clamping Force Kgf	Tork Değeri Allowable Screw Torque (N-m)	
2135-1260	2900	38	6900	90	2.4

M12 civata için 4 adet pul dahildir.
4 washers for M12 bolts are included.

Ürün Nr. 2135 Yandan Bağlama

Gövde

- Malzeme: Dökme Demir
- Siyah kaplama

Çene

- Sertleştirilmiş
- Siyah Kaplama

Civata

- Sertlik: İndüksiyon
- Siyah Kaplama

Product Nr. 2135 Side Clamps

Body

- Material: Cast Iron
- Black coating

Jaw

- Hardened
- Black coating

Bolt

- Hardness: Induction
- Black coating

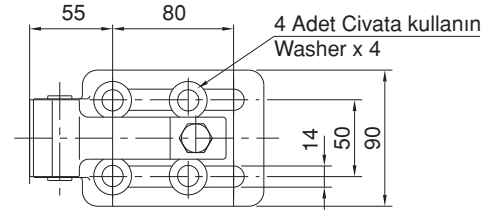
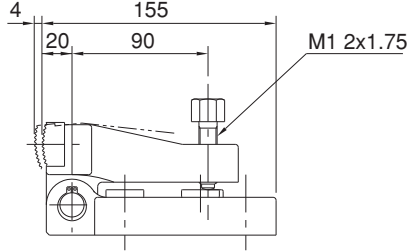
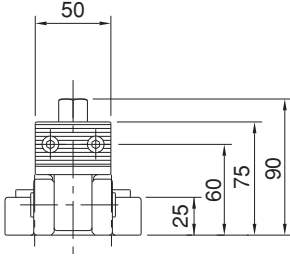

Yandan Bağlama

Side Clamps

Referans Nr.	Sıkma Kuvveti Clamping Force Kgf	Tork Değeri Allowable Screw Torque (N-m)	 (kg)
2137-16060	5800	150	2.9

M12 ve M16 vidalar için 2 adet dereceli pul dahildir.
2 spherical washers for both M12 and M16 screws are included.

Ürün Nr. 2137 Yandan Bağlama

Gövde

- Malzeme: Dökme Demir
- Siyah kaplama

Çene

- Sertleştirilmiş
- Siyah Kaplama

Civata

- Sertlik: İndüksiyon
- Siyah Kaplama

Product Nr. 2137 Side Clamps

Body

- Material: Cast Iron
- Black coating

Jaw

- Hardened
- Black coating

Bolt

- Hardness: Induction
- Black coating

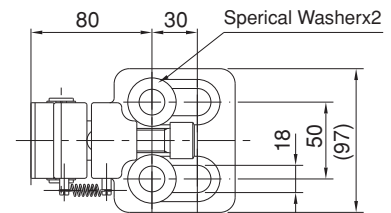
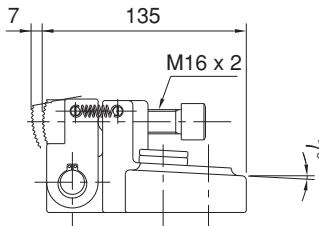
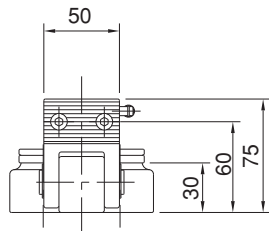

Referans Nr.	W1	W2	H1	H2	M	P1	H4	L4	W	L3	H5	d	L5	P
2139-32150	45	15	27	18	M4x0.7	30	18	13	75	20	8	6.6	3	60
2139-40200	60	20	33	22	M5x0.8	40	22	17	100	26	10	8.6	4	80

Referans Nr.	H	L	L2	R	L1	H3	M1
2139-32150	32	51	48	63	51.5	18	M4x0.7
2139-40200	40	67	63	80	67	22	M5x0.8

Referans Nr.	A	Sıkma Torku Clamping Stroke	Çalışma Yüğü Operating Load (N)	Sıkma Kuvveti Clamping Force Kgf	(g)
2139-32150	19	1.6	150	200	620
2139-40200	24	2.2	200	300	1360



Ürün Nr. 2139 Tek Dokunuş Yandan Bağlama
• Siyah kaplama

Product Nr. 2139 Cam Edge Clamps
• Black coating

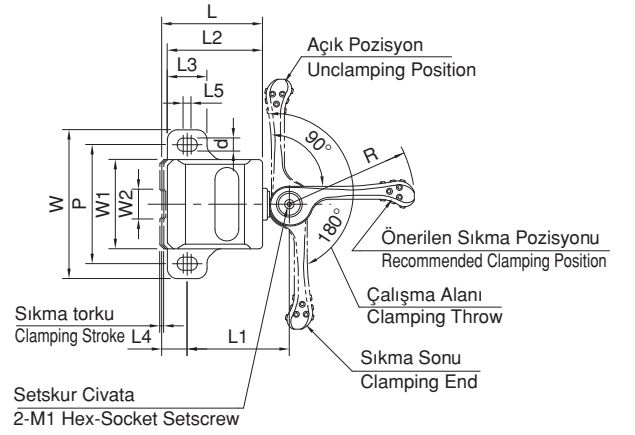
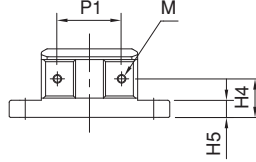
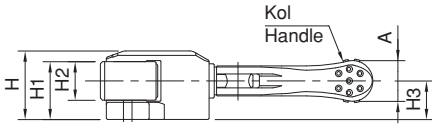

Özellikler

- Kol ile tek dokunuşta sıkma.
- Finiş işlerde mükemmel bağlama.
- Parçanın kalkmaması için çeneyi aşağı ve ileri iter.

Features

- The cam handle allows fast clamping in single operation.
- Precision-ground jaw is perfect for clamping the workpiece on its finished surface.
- In clamping, the jaw provides downward force to prevent part lift.

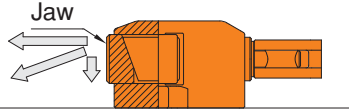

Kullanım Şekli How To Use

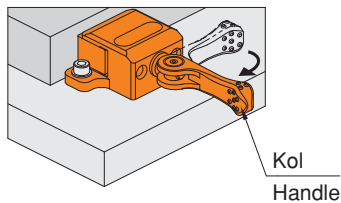

Kol Konumunu Değiştirme 90 derece 4 opsiyonlu kullanım

Changing Handle Position
The handle shaft has 4 countersinks which are provided every 90° for 4 options of handle position

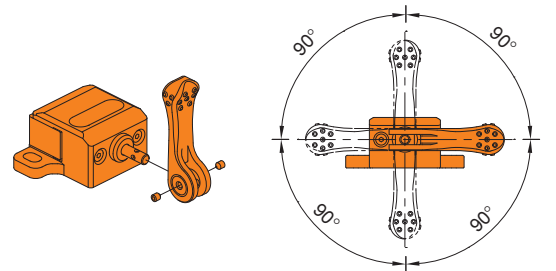

Referans Nr.	Sıkma Torku Clamping Stroke	W1	W2	H3	H4	L2	W	L	H2	d	P	H5	L1
2141-00010	1	38	8	6	3	15	45	33.5	10	5.2	36	5	30.5
2141-00015	2	60	12	9	5	22	70	50	15	8.2	55	7	46

Referans Nr.	H	D	H1	R	A	W3	M1	İzin Verilen Tork Allowable Screw Torque (N m)	Sıkma Kuvveti Clamping Force Kgf	
2141-00010	30	13	20	63	12	6	M4x0.7	10	400	85
2141-00015	46	19	30	100	18	10	M5x0.8	27	600	290

Ürün Nr. 2141 Yandan Bağlama

- Gövde**
- Siyah kaplama
- Çene**
- Sertleştirilmiş
 - Siyah Kaplama

Product Nr. 2141 Side Clamps

- Body**
- Black coating
- Jaw**
- Hardened
 - Black coating

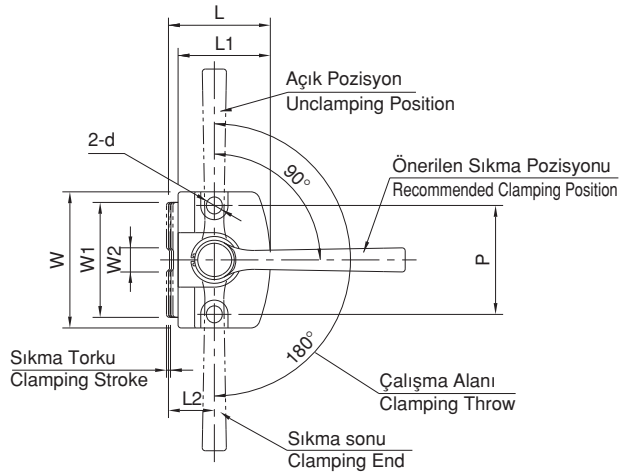

Kullanım Şekli / How To Use

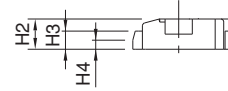
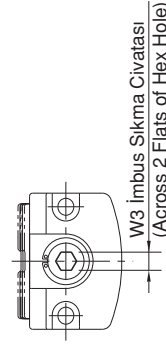
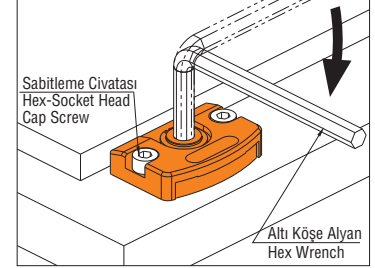

Referans Nr.	S	W	W1	H1	L1	P	D (h7)	H2	M	L	H	T	Sıkma Kuvveti Clamping Force Kgf	Tork Değeri Allowable Screw Torque (N-m)	
2143-08015	3	25	10	25	21.5	10	6	7	M8	32	15	1.6	700	25	115
2143-10019	4	30	11	32	26	12	6	7	M10	40	19	2	850	50	225
2143-12023	5	35	12	38	33	16	8	10	M12	50	23	2.3	2000	90	390
2143-16025	6	40	14	45	40	20	10	10	M16	60	25	3.2	3000	150	640

Yandan Bağlama



Ürün Nr. 2143 Yandan Bağlama

- Sertleştirilmiş
- Siyah Kaplama

Product Nr. 2143 Side Clamps

- Hardened
- Black coating

Kurulum ve Kullanım Şekli / How To Use and Install

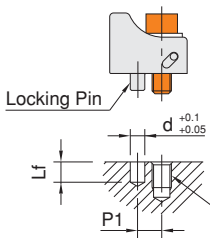

Nr.	M1	d	Lf	P1
CP107-08015	M 8	6	8	10
CP107-10019	M10	6	8	12
CP107-12023	M12	8	11	16
CP107-16025	M16	10	11	20

Üst tarafta görüldüğü gibi sabitlemek için bir pim, bir civata deliği gerekli.

Drill a cap-screw hole and a locking-pin hole as specified on the up.

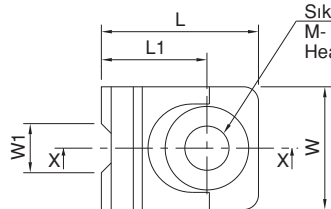
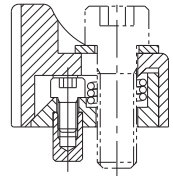
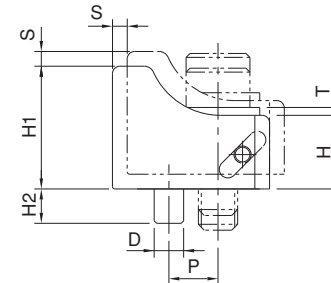
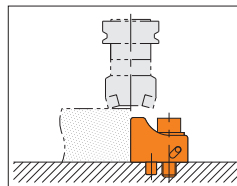

Sıkma Cıvatası
M- Hex. Socket
Head Cap Screws

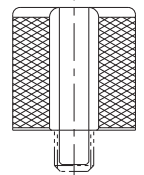

Referans Nr.	s	w	w1	h1	L1	P	d (h7)	h2	M	L	h	t	Sıkma Kuvveti Clamping Force (N)	İzin Verilen Vida Torqu Allowable Screw Torque (N·m)	(g)
2144-08015	3	25	10	6	24.5	10	6	7	M8	35	15	1.6	7.000	25	100
2144-10019	4	30	11	8	29	12	6	7	M10	43	19	2	8.500	50	185
2144-12023	5	35	12	9	37	16	8	10	M12	54	23	2.3	20.000	90	320
2144-16025	6	40	14	10	45	20	10	10	M16	65	25	3.2	30.000	150	520

Ürün Nr. 2144 Yandan Bağlama

- Sertleştirilmiş
- Siyah kaplama

Product Nr. 2144 Side Clamp

- Hardened
- Black coating

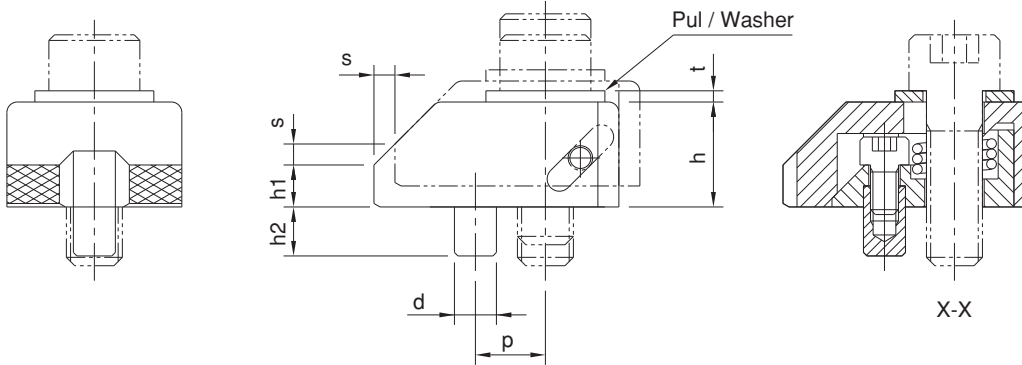
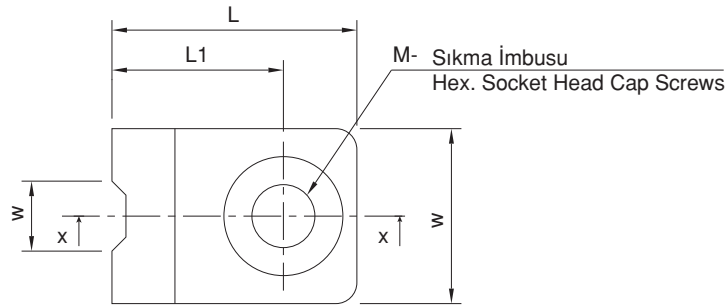
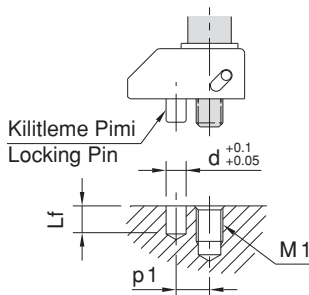
Uygulama Örneği / Application Example

Referans Nr.	M1	d	Lf	p1
2144-08015	M 8	6	8	10
2144-10019	M10	6	8	12
2144-12023	M12	8	11	16
2144-16025	M16	10	11	20

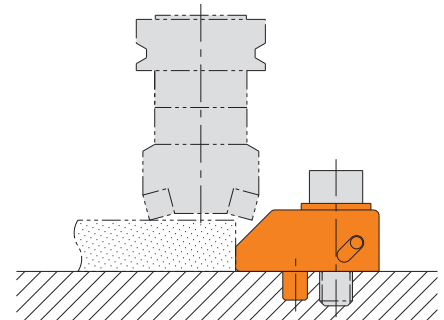

Referans Nr.		s1	m	sw	L	h	k	n	b	Sıkma Kuvveti Clamping Force	
										kgf	(g)
2150-08	8	1.4	5	4	23	9.5	6	7.7	13	310	25
2150-10	10	1.4	5	4	23	14	6	9.7	15	310	35
2150-12	12	1.2	7	5	28	15	7	11.7	18	340	60
2150-14	14	1.7	7	7	30	22	8	13.7	22	800	95
2150-16	16	1.7	10	8	30	22	9	15.7	25	1500	130
2150-18	18	2	10	8	35	28	10	17.7	28	1500	190
2150-20	20	2.5	13	10	40	32	12	19.7	32	2000	290
2150-22	22	2.5	13	12	45	38	14	21.7	35	2000	390

Ürün Nr. 2150 Kanal İçi Yandan Bağlama

- Ürünün T-Gövdesi tamamıyla tezgah kanalına girer. Sadece ürünün eksantrik başlığı tabla yüzeyinde kaldığı için ince parçalarda sıkma kolaylığı sağlar.
- DIN 650 T-Kanala uyumludur
- Sertleştirilmiş
- Siyah kaplama

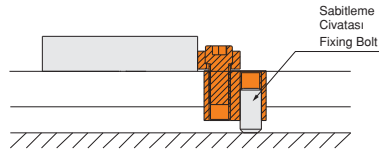
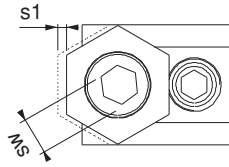
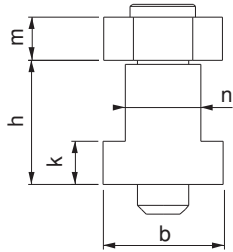

Product Nr. 2150 In-slot Side Clamp

- T-Slot of the product enters in the slot of the bench completely. Since only the eccentric headpiece remains on the surface of the table, this provides easy clamping of the thin pieces.
- It is in compliance with DIN 650 T-Slot
- Hardened
- Black coating



Yandan Bağlama Pençe Pabuç

Jaw Clamp

Referans Nr.		c	n		x	L	b	m1	sw	Sıkma Kuvveti Clamping Force		
			min	max						f1 kgf	f2 kgf	
2170-12	12	2	2	6	4	46	21	10	5	500	60	120
2170-14	14	2.5	2.5	7.5	5	51	26	10	6	550	70	200
2170-16	16	3	2.5	8.5	6	61	27.5	12	6	800	90	290
2170-18	18	3	2	8	6	67	35	13	8	900	100	420
2170-20	20	4	2.5	11	8.5	78	38	13	10	1200	140	640
2170-22	22	4.5	2.5	12	9.5	87	39	16.5	10	1600	190	830



Ürün Nr. 2170 Yandan Bağlama Pençe Pabuç

- İş parçasını dayama ve pleyt yönüne sıkar
- T-Kanal içinde çalışması yükseklik avantajı sağlar
- DIN 650 T-Kanala uyumludur
- Sertleştirilmiş
- Siyah kaplama

Product Nr. 2170 Jaw Clamp

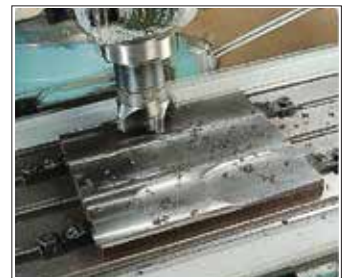
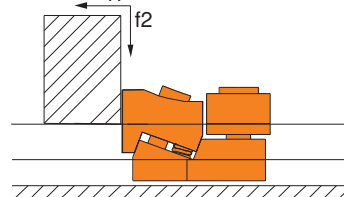
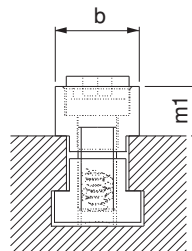
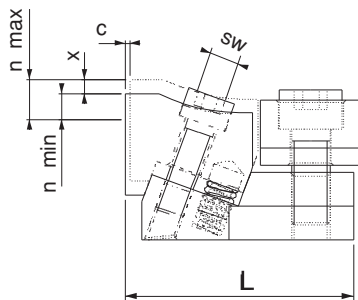
- This product clamps the workpiece in the direction of resting and plate
- It's working in T-Slot provides height advantage
- It is in compliance with DIN 650 T-Slot
- Hardened
- Black coating



Referans Nr.	c			m	k	b	L	e DIN 912	Sıkma Kuvveti Clamping Force kgf	
	min	max								
2190-5055	50	55	14-16-18-20-22	35	4	30	42	M12	1750	390

Ürün Nr. 2190 Çift Açılır Yandan Bağlama

- Bir noktadan iki yöne ve pleyt yönüne doğru sıkma işlemi yapar.
- M12 diş pleytlerde ve (a) 14-16-18-20-22 T-Kanal ölçülerinde kullanılır.
- Sertleştirilmiş
- Siyah kaplama

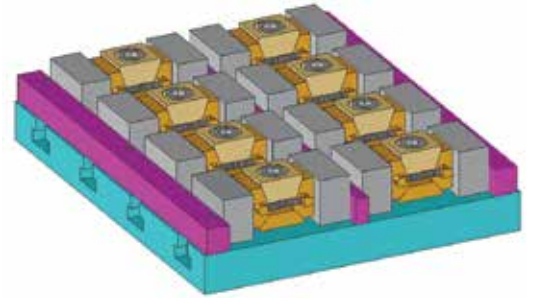
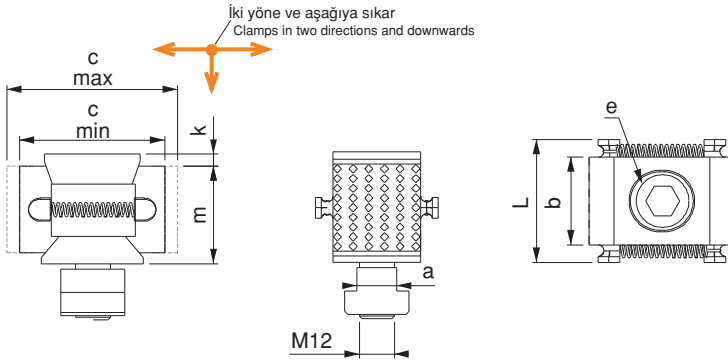

Product Nr. 2190 Side Press with Double Opening

- This product makes press process from one point to two directions and towards the direction of the plate.
- It is used in M12 thread plates and (a) 14-16-18-20-22 T-Slot measurings
- Hardened
- Black coating



Çift Açılır Yandan Bağlama

Side Press with Double Opening

Referans Nr.	c			m	k	b	L	e DIN 912	Sıkma Kuvveti Clamping Force kgf	
	min	max								
2210-4954	49	54	14-16-18-20-22	23	4	30	42	M12	1500	280

Ürün Nr. 2210 Çift Açılır Yandan Bağlama

- Bir noktadan iki yöne sıkma işlemi yapar.
- M12 diş pleytlerde ve (a) 14-16-18-20-22 T-Kanal ölçülerinde kullanılır.
- Sertleştirilmiş
- Siyah kaplama

Product Nr. 2210 Side Press with Double Opening

- This product makes press process from one point to two directions.
- It is used in M12 thread plates and (a) 14-16-18-20-22 T-Slot measurings
- Hardened
- Black coating

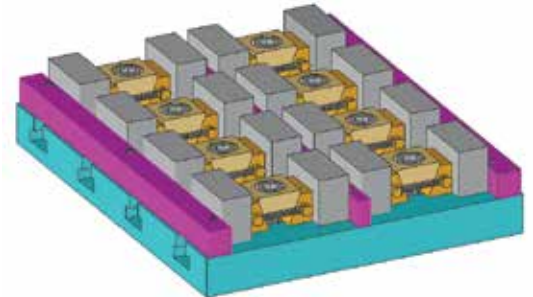
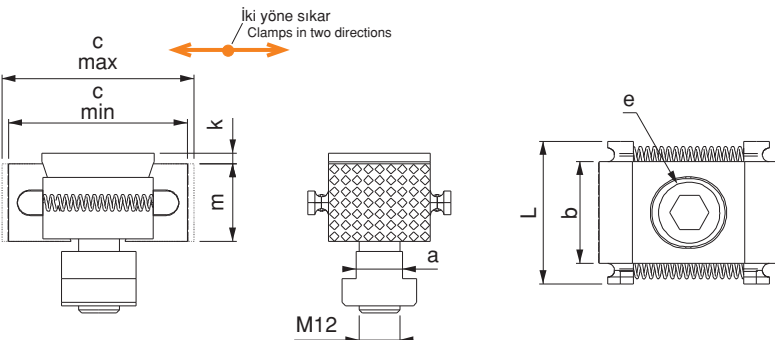

Referans Nr.	h x b x L	tolerans tolerance h	tolerans tolerance b	 (kg)	Adet Piece
2230-028	14x10x150	±0.01	±0.01	10.8	2
	16x10x150				2
	18x10x150				2
	20x10x150				2
	22x10x150				2
	24x10x150				2
	26x10x150				2
	28x10x150				2
	30x10x150				2
	32x10x150				2
	35x10x150				2
	40x10x150				2
	45x10x150				2
50x10x150	2				



Ürün Nr. 2230 Paralel Set-28

- Ürün iş parçalarının paralel bağlanmasında ve hassas işlenmesinde altlık olarak kullanılır.
- 28 parça
- Sertleştirilmiş
- Ahşap kutuda set

Product Nr. 2230 Paralel Set-28

- This product is used for parallel coupling of the workpieces and as the base for sensitive machinings of the work pieces.
- 28 pieces.
- Hardened
- Set is in the wooden box

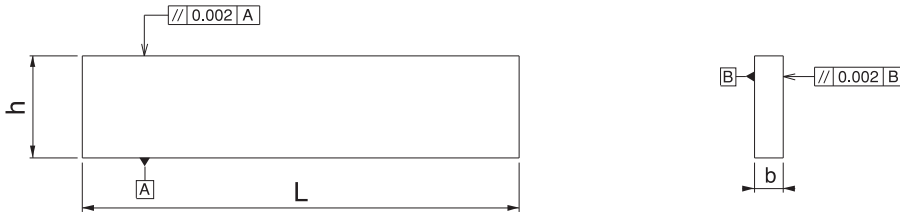

Paralel Set

Referans Nr.	h x b x L	tolerans tolerance h	tolerans tolerance b	 (kg)	Adet Piece
2250-016	20x6x100	±0.01	±0.01	10.6	2
	23x8x100				2
	28x10x100				2
	36x12x150				2
	42x14x150				2
	48x16x150				2
	58x18x150				2
	65x22x150				2





Ürün Nr. 2250 Paralel Set-16

- Ürün iş parçalarının paralel bağlanmasında ve hassas işlenmesinde altlık olarak kullanılır.
- 16 parça
- Sertleştirilmiş
- Ahşap kutuda set

Product Nr. 2250 Paralel Set-16

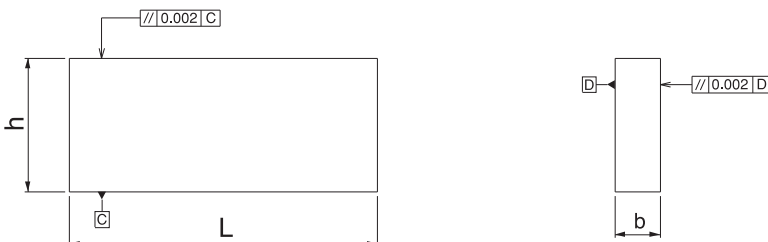
- This product is used for parallel coupling of the workpieces and as the base for sensitive machinings of the work pieces.
- 16 pieces.
- Hardened
- Set is in the wooden box



Referans Nr.	a	b	c	Øv		 (g)
				min	max	
2270-140	140	82	40	20	110	1980
2270-204	204	115	66	15	150	6150

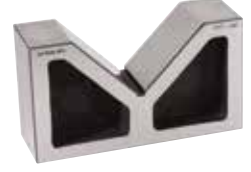



Ürün Nr. 2270 V-Yatak

- Malzeme : Döküm
- Silindir parçaların paralel bağlanmasında ve hassas işlenmesinde altlık olarak kullanılır.
- İkilili takım

Product Nr. 2270 V-Clamping Block

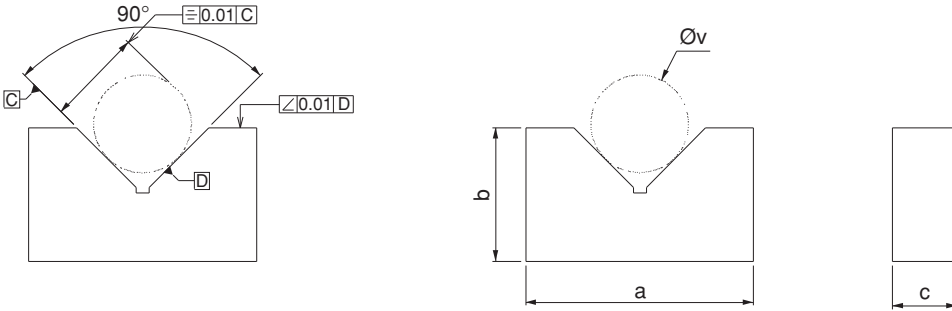
- Material: Casting
- This product is used in parallel couplings of cylindrical pieces and it is also used as the base for sensitive machinings of the workpieces.
- Set of two pieces



Referans Nr.	a	b	c	Øv1		Øv2		Øv3		Øv4		 (g)
				min	max	min	max	min	max	min	max	
2290-120	120	100	60	12	40	12	60	12	75	12	90	2840
2290-150	152	132	74	15	80	15	95	15	110	15	120	4975

XV-Yatak
XV-Clamping Block





Ürün Nr. 2290 XV-Yatak

- Malzeme : Döküm
- Silindir parçaların paralel bağlanmasında hassas işlenmesinde altlık olarak kullanılır, X formunda olmasından dolayı 4 ayrı yüzeyi kullanma avantajı sağlar.
- İkilili takım

Product Nr. 2290 XV-Clamping Block

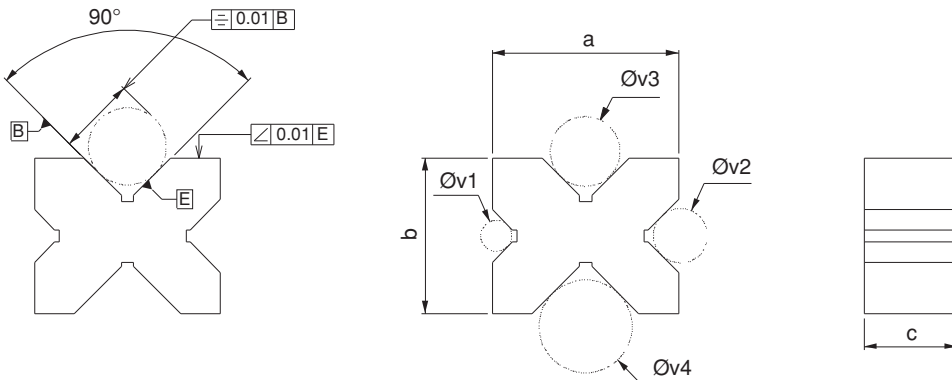
- Material: Casting
- This product is used in parallel couplings of cylindrical pieces and it is also used as the base for sensitive machinings of the workpieces. It provides using advantage in 4 different surfaces because of being in X form.
- Set of two pieces



Referans Nr.	L	h	a	a1	b	b1	sw	 (g)
2295-090	90	39	55	73	7	21-35	8	1480
2295-115	115	49	65	82.5	8.5	31-42	10	2690
2295-130	130	56	75	98	10	37-48	12	4160

Ürün Nr. 2295 CNC 5 Eksen Parça Bağlama Aparatı

- İş parçasına kırılmaç yuva açılarak aparata bağlanır.
- Sertleştirilmiş
- Siyah kaplama

Product Nr. 2295 CNC 5 Axis Clamping Parts Apparatus

- Apparatus is connected at workpiece, swallow nest opening.
- Hardened
- Black coating

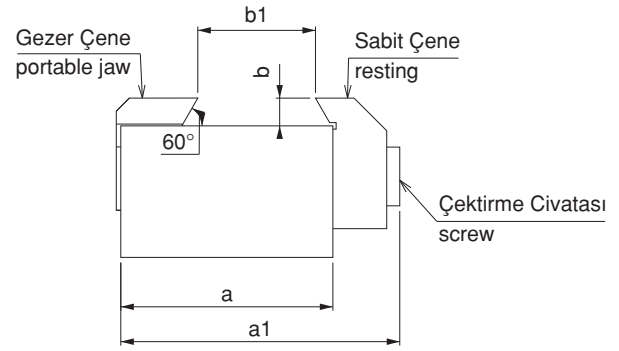
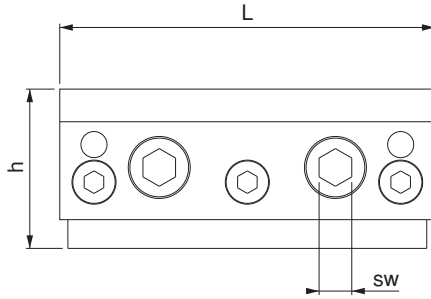

CNC 5 Eksen Parça Bağlama Takozu

Referans Nr.	a	h	L	d	 (g)
2297-090	55	58	87	M10	2110
2297-115	65	68	110	M12	3750
2297-130	75	80	126.5	M12	5830

Ürün Nr. 2297 CNC 5 Eksen Parça Bağlama Takozu

- Sertleştirilmiş
- Siyah kaplama

Product Nr. 2297 CNC 5 Axis Clamping Parts Wedge

- Hardened
- Black coating

