

IZELTAS®

TAKIM DOLAPLARI TAKIM ANTALARI VE ALET SETLERİ

TOOL TROLLEYS, TOOL BOXES AND
HAND TOOL SETS



Takim Dolapları
Tool Cabinets

Takim antaları
Tool Boxes

Servis Masaları
Service Tables

Alet Setleri
Tool Sets



8241 PRO SERİSİ / PRO SERIES

1

Pro Serisi Takım Dolabı (5-6-7-8 Çekmeceli)
Pro Series Workshop Trolley (5-6-7-8 Drawers)



✓ Merkezi kilit sistemi, mandal sistemi ve devrilme emniyet sistemi.
● Central lock system, handgrip lock system and antitilt system.



✓ Teleskobik rulmanlı kızaklar tüm çekmeceler %100 açılabilir.
● Telescopic slides which are %100 extendable.



✓ 8 bölmeli sağlam ve dayanıklı ABS plastik üst malzeme tabla.
● Durable ABS worktop with 8 divisions



✓ 2 sabit, 2 hareketli frenli tekerlek Ø 125mm
● 2 swivel castors with brake, 2 fixed castors Ø 125mm



✓ Yüksek dayanımlı elektrostatik toz boya.
● High strength electrostatic powder coating

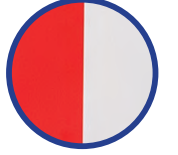

Ölçü/Size: 470x670x1007 mm

Sacdan imal edilmiş, Fırın boya
Made of sheet metal, Electrostatic paint

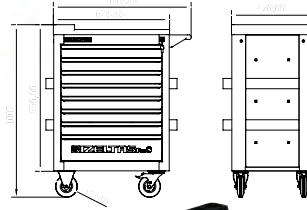

✓ Toplam 6 Adet yan ve arka avadanlık bölümleri.
● 6 tool holders



KOD/CODE	ÇEKMECE DRAWERS	35 kg	45 kg	45 kg	kg	RENK COLORS	FİYAT TL/Ad
8241 32 1005	5	1X	4X	--	59		2692,50
8241 32 1006	6	4X	1X	1X	62		2909,50
8241 32 1007	7	5X	2X	--	65	RAL 7035 RAL 3020	3438,35
8241 32 1008	8	7X	1X	--	67		3665,10
8241 32 2005	5	1X	4X	--	59		2692,50
8241 32 2006	6	4X	1X	1X	62	RAL 7035 RAL 5003	2909,50
8241 32 2007	7	5X	2X	--	65		3438,35
8241 32 2008	8	7X	1X	--	67		3665,10
8241 32 3005	5	1X	4X	--	59		2692,50
8241 32 3006	6	4X	1X	1X	62	RAL 7035 RAL 7016	2909,50
8241 32 3007	7	5X	2X	--	65		3438,35
8241 32 3008	8	7X	1X	--	67		3665,10
8241 00 1209 Dolu/Full 206 Parça/Pcs	8	7x	1x	--			8937,75

(★) İşaretili olan ürünler stoklarla sınırlıdır.
Limited with stocks.

1

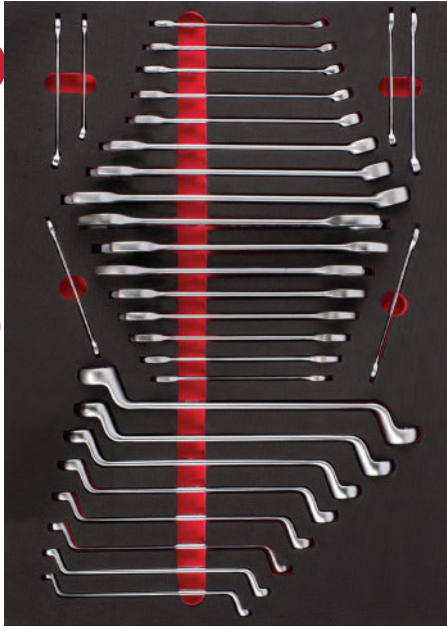

1

1. Pro Seri Çekmece/Drawer

Kod / Code 8241001030

KOD CODE	İÇERİK CONTENTS	□	FİYAT TL/Ad
0130	İki Ağız Anahtar Uzun Boy / D/E Open Jaw Wrench Long Pattern 6x7 - 8x9 - 10x11 - 12x13 14x15 - 16x17 - 18x19 - 20x22 21x23 - 24x26	10	
0330	Kombine Anahtar Uzun Boy / Combination Wrench Long Pattern 6 - 7 - 8 - 9 - 10 - 11 - 12 - 13 14 - 17 - 19 - 22	12	722,10
0430	Yıldız Anahtar / D/E Ring Wrench 6x7 - 8x9 - 10x11 - 12x13 14x15 - 16x17 18x19 - 20x22	8	

2



2. Pro Seri Çekmece/Drawer

Kod / Code 8241002072

KOD CODE	İÇERİK CONTENTS	□	FİYAT TL/Ad
1107	1/4" Altı Köşe Lokma Takımı / 1/4" Socket Wrench Set 4 - 5 - 6 7 - 8 - 9 - 10 11 - 12 - 13 Altı Köşe Six Point	15	
1113	1/4" Cırcır kolu / 1/4" Ratchet Handle 1/4" Mafsal / 1/4" Universal Joint 1/4" T Kol / 1/4" Sliding T Handle 1/4" Ara Kol / 1/4" Extension Bar 50 mm 1/4" Ara Kol / 1/4" Extension Bar 100 mm 1/2" Lokma Takımı / 1/2" Socket Wrench Set 1/2" Cırcır Kolu 32 Diş / 1/2" Ratchet Handle 1/2" Mafsal / 1/2" Universal Joint 1/2" T Kol Adaptör/ 1/2" Sliding T Handle Adapter 1/2" Ara Kol / 1/2" Extension Bar 125 mm 1/2" Ara Kol / 1/2" Extension Bar 250 mm	24	1422,20
1113	1/2" Lokmalı Allen Uçlar / 1/2" Hexagonal Bits Sockets H5-H6-H7-H8-H10-H12-H14	7	
1113	1/2" Lokmalı Star Uç / 1/2" Star Bits Socket T20-T25-T27-T30-T40-T45-T50-T55-T60	9	
0330	Kombine Anahtar Uzun Boy / Combination Wrench Long 16-18 mm	2	
4900	Allen Takımı 6 Köşe / Hex Key Wrench Set 2-2.5-3-3.5-4-5-6-7-8-9-10-12	12	

3



3. Pro Seri Çekmece/Drawer

Kod / Code 8241003051

KOD CODE	İÇERİK CONTENTS	□	FİYAT TL/Ad
07415	Sıralı Tel Fırça 3 Sıralı / Hand Brush 3 Raws	1	
6350	Levye Oluklu / Tyre Lever 400 mm	1	
6220	Spiralli Mıknatıs / Flexible Magnet Holder 500 gr	1	
4110	Düz Topaç Tornavida / Screwdriver , Stubby, Flat 6.5x25	1	
4130	Yıldız Topaç Tornavida / Screwdriver , Stubby, Phillips 6x25	1	617,75
4770	Lokma Uçlu Tornavida / Nutspinner 6-7-8-9-10-13	6	
4780	Manyetik Bits Tutucu Tornavida / Screwdriver, Magnetic Bit Holder 6.3x120	1	
4905	Yuvarlak Başlı Allen Takımı (Kutulu) / Hexkey Wrench Ballpoint Set 2-2.5-3-4-5-6-8-10 mm	8	
4800	Bits Set Takım (Kutulu) / Bits Set in metal case	31	

4. Pro Seri Çekmece/Drawer

Kod / Code 8241004027

1



4

KOD CODE	İÇERİK CONTENTS	☐	FİYAT TL/Ad
0340	Cırcır Kombine Anahtar / Combination Wrench With Ratchet 10-13-17-19 mm	4	
4909	T Tipi Torx Allen Anahtar / Torx Allen Key T type T9-T10-T15-T20-T25-T27-T30-T40	8	
1108	1/2" Altı Köşe Derin Lokma / 1/2" Deep Socket Wrench, six points 10-11-12-13-14-15-16-17-18-19	10	1060,55
1113	1/2" Altı Köşe Havalı Lokma / 1/2" Impact Socket Wrench 13-17-18-19-24 mm	5	

5. Pro Seri Çekmece/Drawer

Kod / Code 8241005010



5

KOD CODE	İÇERİK CONTENTS	☐	FİYAT TL/Ad
3331	İç Eğri Segman Pense / Circlip Pliers, Internal, Bent 170 mm	1	
3321	İç Düz Segman Pense / Circlip Pliers, Internal, Flat 180 mm	1	
3311	Dış Eğri Segman Pense / Circlip Pliers, External, Bent 170 mm	1	
3301	Dış Düz Segman Pense / Circlip Pliers, External, Flat 180 mm	1	
3700	Yan Keski Opak İzole / Side Cutting Pliers, 160 mm	1	939,45
3220	Düz Kargaburun Opak İzole / Nose Pliers, 200 mm	1	
3020	Kombine Pense Opak İzole / Combination Pliers, 180 mm	1	
2510	Special Ayarlı Pense / Special Grip 250 mm	1	
0600	Kurbağacık Anahtar / Adjustable Jaw Wrench 10"	1	
2400	Üniversal Fort Pense / Universal Grip 240 mm	1	

6. Pro Seri Çekmece/Drawer

Kod / Code 8241006018



6

KOD CODE	İÇERİK CONTENTS	☐	FİYAT TL/Ad
4300	Opak Seri Düz Uçlu Tornavida / Opak Screwdriver, Flat 4x100-5x125-6x150-8x175	4	
4320	Opak Seri Yıldız Uçlu Tornavida / Opak Screwdriver, Phillips 4.5x80-6x100	2	
5800	Tesviyeci Çekiç / Mechanist Hammer 300 gr	1	
5850	Plastik Çekiç / Plastic Hammer ø30	1	510,60
5545	Konik Pim Zimba / Drift Punch 5 mm	1	
5550	Düz Pim Zimba / Split Pin Punch 5 mm	1	
5540	Nokta Zimba / Center Punch 5x120	1	
5500	Düz Keski / Flat Cold Chisel 150 mm	1	
4920	T Tipi Allen Anahtar / T Type Hex Key Wrench 3-4-5-6-7-8	6	

(★) İşaretili olan ürünler stoklarla sınırlıdır.
Limited with stocks.

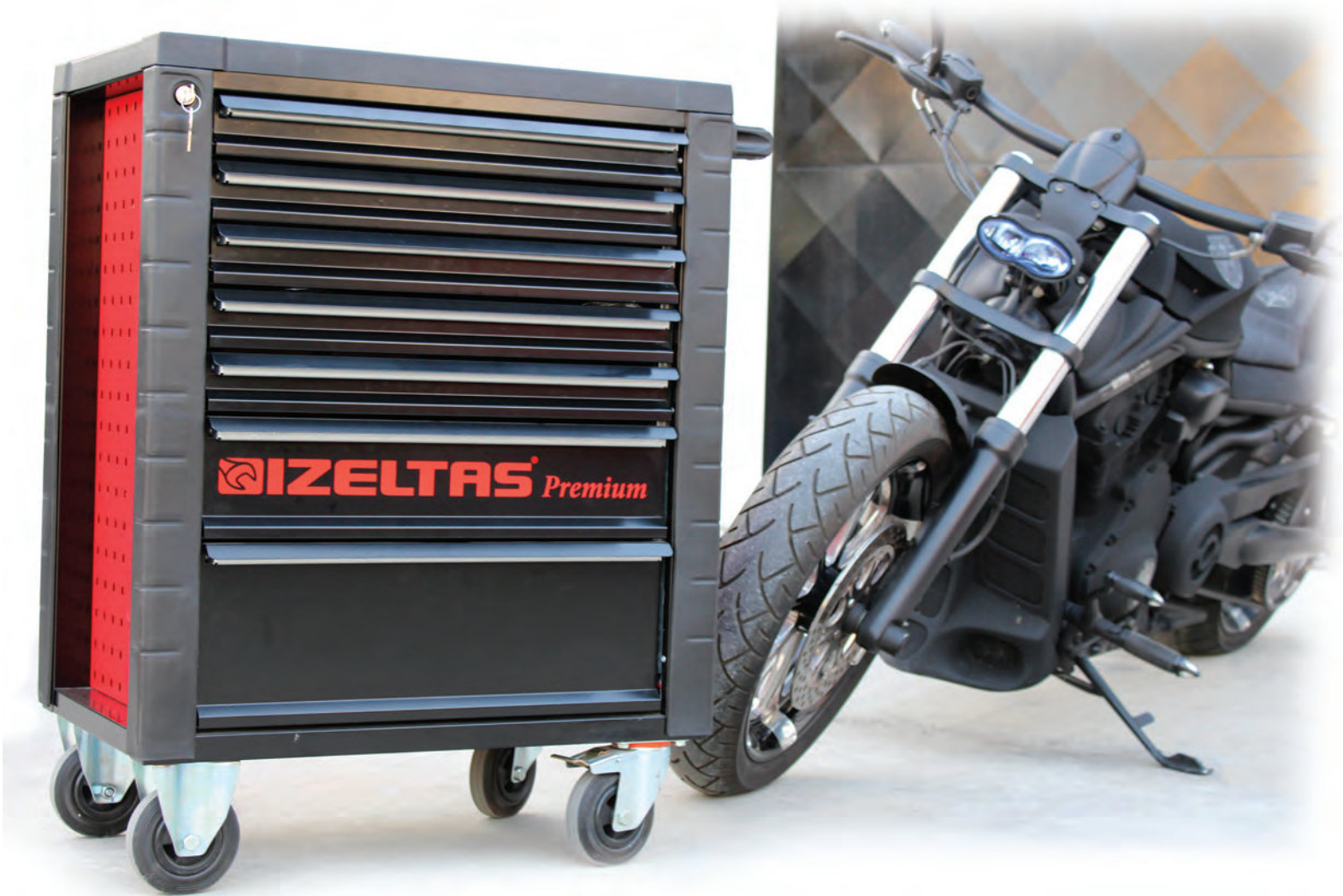

8245 PREMIUM SERİSİ / PREMIUM SERIES

Premium Serisi Takım Dolabı (5-7 Çekmeceli)
Premium Series Workshop Trolley (5-7 Drawers)



✓ 6 bölmeli sağlam ve dayanıklı ABS plastik üst malzeme tabla.
● Resistant and solid top cover having 6 divisions



✓ %100 açılabilir teleskobik raylar.
● %100 extendable telescopic slides



✓ Merkezi kilit
✓ Mandal sistemi
✓ Devrilme emniyet sistemi
● Central lock
● Handgrip Lock system
● Anti tilt system



✓ 2 sabit, 2 hareketli frenli tekerlek ø 125mm
● 2 swivel castors with brake
2 fixed castors ø 125mm



✓ Standard tutma sapı
● Standard handle



✓ Plastik köşe koruma
● Plastic corner protection



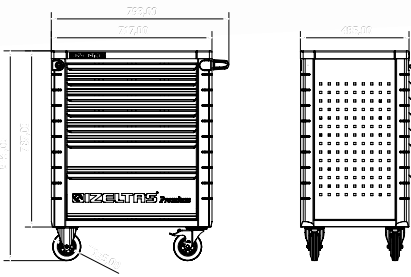

✓ Yüksek dayanımlı elektrostatik toz boya.
● High strength electrostatic powder coating.



Ölçü/Size: 485x717x944 mm

Sacdan imal edilmiş, Fırın boya
Made of sheet metal, Electrostatic paint



KOD/CODE	ÇEKMECE DRAWERS				Kg	RENK COLORS	FİYAT TL/Ad
8245 32 1005	5	400x548x62	400x548x132	400x548x201			2604,10
8245 32 1007	7					RAL 9005 RAL 3020	3371,25
8245 00 7096 Dolu/Full 242 Parça/Pcs	7						10408,20

1



1

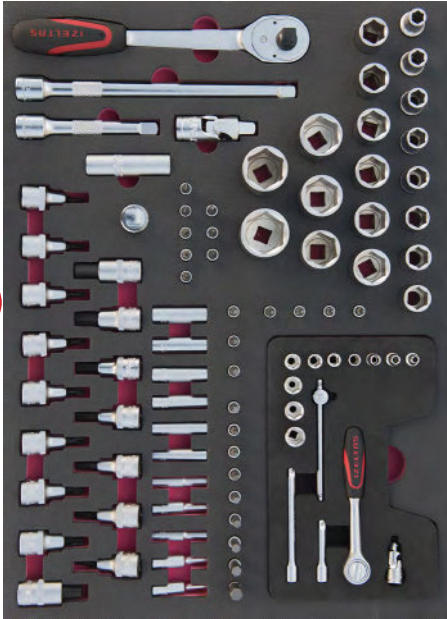

2



3

1. Premium Seri Çekmece/Drawer Kod / Code 8245001042

KOD CODE	İÇERİK CONTENTS	□	FIYAT TL/Ad
0100	İki Ağız Anahtar Kısa Boy D/E Open jaw wrenches Short Pattern 6x7-8x9-10x11-12x13-14x15-16x17-18x19-20x22	8	
0320	Kombine Anahtar Kısa Boy Combination wrenches Short Pattern 6-7-8-9-10-11-12-13-14-15-16-17-18-19-20-21-22-24-27-30-32	21	1345,80
0430	Yıldız Anahtar Ring Wrenches 6x7-8x9-10x11-12x13-14x15-16x17-18x19-20x22	8	
0340	Cırcır Kombine Anahtar / Combination Wrench With Ratchet 8-10-13-17-19 mm	5	

2. Premium Seri Çekmece/Drawer Kod / Code 8245002094

KOD CODE	İÇERİK CONTENTS	□	FIYAT TL/Ad
1107	1/4" Lokmalı Allen Uçlar / Hexagonal Bits Socket 2,5 - 3 - 4 - 5 - 6 - 7 - 8 - 10	8	
1107	1/4" Lokmalı Torx Uç / Torx Bits Socket T8-T9-T10-T15-T20-T25-T27-T30-T40	9	
1107	1/4" Lokmalı Yıldız Uç / Phillips Bits Socket PH1-PH2-PH3	3	
1107	1/4" Lokmalı Düz Uç / Slotted Bits Socket 3 - 4 - 5,5 - 6,5	4	
1107	1/4" Altı Köşe Derin Lokma / Deep Socket Wrench 6 Point 4-5-5,5-6-7-8-9-10-11-12-13	11	
1113	1/2" Lokmalı Allen Uç Takım / Hexagonal Bits Socket 5-6-7-8-10-12-14	7	
1113	1/2" Lokmalı Torx Uç Takım / Torx Bits Socket T20-T25-T27-T30-T40-T45-T50-T55-T60	9	
1107	4 - 5 - 6 7 - 8 - 9 - 10 11 - 12 - 13 Altı Köşe Six Points	15	1576,75
1113	1/4" Ara Kol / Extention Bar 50-100 mm 1/2" Buji Lokma Lastikli Spark Plug Socket With Rubber 16 mm 1/2" Lokma Takımı / Socket Wrench Set 1/2" Cırcır Kolu 32 Diş / Ratchet Handle 1/2" Mafsal / Universal Joint	1	
1113	10 - 11 - 12 - 13 14 - 15 - 16 - 17 18 - 19 - 21 - 22 23 - 24 - 26 - 27 28 - 30 - 32 Altı Köşe Six Points	24	
	1/4" T Kol / Sliding T Handle 1/2" T Kol Adaptör / Sliding T Handle Adapter 1/2" Ara Kol / Extension Bar 125 mm 1/2" Ara Kol / Extension Bar 250 mm		

3. Premium Seri Çekmece/Drawer Kod / Code 8245003014

KOD CODE	İÇERİK CONTENTS	□	FIYAT TL/Ad
3700	Yan Keski Opak İzole / Side Cutting Pliers 160 mm	1	
3020	Kombine Pense Opak İzole / Combination Pliers 180 mm	1	
3220	Düz Kargaburun Opak İzole / Nose Pliers Flat 180 mm	1	
4300	Opak Seri Düz Uçlu Tornavida / Screwdriver, Flat 3x80-5x125-7x150mm	3	
4320	Opak Seri Yıldız Uçlu Tornavida / Screwdriver, Phillips 3x60-4.5x80-6x100-8x150mm	4	704,85
3301	Dış segman Pensi Yaylı Düz / Circlip Pliers, External Flat 140-180mm	2	
3321	İç segman Pensi Yaysız Düz / Circlip Pliers, Internal Flat 140-180mm	2	

4. Premium Seri Çekmece/Drawer Kod / Code 8245004043

KOD CODE	İÇERİK CONTENTS	☐	FİYAT TL/Ad
4770	Lokma Uçlu Tornavida / Nutspinner 6-7-8-9-10-13	6	775,65
4910	Torx Allen Takım / Torx Key Wrench Set T9-T10-T15-T20-T25-T27-T30-T40	8	
4900	Allen Takımı 6 Köşe / Hex Key Wrench Set 2-2.5-3-3.5-4-5-6-7-8-9-10-12	12	
4906	Yuvarlak Başlı Uzun Allen Takımı / Hex key Wrench Ballpoint Long Pattern Set 1,5-2-2,5-3-4-5-6-8-10 mm	9	
4920	T Tipi Allen Anahtar / T Type Hex Key Wrench 2.5-3-4-5-6-7-8-10	8	

5. Premium Seri Çekmece/Drawer Kod / Code 8245005043

KOD CODE	İÇERİK CONTENTS	☐	TL/Ad.
4565	Oto Elektrik Kontrol Kalemi Car Voltage Tester 135mm	1	853,00
07415	Sıralı Tel Fırça 4 Sıralı / Hand Brush 4 Raws	1	
2400	Üniversal Fort Pense PVC / Universal Grip 240 mm	1	
2500	Üniversal Ayarlı Pense Universal Grip 250 mm	1	
0600	Kurbağacık Anahtar / Adjustable Wrench 10"	1	
4780	Manyetik Bits Tutucu Tornavida / Screwdriver, Magnetic Bit Holder 6.3x120	1	
4800	31'li Bits Takım (Plastik Kutulu) / Bits Set in plastic case	31	
4110	Düz Topaç Tornavida / Screwdriver, Stubby, Flat 6.5x25	1	
4130	Yıldız Topaç Tornavida / Screwdriver, Stubby, Phillips 6x25	1	
5500	Düz Keski Krom Flat Cold Chisel 150 mm	1	
5800	Tesviyeci Çekici Machinist's Hammer 300-1500 gr	2	
6350	Levye Oluklu / Tyre Lever 500 mm	1	

6. Premium Seri Çekmece/Drawer Kod / Code 8245006009

KOD CODE	İÇERİK CONTENTS	☐	FİYAT TL/Ad
1855	Mafsallı T Kol Lokma T- Handle Wrench with Universal Join 8-10-12-13-17-19	6	1780,90
6230	Gres Pompası Grease Gun 500cc	1	
06375	Ayarlı Yağ Filtre Sökeceği Adjustable Slot Type Oil Filter Wrench	1	
6225	Madeni Yağdanlık (Flexible Uçlu) Oiler With Flexible Spout 200cc	1	

(★) İşaretili olan ürünler stoklarla sınırlıdır.
Limited with stocks.



8242 GARAJ SERİSİ / GARAGE SERIES

Garaj Serisi Takım Dolabı (5-6-7-8 Çekmeceli)
Garage Series Workshop Trolley (5-6-7-8 Drawers)

1



✓ Ergonomik sap
● Ergonomic handle



✓ 8 Bölmeli, sağlam ABS tabla
● Durable ABS worktop with divisions



✓ Havluluk x1
Avadanlık x2 Askılık x1
● Paper Roll Holder
x1 Bottle & Tins Holder x2 Hanger x1



✓ %100 açılabilir teleskobik raylar
● %100 extendable telescopic slides



✓ Merkezi kilit sistemi, mandal sistemi devrilme emniyet sistemi.
● Central locking, system handgrip lock system antitilt system



✓ 2 sabit, 2 hareketli frenli tekerlek Ø 125mm
● 2 swivel castors with brake 2 fixed castors Ø 125 mm



✓ Yüksek dayanımlı elektrostatik toz boya.
● High strength electrostatic powder coating

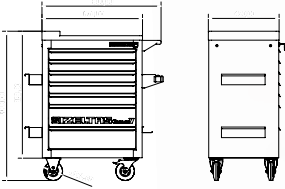

Ölçü/Size: 470x670x1010 mm

Sacdan imal edilmiş, Fırın boya
Made of sheet metal, Electrostatic paint



KOD/CODE	ÇEKMECE DRAWERS	35 kg	45 kg	45 kg	kg	RENK COLORS	FİYAT TL/Ad
		400x548x68	400x548x143	400x548x218			
8242 32 1005	5	1X	4X	--	59		2405,85
8242 32 1006	6	4X	1X	1X	62	RAL 7016	2831,85
8242 32 1007	7	5X	2X	--	65	RAL 3020	3308,70
8242 32 1008	8	7X	1X	--	67		3632,20
8242 32 2005	5	1X	4X	--	59		2405,85
8242 32 2006	6	4X	1X	1X	62	RAL 7016	2831,85
8242 32 2007	7	5X	2X	--	65	RAL 5003	3308,70
8242 32 2008	8	7X	1X	--	67		3632,20
8242 32 3005	5	1X	4X	--	59		2405,85
8242 32 3006	6	4X	1X	1X	62	RAL 7016	2831,85
8242 32 3007	7	5X	2X	--	65	RAL 7035	3308,70
8242 32 3008	8	7X	1X	--	67		3632,20
8242 00 1142 Dolu/Full 139 Parça/Pcs	7	5X	2X	--			7303,45
8242 00 8142 Dolu/Full 139 Parça/Pcs	8	7X	1X	--			7626,95

(★) İşaretili olan ürünler stoklarla sınırlıdır.
Limited with stocks.

1

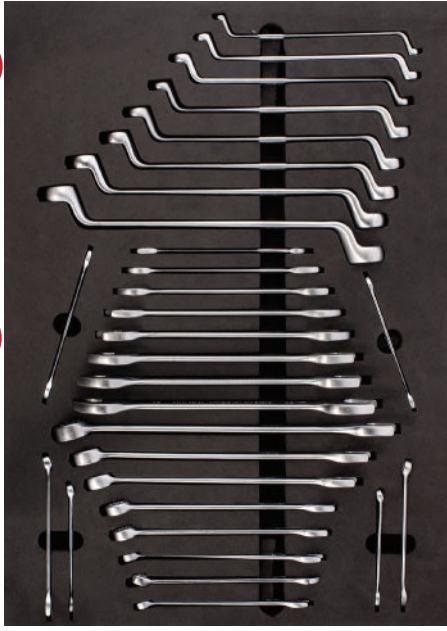

1

1. Garaj Seri Çekmece/Drawer

Kod / Code 8242001030

KOD CODE	İÇERİK CONTENTS	□	FİYAT TL/Ad
0130	İki Ağız Anahtar Uzun Boy D/E Open Jaw Wrench Long Pattern 6x7 - 8x9 - 10x11 - 12x13 14x15 - 16x17 - 18x19 - 20x22 - 21x23 - 24x26	10	
0330	Kombine Anahtar Uzun Boy Combination Wrenches Long Pattern 6 - 7 - 8 - 9 - 10 - 11 - 12 - 13 - 14 - 17 - 19 - 22	12	722,10
0430	Yıldız Anahtar Ring Wrench 6x7 - 8x9 - 10x11 - 12x13 - 14x15 - 16x17 18x19 - 20x22	8	

2. Garaj Seri Çekmece/Drawer

Kod / Code 8242002072

KOD CODE	İÇERİK CONTENTS	□	FİYAT TL/Ad
1113	1/2" Lokmalı Allen Uçlar Hexagonal Bits Socket H5-H6-H7-H8-H10-H12-H14	7	
1113	1/2" Lokmalı Star Uç / 1/2 Star Bits Socket T20-T25-T27-T30-T40-T45-T50-T55-T60	9	
0330	Kombine Anahtar Uzun Boy Combination Pliers Long 16-18 mm	2	
4900	Allen Takımı Altı Köşe / Hex Key Wrench Set 2-2.5-3-3.5-4-5-6-7-8-9-10-12	12	
1107	1/4" Altı Köşe Lokma Takımı Socket Wrench Set 1/4" Cırcır Kolu Ratchet Handle 1/4" Mafsal Universal Joint 1/4" T Kol / Sliding T Handle 1/4" Ara Kol / Extension Bar 50 mm 1/4" Ara Kol Extension Bar 100 mm 1/2" Lokma Takımı Socket Wrench Set 1/2" Cırcır Kolu 32 Diş Ratchet Handle 1/2" Mafsal Universal Joint 1/2" T Kol Adaptör Sliding T Handle Adapter 1/2" Ara Kol Extension Bar 125 mm 1/2" Ara Kol Extension Bar 250 mm	15	1422,20
1113	4 - 5 - 6 7 - 8 - 9 - 10 11 - 12 - 13 Altı Köşe Six Points 10 - 11 - 12 13 - 14 - 15 16 - 17 - 18 19 - 21 - 22 23 - 24 - 26 27 - 28 - 30 32 Altı Köşe Six Points	24	

2



3. Garaj Seri Çekmece/Drawer

Kod / Code 8242003010

1



KOD CODE	İÇERİK CONTENTS	☐	FİYAT TL/Ad
3331	İç Eğri Segman Pense Circlip Pliers Internal (Bent) 170 mm	1	
3321	İç Düz Segman Pense Circlip Pliers Internal (Flat) 180 mm	1	
3311	Dış Eğri Segman Pense Circlip Pliers External (Bent) 170 mm	1	
3301	Dış Düz Segman Pense Circlip Pliers External (Flat) 180 mm	1	
3700	Yan Keski Opak İzole Side Cutting Pliers 160 mm	1	939,45
3220	Düz Kargaburun Opak İzole Nose Pliers (Flat) 200 mm	1	
3020	Kombine Pense Opak İzole Combination Pliers 180 mm	1	
2510	Special Ayarlı Pense / Universal Grip 250 mm	1	
0600	Kurbağacık Anahtar / Adjustable Wrench 10"	1	
2400	Üniversal Fort Pense / Waterpump Pliers Üniversal 240 mm	1	

4. Garaj Seri Çekmece/Drawer

Kod / Code 8242004018



KOD CODE	İÇERİK CONTENTS	☐	FİYAT TL/Ad
4300	Opak Seri Düz Uçlu Tornavida Screwdriver, Opak Flat 5x125-4x100-6x150-8x175	4	
4320	Opak Seri Yıldız Uçlu Tornavida Screwdriver, Opak Phillips 4.5x80-6x100	2	
5800	Tesviyeci Çekiç Machinist's Hammer 300 gr	1	
5850	Plastik Çekiç Plastic Hammer ø30	1	510,60
5545	Konik Pim Zimba Drift Punch 5 mm	1	
5550	Düz Pim Zimba Split Pin Punch 5 mm	1	
5540	Nokta Zimba Center Punch 5x120	1	
5500	Düz Keski Flat Cold Chisel 150 mm	1	
4920	T Tipi Allen Anahtar / Hex Key Wrench 3-4-5-6-7-8	6	

5. Garaj Seri Çekmece/Drawer

Kod / Code 8242005011



KOD CODE	İÇERİK CONTENTS	☐	FİYAT TL/Ad
07415	Sıralı Tel Fırça 3 Sıralı Hand Brush 3 Raws	1	
6350	Levye Oluklu Tyre Lever, Straight 400 mm	1	
6220	Spiralli Mıknatıs Flexible Magnet Holder 500 gr	1	
4110	Düz Topaç Tornavida Screwdriver Stubby Flat 6.5x25	1	400,40
4130	Yıldız Topaç Tornavida Screwdriver Stubby Phillips 6x25	1	
4770	Lokma Uçlu Tornavida Nut Spinner 6-7-8-9-10-13	6	



8235 PARTNER SERİSİ / PARTNER SERIES

1

Partner Mobil Takım Dolabı (5 Çekmeceli)
Partner Workshop Trolley (5 Drawers)



- ✓ Merkezi kilit.
● Central lock system



- ✓ %100 açılabilir, kendinden frenli teleskobik ray
● %100 extendable telescopic soft close slides



- ✓ 8 Bölmeli, sağlam ABS tabla
● 8 Durable ABS worktop with divisions



- ✓ 2 sabit, 2 hareketli frenli tekerlek ø 100mm
● 2 swivel castors with brake
2 fixed castors ø 100 mm

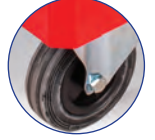

- ✓ Yüksek dayanımlı elektrostatik toz boya.
● High strength electrostatic powder coating



Ölçü/Size: 470x670x975 mm

Sacdan imal edilmiş, Fırın boya
Made of sheet metal, Electrostatic paint

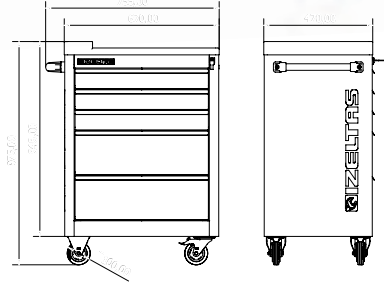

RAL 3020



RAL 5003



RAL 9005

KOD/CODE	ÇEKMECE DRAWERS	35 kg	45 kg	kg	RENK COLORS	FİYAT TL/Ad
		350x550x75	400x550x180			
8235 32 6005	5	3X	2X	56	RAL 3020	2188,85
8235 32 5005	5	3X	2X	56	RAL 5003	2188,85
8235 32 7005	5	3X	2X	56	RAL 9005	2188,85
8235 00 6121 Dolu/Full 118 Parça/Pcs	5	3X	2X			5148,90

1



1



1. Partner Seri Çekmece/Drawer

Kod / Code 8235001072

KOD CODE	İÇERİK CONTENTS	□	FİYAT TL/Ad
1107	<p>1/4" Altı Köşe Lokma Takımı 1/4" Socket Wrench Set</p> <p>1/4" Cırcır kolu Ratchet Handle</p> <p>1/4" Mafsalsal Universal Joint</p> <p>1/4" T Kol Sliding T Handle</p> <p>1/4" Ara Kol Extention Bar 50 mm</p> <p>1/4" Ara Kol Extention Bar 100 mm</p> <p>4 - 5 - 6 7 - 8 - 9 - 10 11 - 12 - 13 Altı Köşe Six Points</p>	15	
1113	<p>1/2" Lokma Takımı 1/2" Socket Set</p> <p>1/2" Cırcır Kolu 32 Diş Ratchet Handle</p> <p>1/2" Mafsalsal Universal Joint</p> <p>1/2" T Kol Adaptör Sliding T Handle Adapter</p> <p>1/2" Ara Kol Extention Bar 125 mm</p> <p>1/2" Ara Kol Extention Bar 250 mm</p> <p>10 - 11 - 12 - 13 14 - 15 16 - 17 - 18 19 - 21 - 22 23 - 24 - 26 - 27 - 28 30 - 32</p>	24	1577,35
1507	<p>1/4" Derin Lokma Tornavida Adaptörü Spindle Handle</p>	1	
4900	<p>12 'li Allen Anahtar Takımı Hex Key Wrench Set 2-2.5-3-3.5-4-5-6-7-8-9-10-12 mm</p>	12	
4910	<p>8 'li Torx Allen Anahtar Takımı Torx Key Wrench 6 Point T9-T10-T15-T20-T25-T27-T30-T40</p>	8	
1108	<p>1/2" Altı Köşe Derin Lokma Deep Socket Wrench 6 Point 10-13-16-17-18-19 mm</p>	6	
1113	<p>1/2" 16 mm Buji Lokma Anahtar Spark Plug Socket With Rubber</p>	1	
2400	<p>240 mm Üniversal Fort Pense Waterpump Pliers, Universal</p>	1	
2500	<p>250 mm Üniversal Ayarlı Pense Universal Grip</p>	1	

2. Partner Seri Çekmece/Drawer

Kod / Code 8235002031

1

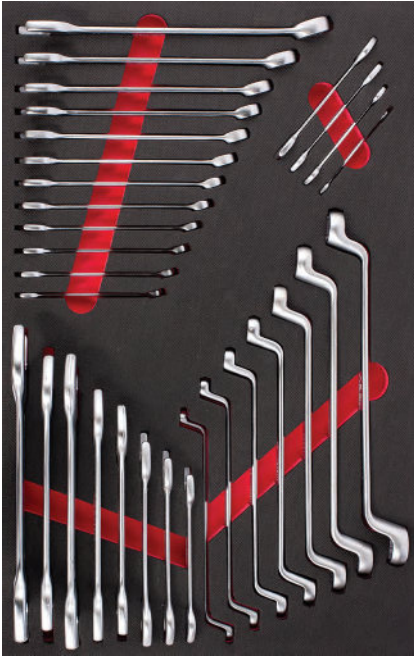

KOD CODE	İÇERİK CONTENTS	□	FİYAT TL/Ad
0100	İki Ağız Anahtar Kısa Boy Double Ended Open Jaw Wrench Short Pattern 6x7 - 8x9 - 10x11 - 12x13 14x15 - 16x17 - 18x19 - 20x22 21x23 - 24x26 - 25x28 - 30x32	12	716,00
0320	Kombine Anahtar Kısa Boy Combination Wrench Short Pattern 8 - 9 - 10 - 11 - 12 - 13 14 - 15 -16- 17 - 19 - 22	12	
0430	Yıldız Anahtar Ring Wrench 8x9 - 10x11 - 12x13 - 14x15 - 16x17 18x19 - 20x22	7	

2



3

3. Partner Seri Çekmece/Drawer

Kod / Code 8235003017

KOD CODE	İÇERİK CONTENTS	□	FİYAT TL/Ad
4300	Opak Seri Düz Uçlu Tornavida Screwdriver, Opak Flat 3x80-4x80-4x100-5x125-6x150	5	666,70
4320	Opak Seri Yıldız Uçlu Tornavida Screwdriver, Opak Philips 4.5x80-6x100	2	
3700	Yan Keski Opak İzole Side Cutting Pliers 160 mm	1	
3020	Kombine Pense Opak İzole Combination Pliers 180 mm	1	
3220	Düz Kargaburun Opak İzole Nose Pliers Flat 200 mm	1	
4770	Lokma Uçlu Tornavida Nut Spinner 6-7-8-10-13	5	
5500	Düz Keski Flat Cold Chisel 150 mm	1	
5800	Tesviyeci Çekiçi Machinist's Hammer 500 gr	1	



1

Eko Serisi Takım Dolabı (5-7 Çekmeceli)
Eco Series Workshop Trolley (5-7 Drawers)

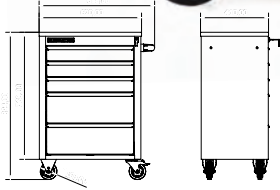

Ölçü/Size: 410x620x894 mm



RAL 7016
RAL 3020



RAL 7016
RAL 5003



RAL 7035
RAL 7016

✓ 4 bölmeli sağlam ve dayanıklı ABS plastik üst malzeme tabla.
● Resistant and solid top cover with 4 divisions



✓ %100 açılabilir teleskobik raylar.
● %100 extendable telescopic slides



✓ Merkezi kilit
● Central locking



✓ 2 sabit, 2 hareketli frenli tekerlek ø 100 mm
● 2 swivel castors with brake
2 fixed castors ø 100 mm





✓ Yüksek dayanımlı elektrostatik toz boya.
● High strength electrostatic powder coating

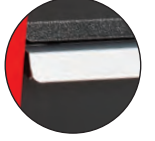

✓ Elokсалlı alüminyum tutma çantası.
● Handle with anodised aluminum



Sacdan imal edilmiş, Fırın boya
Made of sheet metal, Electrostatic paint

KOD/CODE	ÇEKMECE DRAWERS	 35 kg	 45 kg	Kg	RENK COLORS	FİYAT TL/Ad
		350x503x82	400x503x176			
8243 32 1005	5	3X	2X	43	RAL 7016 RAL 3020	1596,75
8243 32 1007	7	7X	--	43		2140,70
8243 32 2005	5	3X	2X	43	RAL 7016 RAL 5003	1596,75
8243 32 2007	7	7X	--	43		2140,70
8243 32 3005	5	3X	2X	43	RAL 7035 RAL 7016	1596,75
8243 32 3007	7	7X	--	43		2140,70
8243 00 1096	5	3X	2X			3946,45
Dolu/Full 93 Parça/Pcs						
8243 00 7096	7	3x	--			4490,40
Dolu/Full 93 Parça/Pcs						

(★) İşaretili olan ürünler stoklarla sınırlıdır.
Limited with stocks.

1. Eko Seri Çekmece/Drawer

Kod / Code 8243001030

1

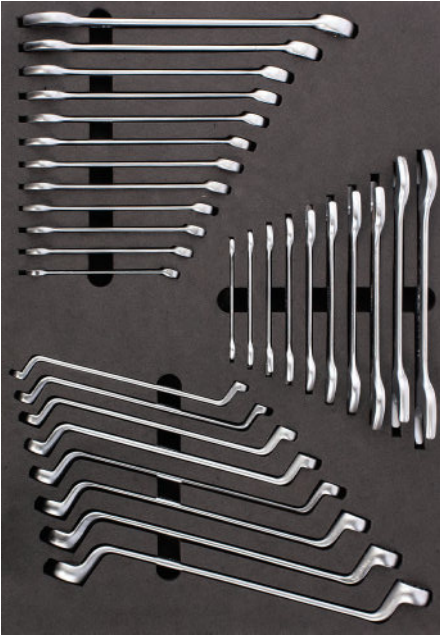

KOD/CODE	İÇERİK CONTENTS	☐	TL/Ad.
0100	İki Ağız Anahtar Kısa Boy D/E Open Jaw Wrench Short Pattern 6x7 - 8x9 - 10x11 - 12x13 14x15 - 16x17 - 18x19 - 20x22 - 21x23 - 24x26	10	
0320	Kombine Anahtar Kısa Boy Combination Wrench Short Pattern 8 - 9 - 10 - 11 - 12 - 13 - 14 - 15 - 16 - 17 - 19 - 22	12	677,50
0430	Yıldız Anahtar Ring Wrench 6x7 - 8x9 - 10x11 - 12x13 - 14x15 - 16x17 18x19 - 20x22	8	

2. Eko Seri Çekmece/Drawer

Kod / Code 8243002052



KOD/CODE	İÇERİK CONTENTS	☐	TL/Ad.
1113	1113 1/2" 17'li Lokma Takımı Socket Wrench Set 1/2" mm 10 - 11 - 12 - 13 - 14 - 15 - 17 - 19 22 - 24 - 27 - 30 - 32 250 - 250 - 70	17	
1107	1/2" T Kol Adaptör Sliding T Handle Adapte		
1107	1/4" Altı Köşe Lokma Takımı Socket Wrench Set 1/4" mm 4 - 5 - 6 - 7 - 8 - 9 - 10 - 11 - 12 - 13 140 - 115 - 100 - 50 - 38	15	1003,65
4900	Allen Anahtar Takımı Hex Key Wrench Set 2 - 2.5 - 3 - 3.5 - 4 - 5 - 6 - 7 - 8 - 9 - 10 - 12	12	
4770	Lokma Uçlu Tornavidalar Nutspinners 6 - 7 - 8 - 10 - 13	5	

3. Eko Seri Çekmece/Drawer

Kod / Code 8243003013



KOD/CODE	İÇERİK CONTENTS	☐	TL/Ad.
4320	Opak Yıldız Uçlu Tornavida Opak Screwdriver, Phillips 4,5x80-6x100 mm	2	
4300	Opak Düz Uçlu Tornavida Opak Screwdriver, Flat 4x100-5x125-6x150-8x175 mm	4	
3700	Yan Keski Opak Side Cutting Pliers 160 mm	1	
3020	Kombine Pense Opak Combination Pliers 180 mm	1	
3220	Kargaburun Düz Uçlu Opak Nose Pliers, Flat 160 mm	1	668,55
5500	Düz Keski Krom Flat Cold Chisel 150 mm	1	
5800	Tesviyeci Çekici Machinist's Hammer 300 gr	1	
2510	Spesiyel Ayarlı Pense / Waterpump Pliers Special 250 mm	1	
2400	Üniversal Fort Pense PVC / Universal Grip 240 mm	1	

1

Trend Serisi Takım Dolabı (5-7 Çekmeceli) Trend Series Workshop Trolley (5-7 Drawers)



✓ 4 bölümlü sağlam ve dayanıklı ABS plastik üst malzeme tabla.
● Resistant and solid top cover with 4 divisions

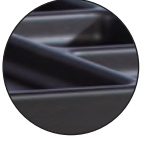

✓ %100 açılabilir teleskobik raylar.
● %100 extendable telescopic slides

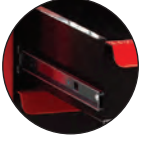

✓ Merkezi kilit
● Central locking



✓ 2 sabit, 2 hareketli frenli tekerlek ø 100 mm
● 2 swivel castors with brake
2 fixed castors ø 100 mm



✓ Yüksek dayanımlı elektrostatik toz boya
● High strength electrostatic powder coating





✓ Kendiliğinden açılmayı engelleyen plastik kilit
● Plastic lock preventing self opening

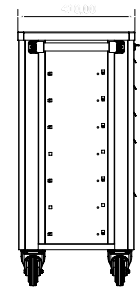
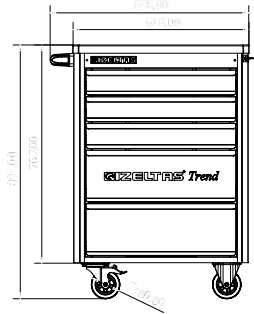

Ölçü/Size: 410x618x894 mm



Sacdan imal edilmiş, Fırın boya
Made of sheet metal, Electrostatic paint

KOD/CODE	ÇEKMECE DRAWERS	 350x503x82	 400x503x176	 Kg	RENK COLORS	FİYAT TL/Ad
8244 32 1005	5	3X	2X	43	RAL 9005 RAL 3020	1268,70
8244 32 1007	7	7X	--	43		1669,25
8244 00 5096 Dolu/Full 93 Parça/Pcs	5	3X	2X			3618,40
8244 00 7096 Dolu/Full 93 Parça/Pcs	7	7X	--			4018,95

1. Trend Seri Çekmece/Drawer

Kod / Code 8244001030

1

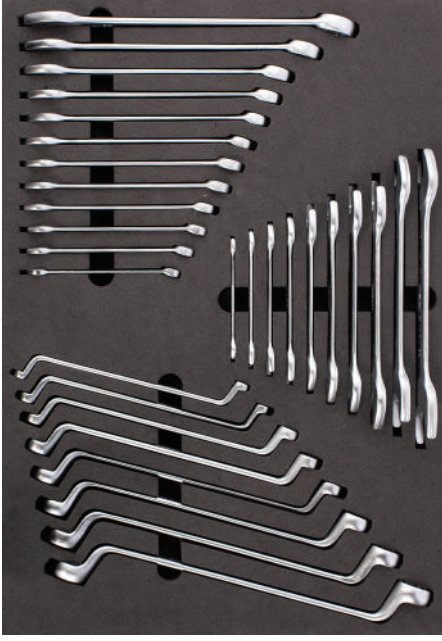

KOD/CODE	İÇERİK CONTENTS	☐	TL/Ad.
0100	İki Ağız Anahtar Kısa Boy D/E Open Jaw Wrench Short Pattern 6x7 - 8x9 - 10x11 - 12x13 14x15 - 16x17 - 18x19 - 20x22 - 21x23 - 24x26	10	677,50
0320	Kombine Anahtar Kısa Boy Combination Wrench Short Pattern 8 - 9 - 10 - 11 - 12 - 13 - 14 - 15 - 16 - 17 - 19 - 22	12	
0430	Yıldız Anahtar Ring Wrench 6x7 - 8x9 - 10x11 - 12x13 - 14x15 - 16x17 18x19 - 20x22	8	

2. Trend Seri Çekmece/Drawer

Kod / Code 8244002052



KOD/CODE	İÇERİK CONTENTS	☐	TL/Ad.
1113	1/2" 17'li Lokma Takımı Socket Wrench Set 1/2" mm 10 - 11 - 12 - 13 - 14 - 15 - 17 - 19 22 - 24 - 27 - 30 - 32 250 - 250 - 70	17	1003,65
1107	1/4" Altı Köşe Lokma Takımı Socket Wrench Set 1/4" mm 4 - 5 - 6 - 7 - 8 - 9 - 10 - 11 - 12 - 13 140 - 115 - 100 - 50 - 38	15	
4900	Allen Anahtar Takımı Hex Key Wrench Set 2 - 2.5 - 3 - 3.5 - 4 - 5 - 6 - 7 - 8 - 9 - 10 - 12	12	
4770	Lokma Uçlu Tornavidalar Nutspinners 6 - 7 - 8 - 10 - 13	5	

3. Trend Seri Çekmece/Drawer

Kod / Code 8244003013



KOD/CODE	İÇERİK CONTENTS	☐	TL/Ad.
4320	Opak Yıldız Uçlu Tornavida Opak Screwdriver, Phillips 4.5x80-6x100 mm	2	668,55
4300	Opak Düz Uçlu Tornavida Opak Screwdriver, Flat 4x100-5x125-6x150-8x175 mm	4	
3700	Yan Keski Opak Side Cutting Pliers 160 mm	1	
3020	Kombine Pense Opak Combination Pliers 180 mm	1	
3220	Kargaburun Düz Uçlu Opak Nose Pliers, Flat 160 mm	1	
5500	Düz Keski Krom Flat Cold Chisel 150 mm	1	
5800	Tesviyecici Çekici Machinist Hammer 300 gr	1	
2510	Special Ayarlı Pense / Waterpump Pliers Special 250 mm	1	
2400	Üniversal Fort Pense PVC / Universal Grip 240 mm	1	

1

Vagon Serisi Takım Dolabı
Wagon Series Workshop Trolley

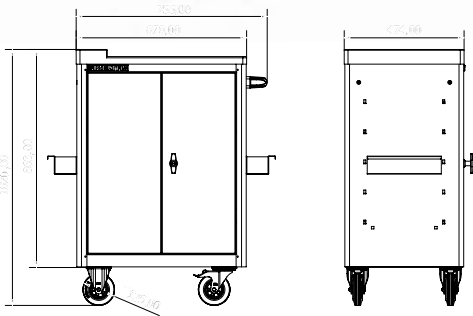

- ✓ 8 Bölmeli, sağlam ABS tabla
- Durable ABS worktop with divisions

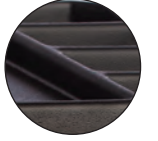

- ✓ Kilit T kol
- Locked T-handle

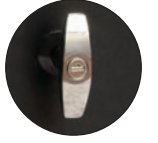

- ✓ 2 Sabit, 2 hareketli frenli tekerlek ø 125mm
- 2 swivel castors with brake 2 fixed castors ø 125 mm



- ✓ Yüksek dayanımlı elektrostatik toz boya.
- High strength electrostatic powder coating



- ✓ 2X ayarlanabilir raf (10 adet seperatör ile)
- 2x adaptable shelves with separator 10 pcs



- ✓ Standard tutma sapı
- Standard handle



- ✓ 2X avadanlık
- 2X tin holder



RAL 7016
RAL 3020

Ölçü/Size: 474x670x1020 mm

Sacdan imal edilmiş, Fırın boya
Made of sheet metal, Electrostatic paint

KOD/CODE	Ölçü / SIZE (mm)	KG	RENK COLORS	FİYAT TL/AD
----------	------------------	----	-------------	-------------

8210 32 6001

470x670x1020

45

RAL 7016
RAL 3020

1425,30

8160 TAKIM DOLABI / TOOL CABINET

Takım Dolabı
Tool Cabinet

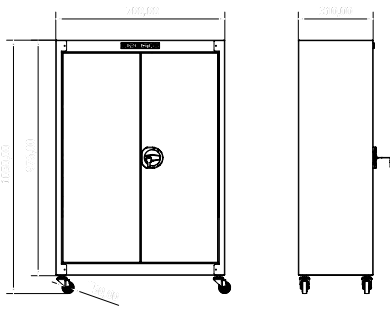

Ölçü/Size: 310x700x1050 mm

Sacdan imal edilmiş, Fırın boyalı
Made of sheet metal, Electrostatic paint

✓ Kilit T kol
● Locked T-handle

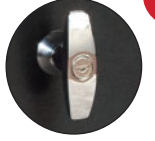

✓ %100 açılabilir teleskobik raylar.
● %100 extendable telescopic slides



✓ 2 hareketli frenli tekerlek ø 50mm
● 2 swivel castors with brake ø 50 mm



✓ Yüksek dayanımlı elektrostatik toz boya.
● High strength electrostatic powder coating

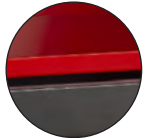

✓ Avadanlık x2
● Bottle and tins holder x2



✓ Askılık x4
● Hanger x4



✓ Özel askılık x4
● Special hanger x4



✓ Anahtar askısı x1
● Hanger for wrenches x1

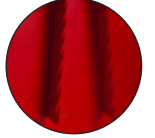

✓ Özel avadanlık x1
● Special tin holder x1

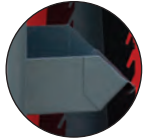

✓ Matkap ucu tutucu x1
● Drill bits holder x1



RAL 7016
RAL 3020



KOD/CODE	 20 kg	Ölçü / SIZE (mm)	 KG	COLORS	FİYAT TL/Ad.
----------	---	------------------	--	--------	--------------

8160 32 6001

3x

250x650x1010

35

RAL 7016
RAL 3020

1256,50

Demonte Mini Servis Arabası Disassembled Mini Service Trolley

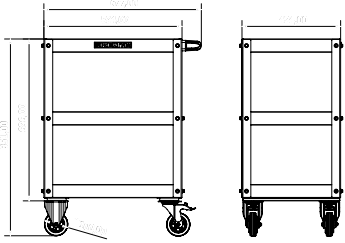

Çelik konstrüksiyon
Steel construction

- **3X Kauçuk Kaydırmaz Mat**
3X Rubber Anti Slipping Mats
- **2X Sabit, 2X Hareketli Frenli Tekerlek (ø 100 mm)**
2X Fixed, 2X Swivel Castors with Brake (ø 100 mm)
- **Sağlam sac metal yapı, Her raf 50 Kg taşır.**
Robust sheet-steel construction, Loading capacity per shelf 50 Kg

KOD/CODE	 420x590x57	Ölçü / SIZE (mm)	 KG	COLORS	FİYAT TL/Ad.
----------	---	------------------	---	--------	-----------------

8550 34 8001

3x

424x594x851

18

RAL 9005
RAL 3020

670,00

Demonte Mini Servis Arabası (kapalı) Disassembled Mini Service Trolley (closed)

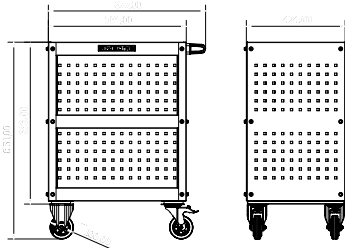

Çelik konstrüksiyon
Steel construction

- **3X Kauçuk Kaydırmaz Mat**
3X Rubber Anti Slipping Mats
- **2X Sabit, 2X Hareketli Frenli Tekerlek (ø 100 mm)**
2X Fixed, 2X Swivel Castors with Brake (ø 100 mm)
- **Sağlam sac metal yapı, Her raf 50 Kg taşır.**
Robust sheet-steel construction, Loading capacity per shelf 50 Kg
- **Arabanın yanları ve arkasında kare askı delikleri**
Square-shaped perforation on the side panels and back panel offers individual fastening

KOD/CODE	 420x590x57	Ölçü / SIZE (mm)	 KG	COLORS	FİYAT TL/Ad.
----------	---	------------------	---	--------	-----------------

8550 34 8002

3x

424x594x851

23

RAL 9005
RAL 3020

850,00

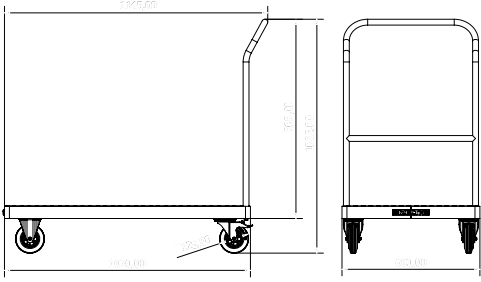
8545
1
Taşıma Arabası
Platform Wagon

- **18mm Plywood Tabla (Kauçuk Mat ile Birlikte)**
18mm PLYWOOD table (with rubber mat)
- **2X Sabit, 2X Hareketli Frenli Tekerlek (ø 200mm)**
2X Fixed, 2X Swivel Castors with Brake (ø 200mm)
- **Sağlam sac metal yapı, Her raf 540 Kg taşır.**
Robust sheet-steel construction, Loading capacity per shelf 540 Kg

 Çelik konstrüksiyon
 Steel construction

KOD/CODE	Ölçü / SIZE (mm)	KG	COLORS	FİYAT TL/Ad.
----------	------------------	----	--------	--------------

8545 34 1005

600x1145x1025

38

RAL 9005

1624,05

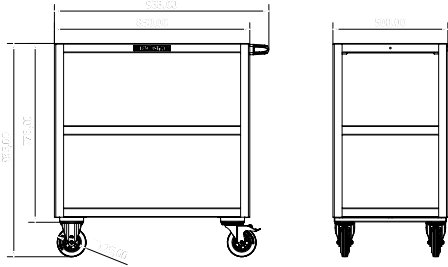
8550
Servis Arabası (Büyük Boy)
Service Trolley (Large Size)

- **3X Kauçuk Kaydırmaz Mat**
3X Rubber Anti Slipping Mats
- **2X Sabit, 2X Hareketli Frenli Tekerlek (ø 125 mm)**
2X Fixed, 2X Swivel Castors with Brake (ø 125 mm)
- **Sağlam sac metal yapı, Her raf 75 Kg taşır.**
Robust sheet-steel construction, Loading capacity per shelf 75 Kg

 Çelik konstrüksiyon
 Steel construction

KOD/CODE	75 kg	Ölçü / SIZE (mm)	KG	COLORS	FİYAT TL/Ad.
----------	-------	------------------	----	--------	--------------



494x844x40

8550 34 6001

3x

500x850x935

37

RAL 3020

1152,05

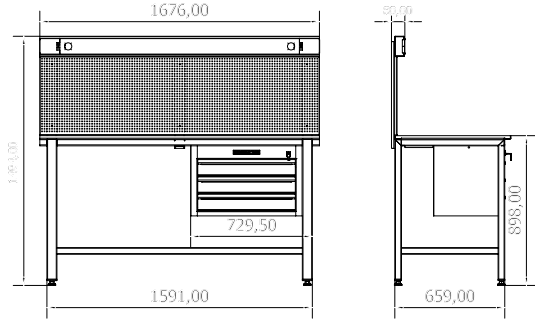
Servis Masası (Panolu)
Work Bench (With Panel)

- **Merkezi kilit sistemi, mandal sistemi**
Central locking system, handgrip lock system
- **Kaynaklı sağlam tasarım**
Robust welded design
- **%100 Açılabilir teleskobik raylar**
100% extendable telescopic slides
- **Yüksek dayanımlı elektrostatik toz boya.**
High strength electrostatic powder paint
- **Delikli panel (220 V prizler ile).**
Perforated panel with electrical plugs 220 V

Çelik Konstrüksiyon ve zor koşullarda çalışmaya elverişli
 Özel Plywood ahşap tezgah
 Strong and durable steel construction and Plywood bench

KOD/CODE		Ölçü / SIZE (mm)	KG	COLORS	FIYAT TL/Ad.
----------	--	------------------	----	--------	--------------

8500 34 6001

3x

720x1680x1495

102

 RAL 7016
 RAL 3020

3500,00

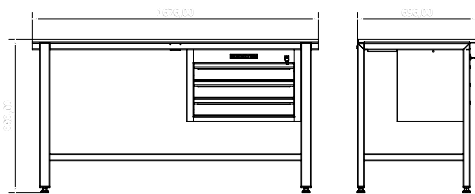
8501
Servis Masası (Panosuz)
Work Bench (Without Panel)

- **Merkezi kilit sistemi, mandal sistemi**
Central locking system, handgrip lock system
- **Kaynaklı sağlam tasarım**
Robust welded design
- **%100 Açılabilir teleskobik raylar**
100% extendable telescopic slides
- **Yüksek dayanımlı elektrostatik toz boya.**
High strength electrostatic powder paint

Çelik konstrüksiyon ve zor koşullarda çalışmaya elverişli
 Özel Plywood ahşap tezgah
 Strong and durable steel construction and Plywood bench

KOD/CODE		Ölçü / SIZE (mm)	KG	COLORS	FIYAT TL/Ad.
----------	--	------------------	----	--------	--------------

8501 34 6001

3x

700x1680x900

84

 RAL 7016
 RAL 3020

2650,00

Demonte Servis Masası
Disassembled Work Bench

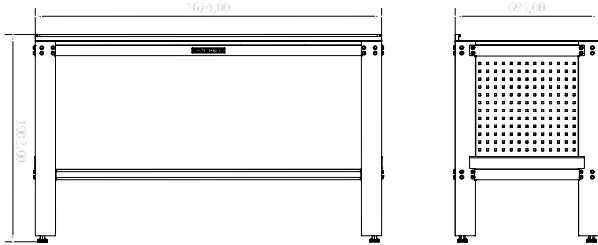

- **Demonte sağlam tasarım**
Robust disassembled design
- **18mm Plywood Tabla (Kauçuk mat ile birlikte)**
18mm Plywood Bench with non-slip rubber insert
- **Ayarlanabilir ayaklar**
Height adjustable feet
- **İZELTAS Eco ve/veya Trend Dolaplar ile kombine kullanabilme imkanı**
Can be combined with IZELTAS Eco and Trend Trolley

Çelik konstrüksiyon
Steel construction

KOD/CODE		Ölçü / SIZE (mm)	 KG	COLORS	FİYAT TL/Ad.
	200x500x55				

8502 34 6001

3x

694x1674x1002



35

RAL 3020

2300,00

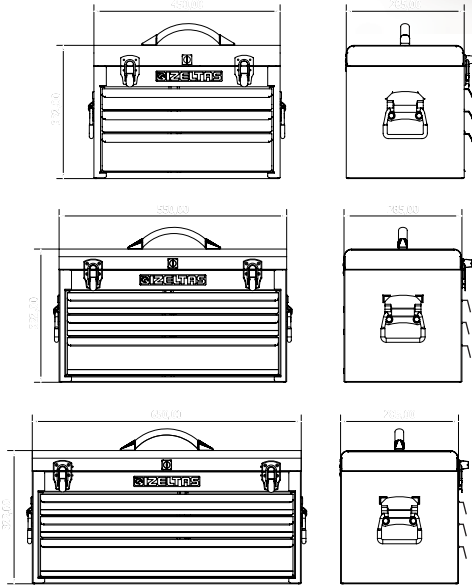
Çekmeceli Alet Sandığı
Tool Chest With Drawers

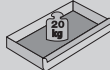
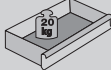

KOD/CODE	Ölçü / SIZE (mm)	ÇEKMECE DRAWERS				FİYAT TL/Ad
8320 33 1001	285x450x322	3x	2x	1x	16	1162,35
★8320 33 1002	285x550x322	3x	2x	1x	18	1174,70
8320 33 1003	285x650x322	3x	2x	1x	20	1187,05

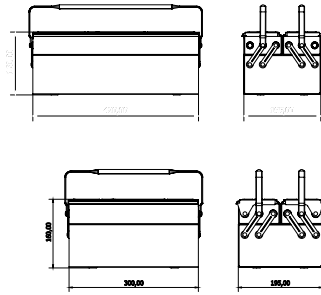
8420
Takım Çantası (3 Gözlü)
Tool Box (3 Trays)

Sacdan imal edilmiş, Fırın boya
 Made from metal sheet, Electrostatic paint

KOD CODE	Ölçü / SIZE (mm)	g	TL/Ad	FİYAT TL/Ad
8410 33 6103	190x300x150	2400	1	117,75
8410 33 6203	190x420x150	3000	1	147,20

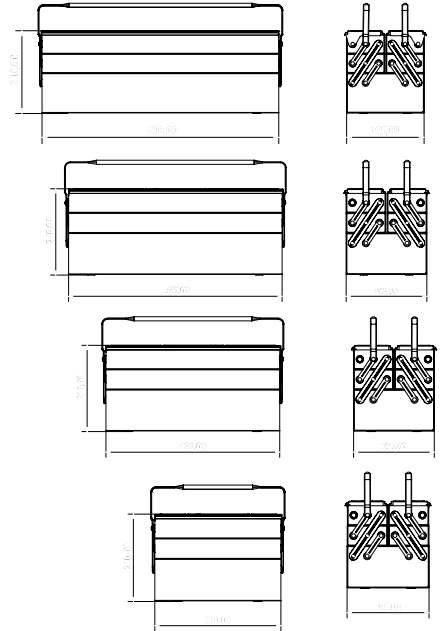
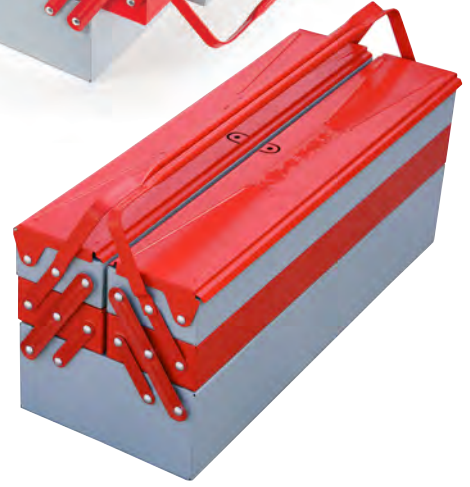
8420
Takım Çantası (5 Gözlü)
Tool Box (5 Trays)

Sacdan imal edilmiş, Fırın boya
 Made from metal sheet, Electrostatic paint

KOD CODE	Ölçü / SIZE (mm)	g	TL/Ad	FİYAT TL/Ad
8420 33 6105	195x300x210	3200	1	172,50
8420 33 6205	195x420x210	4200	1	179,10
8420 33 6305	195x520x210	5000	1	204,10
8420 33 6405	195x600x210	5600	1	275,00

(★) İşaretli olan ürünler stoklarla sınırlıdır.
 Limited with stocks.

1 Takım Çantası (5 Gözlü)
Tool Box (5 Trays)**8420 00 5063**

Mekanikçi Takım Çantası (62 Parça, 5 Gözlü)
Tool Box for Mechanician (62 Pcs, 5 Trays)

**8420 00 5046**

Elektrikçi Takım Çantası (45 Parça, 5 Gözlü)
Tool Box for Electrician (45 Pcs, 5 Trays)

**8420 00 5028**

Tesisatçı Takım Çantası (28 Parça, 5 Gözlü)
Tool Box for Plumbers (28 Pcs, 5 Trays)



8420 00 5063
Mekanikçi Takım Çantası (5 Gözlü)
Tool Box for Mechanician (5 Trays)

KOD CODE	ÖLÇÜ SIZE mm	TL/Ad.
8420 00 5063	195x420x210 DOLU / FULL	62 1540,10

KOD CODE	İÇERİK CONTENTS	
05881 50 015	5 m Krom Şerit Metre Chrom Case Steel, Measuring tapes	1
4785 19 6330	6.3x30 Kısa Bits Tutucu Tornavida Screwdriver, Magnetic Bit Holder (Short)	1
4800 00 8110	10 'Lu Bits Takım Bits Set 10 (Pcs) 25 mm	10
4320	Yıldız Uçlu Tornavida Opak Seri Screwdriver, Opak, Flat 4.5x80-6x100	2
4300	Düz Uçlu Tornavida Opak Seri Screwdriver, Opak, Philips 3x80-4x100-5x125-6x150	4
4550 17 0135	135mm Kontrol Kalem Voltage Tester	1
2400 11 0240	240mm Üniversal Fort Pense Water Pump Pliers Universal	1
1113	1/2" Lokma Anahtar Socket Wrench 10-11-12-13-14-15-17-19-22-24-27-30-32 mm	13
1513 06 4250	1/2" Uzun Ara Kol Extension Bar Long 250 mm	1
1513 06 4070	1/2" Mafsal Universal Joint 70 mm	1
1513 06 0032	1/2" Cırcır Kol 32 Dişli Ratchet Handle 250 mm	1
4900 00 3112	12 'Li Allen Takım Hex Key Wrench Set	12
0320	Kısa Kombine Anahtar Combination Wrench Short Pattern 8-9-10-11-12-13-14-17-19-22 mm	10
3700 16 2160	160mm Opak İzole Yan Keski Side Cutting Nippers, Opak insulated	1
3020 12 2180	180mm Opak İzole Kombine Pense Combination Pliers, Opak Insulated	1
3220 13 2160	160mm Opak İzole Düz Kargaburun Nose Pliers, Flat, Opak Insulated	1

8420 00 5046
Elektrikçi Takım Çantası (5 Gözlü)
Tool Box for Electrician (5 Trays)

KOD CODE	ÖLÇÜ SIZE mm	TL/Ad.
8420 00 5046	195x420x210 DOLU / FULL	45 1662,05

KOD CODE	İÇERİK CONTENTS	
05881 50 005	5m Plastik Şerit Metre Plastic Measuring Tape	1
4783 19 6120	1000V İzoleli Manyetik Bits Tutucu Tornavida Screwdriver, Magnetic Bit Holder Insulated 6.3x120	1
4800 00 8106	6 'Li Bits Takım Bits Set (6 Pcs)	6
0600 01 1010	10" Kurbağcık Anahtar Adjustable Jaw Wrench, PVC Insulated	1
4140-4145	1000V İzoleli Elektrikçi Düz Yıldız Tornavida Insulated Electrician type Flat Screwdriver, Phillis 1000V 4x100-5.5x125 - 4.5x80-6x100	4
4550 17 0135	135mm Kontrol Kalem Voltage Tester	1
4550 17 0190	190mm Kontrol Kalem Voltage Tester	1
4773	1000V Süngüsü İzoleli Lokma Uçlu Tornavida Nut Spinner, Electrician Blade Insulated 1000V 6-7-8-10-13 mm	5
0340	Cırcır Kombine Anahtar Combination Wrench With Ratchet 8-10-12-13-17-19 mm	6
4900 00 3110	10 'Lu Allen Anahtar Takımı (mm) Hex Key Wrench Set 10 pcs	10
4500-4520	Klemens Tornavida Screwdriver, Electronic 3x80-3x100-3x125-3x60-4x80	5
3700 16 6160	1000V İzoleli Elektrikçi 160mm Yan Keski Insulated Electrician Type Side Cutter 1000V	1
3020 12 6180	1000V İzoleli Elektrikçi 180mm Kombine Pense Insulated Electrician Type Combination Plier 1000V	1
3220 13 6160	1000V İzoleli Elektrikçi 160mm Kargaburun Insulated Electrician Type Nose Plier 1000V	1

8420 00 5028
Tesisatçı Takım Çantası (5 Gözlü)
Tool Box for Plumbers (5 Trays)

KOD CODE	ÖLÇÜ SIZE mm	TL/Ad.
8420 00 5028	195x420x210 DOLU / FULL	28 1605,85

KOD CODE	İÇERİK CONTENTS	
0600 01 1010	10" Kurbağcık Anahtar 10" Adjustable Jaw Wrench, PVC Insulated	1
0600 01 1012	12" Kurbağcık Anahtar 12" Adjustable Jaw Wrench, PVC Insulated	1
2400 11 0240	240 Üniversal Fort Pense 240 Waterpump Pliers, Universal	1
2100 10 0012	12" Stilson Boru Anahtarı 12" Pipe Wrench, Stillson	1
4901 22 1270	1/2" Sae Allen Anahtar 1/2" Hex Key Wrench SAE	1
4300 17 6150	Düz Uçlu Tornavida Opak Seri Screwdriver, Opak, Slotted 6x150 mm	1
4320 18 6100	Yıldız Uçlu Tornavida Opak Seri Screwdriver, Opak, Phillips 6x100 mm	1
5800 25 0500	500gr Çekiç / Machinist Hammer	1
5500 23 0200	200mm Düz Keski / Flat Cold Chisel	1
3830 15 0250	250mm Betoncu Kerpeten Tower Pincers	1
4900 00 3112	12 'Li Allen Anahtar Takımı (mm) Hex Key Wrench Set 12 pcs	12
0588 15 0015	5m Krom Şerit Metre Chrom Case Steel Measuring Tape	1
2201 10 0010	1" Maşalı Boru Anahtarı 1" Pipe Wrench	1
3700 16 2160	160mm Opak İzole Yan Keski Side Cutting Nippers, Opak insulated	1
3020 12 2180	180mm Opak İzole Kombine Pense Combination Pliers, Opak Insulated	1
3220 13 2160	160mm Opak İzole Düz Kargaburun Nose Pliers, Flat, Opak Insulated	1

1

8440

1

Plastik Takım Çantaları
Plastic Tool Boxes



KOD CODE	inch	ÖLÇÜ SIZE mm	g	TL/ Ad.
8440 33 1016	16"	413x212x186	1207	4 60,00
8440 33 1019	19"	480x267x242	1922	4 75,00
8440 33 1022	22"	564x310x310	2870	4 125,00

8445

Tekerlekli Plastik Takım Çantası
Plastic Mobile Tool Chest



KOD CODE	inch	ÖLÇÜ SIZE mm	g	TL/ Ad.
8445 33 1028	28"	380x595x420	5900	1 295,00

8705 00 6113

Hobby Set Oto Tipi (13 Parça)
Hobby Set Auto Type (13 pcs)



KOD CODE	İÇERİK CONTENTS	TL/ Ad.
0100	İki Ağız Anahtar (Kısa Boy) Duble Ended Open Jaw Wrench Short Pattern 8x9-10x11-12x13-14x15-16x17-18x19	6
1841	21 mm Kovan Anahtar Bir Ağız Single Ended Tubular Socket Wench	1
2400	240 mm Ünlversal Fort Pense Waterpump Pliers Universal	1
3020	160 mm Kombine Pense Opak Combination Pliers	1
4240	Değişken Uçlu Tornavida Takımı Screwdriver Set Reversible 4.5x80 - 6x80	1
5800	200 gr Tesviyeci Çekiç / Machinist Hammer	1
6350	300 mm Levye Oluklu / Tyre Lever Straight	1

8790 00 8106

Bakım Onarım Seti (5 Parça)
Maintenance Set (5 Pcs)



KOD CODE	İÇERİK CONTENTS	TL/ Ad.
3020 12 3160	160 mm Kombine Pense Kraft Combination Pliers	1
3220 13 3160	160 mm Kargaburun Düz Uçlu Kraft Nose Pliers Flat	1
3700 16 3140	140 mm Yan Keski Kraft Side Cutting Pliers	1
4100 17 5100	5x100 Kraft Seri Düz Uçlu Tornavida Screwdriver Kraft, Flat	1
4120 18 4580	4.5x80 Kraft Seri Yıldız Uçlu Tornavida Screwdriver Kraft, Phillips	1

(★) İşaretili olan ürünler stoklarla sınırlıdır.
Limited with stocks.

8786 00 1003

Doğada Set (3 Parça)
Outdoor Set (3 Pcs)

**YENİ
NEW**

8793 00 1014

Bakım Seti (14 Parça)
Maintenance Set (14 Pcs)

**YENİ
NEW**



1

KOD CODE	İÇERİK CONTENTS	☐	TL/ Ad.
6710 27 0230	Bağ Makası Lüks / Pruning Shears	1	
6735 27 0300	Dal Budama Testeresi / Pruning Saw	1	428,10
6410 25 0800	Nacak / Hatchet	1	

KOD CODE	İÇERİK CONTENTS	☐	TL/Ad.
0130	İki Ağız Anahtar (Uzun Boy) Double Ended Open Jaw Wrench Long Pattern 6x7-8x9-10x11-12x13-14x15-16x17-18x19-20x22	8	
3220	160 mm Kargaburun Düz Uçlu Ergonomik Long Nose Pliers Flat	1	
3700	140 mm Yan Keski Ergonomik Side Cutting Pliers	1	410,20
4350	Ergonomik Seri Düz Uçlu Tornavida 4x100-6x100 Screwdriver Ergonomic, Flat	2	
4370	Ergonomik Seri Yıldız Uçlu Tornavida 4.5x80-6x100 Screwdriver Ergonomic, Phillips	2	

