

# MILLING / holders

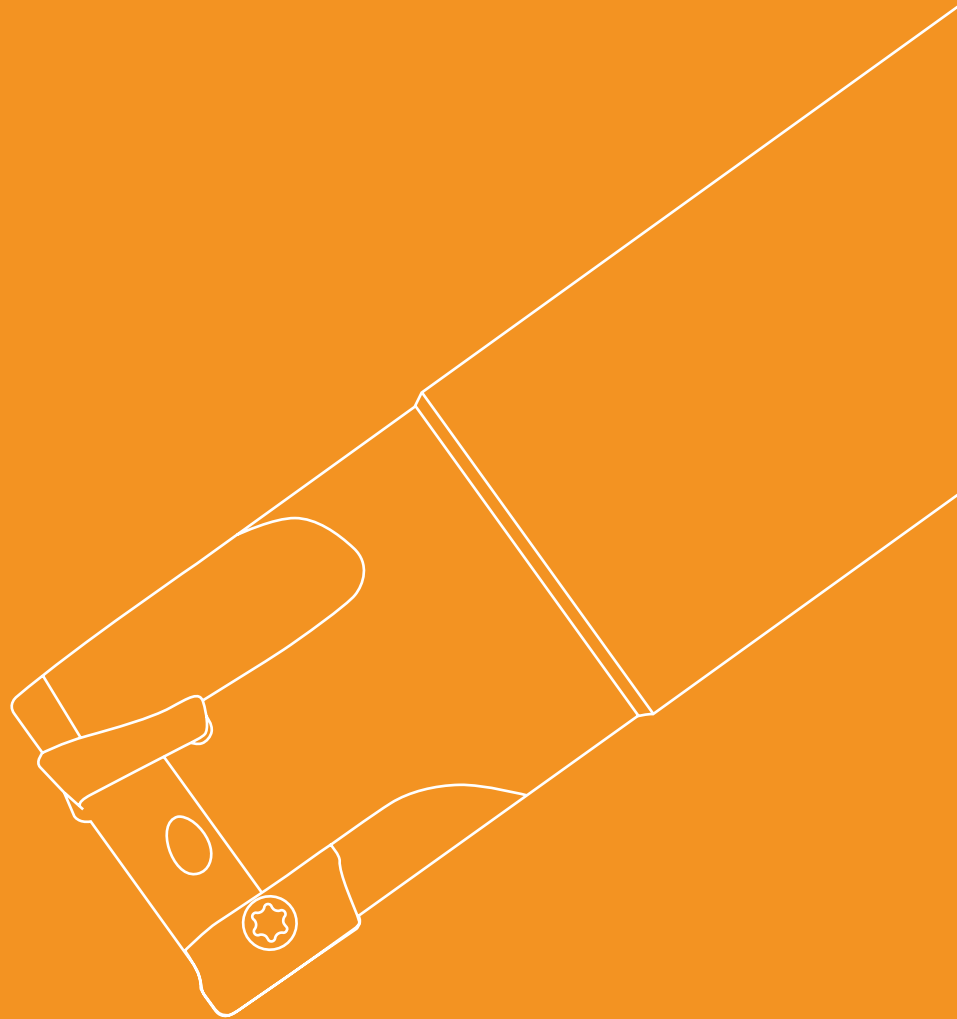

TURNING

GROOVING

THREADING

MILLING

DRILLING

ENDMILLS

DRILLS

SPARE PARTS

INDEX

# MSAP

## AP□□10

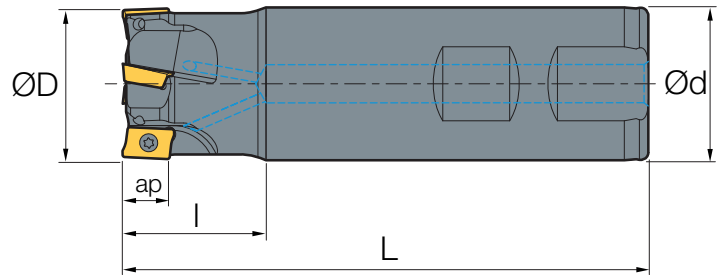

AP□□	DESCRIPTION	STOCK	DIMENSIONS										
			D	L	l	d	Z	ap					
AP□□10	MSAP 12-120-10-12-1T	●	12	120	30	12	1T	10	ST-SC0256	ST-WRT08			
	12-120-10-16-1T	●	12	120	30	16	1T	10	ST-SC0256	ST-WRT08			
	14-120-10-16-1T	●	14	120	30	16	1T	10	ST-SC0256	ST-WRT08			
	16-120-10-16-2T	●	16	120	30	16	2T	10	ST-SC0256	ST-WRT08			
	16-120-10-16-2T-C	●	16	120	30	16	2T	10	ST-SC0256	ST-WRT08			
	16-150-10-16-2T	●	16	150	40	16	2T	10	ST-SC0256	ST-WRT08			
	16-150-10-16-2T-C	●	16	150	40	16	2T	10	ST-SC0256	ST-WRT08			
	16-200-10-16-2T	●	16	200	50	16	2T	10	ST-SC0256	ST-WRT08			
	18-120-10-16-2T	●	18	120	30	16	2T	10	ST-SC0256	ST-WRT08			
	18-150-10-16-2T	●	18	150	40	16	2T	10	ST-SC0256	ST-WRT08			
	18-200-10-16-2T	●	18	200	50	16	2T	10	ST-SC0256	ST-WRT08			
	20-120-10-20-3T	●	20	120	30	20	3T	10	ST-SC0256	ST-WRT08			
	20-120-10-20-3T-C	●	20	120	30	20	3T	10	ST-SC0256	ST-WRT08			
	20-150-10-20-3T	●	20	150	40	20	3T	10	ST-SC0256	ST-WRT08			
	20-200-10-20-3T	●	20	200	50	20	3T	10	ST-SC0256	ST-WRT08			
	22-120-10-20-3T	●	22	120	30	20	3T	10	ST-SC0256	ST-WRT08			
	22-150-10-20-3T	●	22	150	40	20	3T	10	ST-SC0256	ST-WRT08			
	22-200-10-20-3T	●	22	200	50	20	3T	10	ST-SC0256	ST-WRT08			
	23-120-10-20-3T	●	23	120	30	20	3T	10	ST-SC0256	ST-WRT08			
	24-120-10-20-3T	●	24	120	30	20	3T	10	ST-SC0256	ST-WRT08			
24-150-10-20-3T	●	24	150	40	20	3T	10	ST-SC0256	ST-WRT08				

carbide

304

# MSAP

## AP□□10

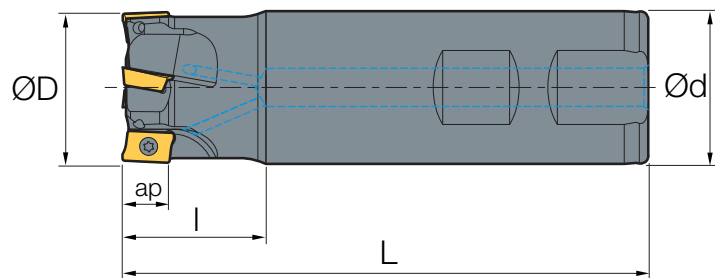

AP□□	DESCRIPTION	STOCK	DIMENSIONS											
			D	L	l	d	Z	ap						
AP□□10	MSAP	24-200-10-20-3T	●	24	200	50	20	3T	10	ST-SC0256	ST-WRT08			
		25-120-10-25-3T	●	25	120	30	25	3T	10	ST-SC0256	ST-WRT08			
		25-120-10-25-3T-C	●	25	120	30	25	3T	10	ST-SC0256	ST-WRT08			
		25-150-10-25-3T	●	25	150	40	25	3T	10	ST-SC0256	ST-WRT08			
		25-200-10-25-3T	●	25	200	50	25	3T	10	ST-SC0256	ST-WRT08			
		25-250-10-25-3T	●	25	250	50	25	3T	10	ST-SC0256	ST-WRT08			
		26-120-10-25-3T	●	26	120	30	25	3T	10	ST-SC0256	ST-WRT08			
		26-120-10-25-3T-C	●	26	120	30	25	3T	10	ST-SC0256	ST-WRT08			
		26-150-10-25-3T	●	26	150	40	25	3T	10	ST-SC0256	ST-WRT08			
		26-200-10-25-3T	●	26	200	50	25	3T	10	ST-SC0256	ST-WRT08			
		30-120-10-25-4T	●	30	120	30	25	4T	10	ST-SC0256	ST-WRT08			
		30-150-10-25-4T	●	30	150	40	25	4T	10	ST-SC0256	ST-WRT08			
		32-120-10-25-4T	●	32	120	30	25	4T	10	ST-SC0256	ST-WRT08			
		32-120-10-32-4T	●	32	120	30	32	4T	10	ST-SC0256	ST-WRT08			
		32-120-10-32-4T-C	●	32	120	30	32	4T	10	ST-SC0256	ST-WRT08			
		32-150-10-25-4T	●	32	150	40	25	4T	10	ST-SC0256	ST-WRT08			
		32-150-10-32-4T	●	32	150	40	32	4T	10	ST-SC0256	ST-WRT08			
		32-300-10-32-4T	●	32	300	50	32	4T	10	ST-SC0256	ST-WRT08			
		35-120-10-32-5T	●	35	120	30	32	5T	10	ST-SC0256	ST-WRT08			
		40-120-10-32-5T	●	40	120	30	32	5T	10	ST-SC0256	ST-WRT08			
	40-150-10-32-5T	●	40	150	40	32	5T	10	ST-SC0256	ST-WRT08				

TURNING

GROOVING

THREADING

MILLING

DRILLING

ENDMILLS

DRILLS

SPARE PARTS

INDEX

carbide

304

TURNING

GROOVING

THREADING

MILLING

DRILLING

ENDMILLS

DRILLS



SPARE PARTS

INDEX

# MMAP

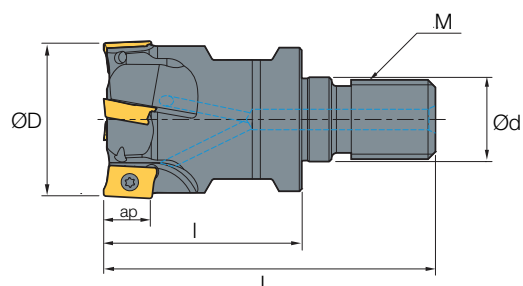
## AP□□10



AP□□	DESCRIPTION	STOCK	DIMENSIONS							ap	  			
			D	L	I	d	Z	M						
AP□□10	MMAP 16-M08-10-2T-C	●	16	50	28	8.5	2T	08	10	ST-SC0257	ST-WRT08			
	20-M10-10-3T-C	●	20	50	28	10.5	3T	10	10	ST-SC0257	ST-WRT08			
	25-M12-10-3T-C	●	25	50	28	12.5	3T	12	10	ST-SC0257	ST-WRT08			
	32-M16-10-4T-C	●	32	60	35	17	4T	16	10	ST-SC0257	ST-WRT08			
	35-M16-10-4T	●	35	60	35	17	4T	16	10	ST-SC0257	ST-WRT08			
	40-M16-10-5T-C	●	40	60	35	17	5T	16	10	ST-SC0257	ST-WRT08			
	42-M16-10-5T-C	●	42	60	35	17	5T	16	10	ST-SC0257	ST-WRT08			

carbide ▶ 304

# MFAP

## AP□□10

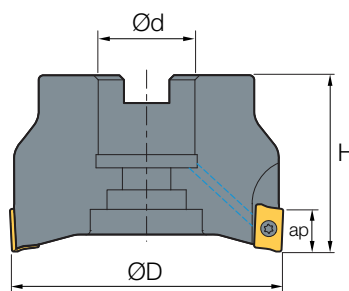

AP□□	DESCRIPTION	STOCK	DIMENSIONS								
			D	H	d	Z	ap				
AP□□10	MFAP 90040R-10-5T	●	40	40	16	5T	10	ST-SC0257	ST-WRT08		
	90040R-10-5T-C	●	40	40	16	5T	10	ST-SC0257	ST-WRT08		
	90050R-10-6T	●	50	40	22	6T	10	ST-SC0257	ST-WRT08		
	90050R-10-6T-C	●	50	40	22	6T	10	ST-SC0257	ST-WRT08		
	90063R-10-7T	●	63	40	22	7T	10	ST-SC0257	ST-WRT08		
	90063R-10-7T-C	●	63	40	22	7T	10	ST-SC0257	ST-WRT08		
	90080R-10-8T	●	80	50	27	8T	10	ST-SC0257	ST-WRT08		
	90080R-10-8T-C	●	80	50	27	8T	10	ST-SC0257	ST-WRT08		
	90100R-10-9T	●	100	50	32	9T	10	ST-SC0257	ST-WRT08		
	90100R-10-9T-C	●	100	50	32	9T	10	ST-SC0257	ST-WRT08		
	90125R-10-11T	●	125	50	40	11T	10	ST-SC0257	ST-WRT08		

carbide 304

- TURNING
- GROOVING
- THREADING
- MILLING
- DRILLING
- ENDMILLS
- DRILLS
- SPARE PARTS
- INDEX

TURNING

GROOVING

THREADING

MILLING

DRILLING

ENDMILLS

DRILLS

SPARE PARTS

INDEX

### MFAP

### AP□□10

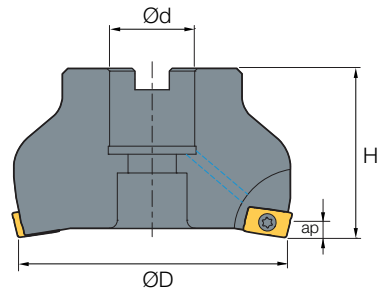

AP□□	DESCRIPTION		STOCK	DIMENSIONS							
				D	H	d	Z	ap			
AP□□10	MFAP	75063R-10-5T	●	63	40	22	5T	5	ST-SC0257	ST-WRT08	
		75063R-10-5T-C	●	63	40	22	5T	5	ST-SC0257	ST-WRT08	
		75080R-10-6T	●	80	40	27	6T	5	ST-SC0257	ST-WRT08	
		75080R-10-6T-C	●	80	40	27	6T	5	ST-SC0257	ST-WRT08	
		75100R-10-7T	●	100	50	32	7T	5	ST-SC0257	ST-WRT08	
		75100R-10-7T-C	●	100	50	32	7T	5	ST-SC0257	ST-WRT08	

### MFAP

### AP□□12

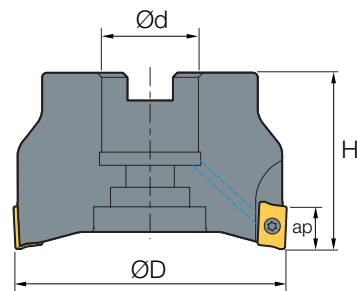

AP□□	DESCRIPTION		STOCK	DIMENSIONS							
				D	H	d	Z	ap			
AP□□12	MFAP	90050R-12-6T	●	50	40	22	6T	12	ST-SC0257	ST-WRT08	
		90063R-12-7T	●	63	40	22	7T	12	ST-SC0257	ST-WRT08	
		90080R-12-8T	●	80	50	27	8T	12	ST-SC0257	ST-WRT08	

carbide

304

# MSAP

# AP□□11

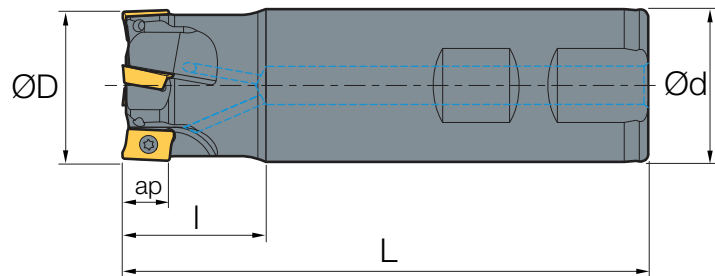

AP□□	DESCRIPTION	STOCK	DIMENSIONS											
			D	L	l	d	Z	ap						
AP□□11	MSAP	16-160-11-15-2T-C	●	16	160	40	15	2T	11	ST-SC0256	ST-WRT08			
		16-160-11-16-2T-C	●	16	160	40	16	2T	11	ST-SC0256	ST-WRT08			
		16-200-11-16-2T-C	●	16	200	50	16	2T	11	ST-SC0256	ST-WRT08			
		17-160-11-16-2T-C	●	17	160	40	16	2T	11	ST-SC0256	ST-WRT08			
		17-200-11-16-2T-C	●	17	200	50	16	2T	11	ST-SC0256	ST-WRT08			
		20-160-11-20-3T-C	●	20	160	40	20	3T	11	ST-SC0256	ST-WRT08			
		20-200-11-20-3T-C	●	20	200	50	20	3T	11	ST-SC0256	ST-WRT08			
		21-160-11-20-3T-C	●	21	160	40	20	3T	11	ST-SC0256	ST-WRT08			
		21-200-11-20-3T-C	●	21	200	50	20	3T	11	ST-SC0256	ST-WRT08			
		25-160-11-25-3T-C	●	25	160	40	25	3T	11	ST-SC0256	ST-WRT08			
		25-200-11-25-3T-C	●	25	200	50	25	3T	11	ST-SC0256	ST-WRT08			
		26-160-11-25-3T-C	●	26	160	40	25	3T	11	ST-SC0256	ST-WRT08			
		26-200-11-25-3T-C	●	26	200	50	25	3T	11	ST-SC0256	ST-WRT08			
		32-160-11-32-4T-C	●	32	160	40	32	4T	11	ST-SC0256	ST-WRT08			
		33-160-11-32-4T-C	●	33	160	40	32	4T	11	ST-SC0256	ST-WRT08			
	33-200-11-32-4T-C	●	33	200	50	32	4T	11	ST-SC0256	ST-WRT08				

TURNING

GROOVING

THREADING

MILLING

DRILLING

ENDMILLS

DRILLS

SPARE PARTS

INDEX

carbide

304

# Holders

## MILLING

TURNING

GROOVING

THREADING

MILLING

DRILLING

ENDMILLS

DRILLS

SPARE PARTS

INDEX

MMAP

AP□□11

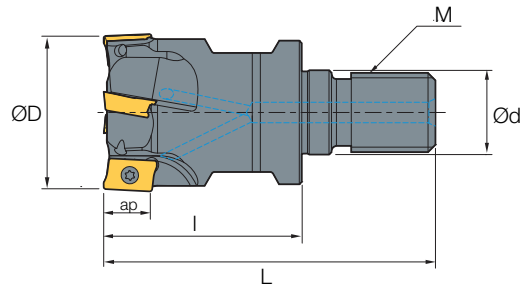

AP□□	DESCRIPTION		STOCK	DIMENSIONS										
				D	L	I	d	Z	M	ap				
AP□□11	MMAP	16-M08-11-2T-C	●	16	50	28	8.5	2T	08	11	ST-SC0257	ST-WRT08		
		20-M10-11-3T-C	●	20	50	28	10.5	3T	10	11	ST-SC0257	ST-WRT08		
		25-M12-11-3T-C	●	25	50	28	12.5	3T	12	11	ST-SC0257	ST-WRT08		

carbide **304**



# MSAP

## AP□□16

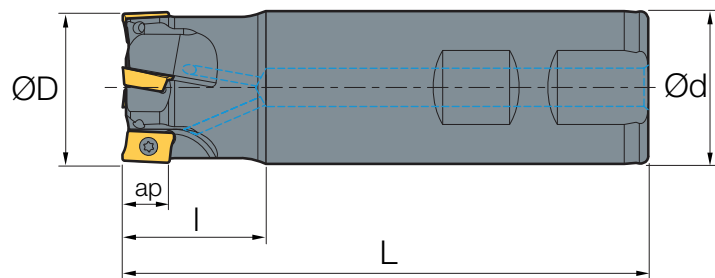

AP□□	DESCRIPTION	STOCK	DIMENSIONS											
			D	L	l	d	Z	ap						
AP□□16	MSAP	25-120-16-25-2T	●	25	120	30	25	2T	16	ST-SC0256	ST-WRT08			
		25-150-16-25-2T	●	25	150	40	25	2T	16	ST-SC0256	ST-WRT08			
		25-200-16-25-2T	●	25	200	50	25	2T	16	ST-SC0256	ST-WRT08			
		25-250-16-25-2T	●	25	250	70	25	2T	16	ST-SC0256	ST-WRT08			
		26-120-16-25-2T	●	26	120	30	25	2T	16	ST-SC0256	ST-WRT08			
		26-150-16-25-2T	●	26	150	40	25	2T	16	ST-SC0256	ST-WRT08			
		26-200-16-25-2T	●	26	200	50	25	2T	16	ST-SC0256	ST-WRT08			
		30-150-16-25-3T	●	30	150	40	25	3T	16	ST-SC0256	ST-WRT08			
		30-200-16-25-3T	●	30	200	50	25	3T	16	ST-SC0256	ST-WRT08			
		32-120-16-25-3T	●	32	120	30	25	3T	16	ST-SC0256	ST-WRT08			
		32-120-16-32-3T	●	32	120	30	32	3T	16	ST-SC0256	ST-WRT08			
		32-150-16-25-3T	●	32	150	50	25	3T	16	ST-SC0256	ST-WRT08			
		32-200-16-32-3T	●	32	200	50	32	3T	16	ST-SC0256	ST-WRT08			
		32-250-16-32-3T	●	32	250	70	32	3T	16	ST-SC0256	ST-WRT08			
		32-300-16-32-3T	●	32	300	70	32	3T	16	ST-SC0256	ST-WRT08			
		34-120-16-32-3T	●	34	120	30	32	3T	16	ST-SC0256	ST-WRT08			
		34-150-16-32-3T	●	34	150	50	32	3T	16	ST-SC0256	ST-WRT08			
		34-200-16-32-3T	●	34	200	50	32	3T	16	ST-SC0256	ST-WRT08			
		35-120-16-32-3T	●	35	120	30	32	3T	16	ST-SC0256	ST-WRT08			
		35-150-16-32-3T	●	35	150	50	32	3T	16	ST-SC0256	ST-WRT08			
		35-200-16-32-3T	●	35	200	50	32	3T	16	ST-SC0256	ST-WRT08			
		36-120-16-32-3T	●	36	120	30	32	3T	16	ST-SC0256	ST-WRT08			
		38-120-16-32-4T	●	38	120	30	32	4T	16	ST-SC0256	ST-WRT08			
		40-120-16-32-4T	●	40	120	30	32	4T	16	ST-SC0256	ST-WRT08			
	40-150-16-25-4T	●	40	150	50	25	4T	16	ST-SC0256	ST-WRT08				
	40-150-16-32-4T	●	40	150	50	32	4T	16	ST-SC0256	ST-WRT08				
	40-200-16-32-4T	●	40	200	50	32	4T	16	ST-SC0256	ST-WRT08				

carbide

304

TURNING

GROOVING

THREADING

MILLING

DRILLING

ENDMILLS

DRILLS

SPARE PARTS

INDEX

# MMAP

## AP□□16

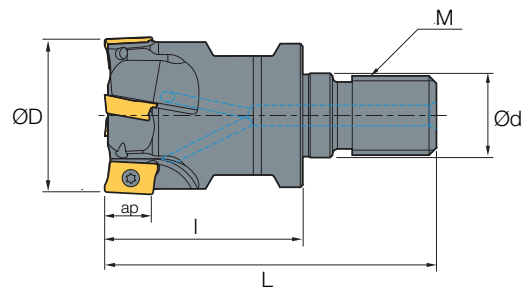

AP□□	DESCRIPTION	STOCK	DIMENSIONS											
			D	L	I	d	Z	ap	M					
AP□□16	MMAP 25-M12-16-2T-C	●	25	60	43	12	2T	16	12	ST-SC0257	ST-WRT08			
	32-M16-16-3T-C	●	32	60	43	16	3T	16	16	ST-SC0257	ST-WRT08			
	40-M16-16-4T-C	●	40	60	43	16	4T	16	16	ST-SC0257	ST-WRT08			
	42-M16-16-4T-C	●	42	60	43	16	4T	16	16	ST-SC0257	ST-WRT08			

# MFAP

## AP□□16

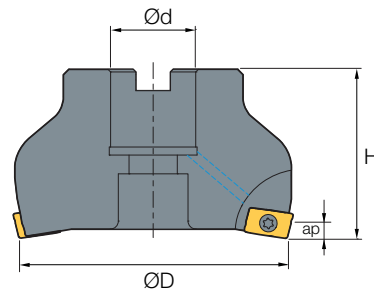

AP□□	DESCRIPTION	STOCK	DIMENSIONS								
			D	H	d	ap	Z				
AP□□16	MFAP 75063R-16-4T	●	63	40	22	16	4T	ST-SC0257	ST-WRT08		
	75063R-16-4T-C	●	63	40	22	16	4T	ST-SC0257	ST-WRT08		
	75080R-16-6T	●	80	40	27	16	6T	ST-SC0257	ST-WRT08		
	75080R-16-6T-C	●	80	40	27	16	6T				
	75100R-16-7T	●	100	50	32	16	7T				
	75100R-16-7T-C	●	100	50	32	16	7T				

carbide

304

# MFAP

## AP□□16

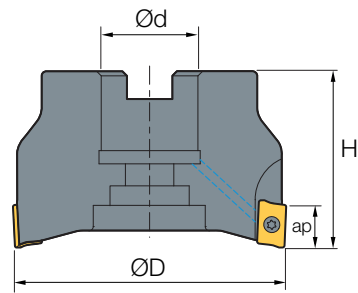

AP□□	DESCRIPTION	STOCK	DIMENSIONS							
			D	H	d	ap	Z			
AP□□16	MFAP 90040R-16-4T	●	40	40	16	16	4T	ST-SC0257	ST-WRT08	
	90040R-16-4T-C	●	40	40	22	16	4T	ST-SC0257	ST-WRT08	
	90050R-16-5T	●	50	40	22	16	5T	ST-SC0257	ST-WRT08	
	90050R-16-5T-C	●	50	40	22	16	5T	ST-SC0257	ST-WRT08	
	90063R-16-6T	●	63	40	22	16	6T	ST-SC0257	ST-WRT08	
	90063R-16-6T-C	●	63	40	22	16	6T	ST-SC0257	ST-WRT08	
	90080R-16-7T	●	80	50	22	16	7T	ST-SC0257	ST-WRT08	
	90080R-16-7T-C	●	80	50	22	16	7T	ST-SC0257	ST-WRT08	
	90100R-16-8T	●	100	50	32	16	8T	ST-SC0257	ST-WRT08	
	90100R-16-8T-C	●	100	50	32	16	8T	ST-SC0257	ST-WRT08	
	90125R-16-9T	●	125	63	40	16	9T	ST-SC0257	ST-WRT08	
	90160R-16-10T	●	160	63	40	16	10T	ST-SC0257	ST-WRT08	
90200R-16-12T	●	200	63	60	16	12T	ST-SC0257	ST-WRT08		

carbide 304

- TURNING
- GROOVING
- THREADING
- MILLING
- DRILLING
- ENDMILLS
- DRILLS
- SPARE PARTS
- INDEX

- TURNING
- GROOVING
- THREADING
- MILLING**
- DRILLING
- ENDMILLS
- DRILLS
- SPARE PARTS
- INDEX

# MFAP

## AP□□17

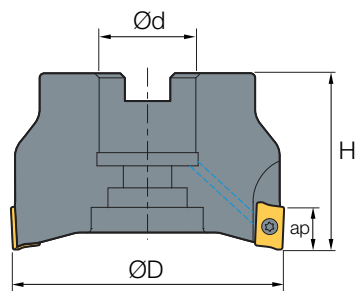

AP□□	DESCRIPTION	STOCK	DIMENSIONS									
			D	H	d	ap	Z					
AP□□17	MFAP	90050R-17-5T-C	●	50	40	22	16	5T	ST-SC0257	ST-WRT08		
		90063R-17-6T-C	●	63	40	22	16	6T	ST-SC0257	ST-WRT08		
		90080R-17-7T-C	●	80	50	22	16	7T	ST-SC0257	ST-WRT08		
		90100R-17-9T-C	●	100	50	32	16	8T	ST-SC0257	ST-WRT08		

carbide 304

# MSRD

## RD□□

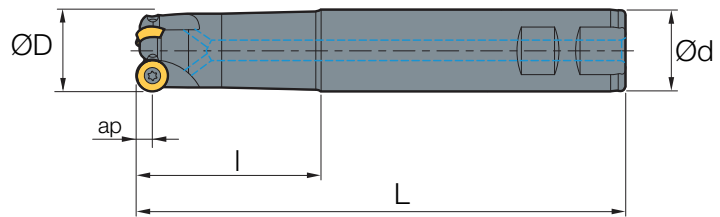

RD□□	DESCRIPTION	STOCK	DIMENSIONS										
			D	L	l	d	Z	ap					
RD□□08	MSRD 16-160-08-16-2T	●	16	160	55	25	2T	08	ST-SC0256	ST-WRT08			
	20-160-08-20-2T	●	20	160	55	25	2T	08	ST-SC0256	ST-WRT08			
	25-160-08-25-3T	●	25	160	55	25	3T	08	ST-SC0256	ST-WRT08			
RD□□10	MSRD 20-120-10-20-2T	●	20	120	55	20	2T	10	ST-SC3508	ST-WRT15			
	20-160-10-20-2T	●	20	160	55	20	2T	10	ST-SC3508	ST-WRT15			
	20-200-10-20-2T	●	20	200	55	20	2T	10	ST-SC3508	ST-WRT15			
	25-120-10-25-2T	●	25	120	55	25	2T	10	ST-SC3508	ST-WRT15			
	25-160-10-25-2T	●	25	160	55	25	2T	10	ST-SC3508	ST-WRT15			
	25-200-10-25-2T	●	25	200	55	25	2T	10	ST-SC3508	ST-WRT15			
	32-120-10-32-3T	●	32	120	55	32	3T	10	ST-SC3508	ST-WRT15			
	32-160-10-32-3T	●	32	160	55	32	3T	10	ST-SC3508	ST-WRT15			
	32-200-10-32-3T	●	32	200	55	32	3T	10	ST-SC3508	ST-WRT15			
	40-120-10-32-4T	●	40	120	55	32	4T	10	ST-SC3508	ST-WRT15			
	40-160-10-32-4T	●	40	160	55	32	4T	10	ST-SC3508	ST-WRT15			
	40-200-10-32-4T	●	40	200	55	32	4T	10	ST-SC3508	ST-WRT15			

TURNING

GROOVING

THREADING

MILLING

DRILLING

ENDMILLS

DRILLS

SPARE PARTS

INDEX

carbide

305

TURNING

GROOVING

THREADING

MILLING

DRILLING

ENDMILLS

DRILLS

SPARE PARTS

INDEX

# MSRD

## RD□□

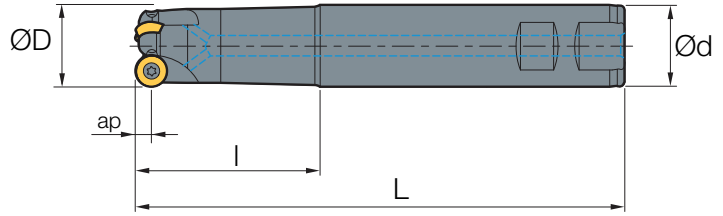



RD□□	DESCRIPTION		STOCK	DIMENSIONS									
				D	L	l	d	Z	ap				
RD□□12	MSRD	25-120-12-25-2T	●	25	120	55	25	2T	08	ST-SC3508	ST-WRT15		
		25-160-12-25-2T	●	25	160	55	25	2T	08	ST-SC3508	ST-WRT15		
		25-200-12-25-2T	●	25	200	55	25	2T	08	ST-SC3508	ST-WRT15		
		32-120-12-32-3T	●	32	120	55	32	3T	10	ST-SC3508	ST-WRT15		
		32-160-12-32-3T	●	32	160	55	32	3T	10	ST-SC3508	ST-WRT15		
		32-200-12-32-3T	●	32	200	55	32	3T	10	ST-SC3508	ST-WRT15		
		40-120-12-32-4T	●	40	120	55	32	4T	10	ST-SC3508	ST-WRT15		
		40-200-12-32-4T	●	40	200	55	32	4T	10	ST-SC3508	ST-WRT15		

carbide  305

# MMRD

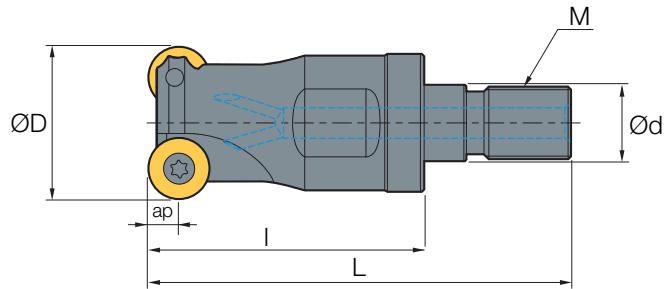
## RD□□



RD□□	DESCRIPTION	STOCK	DIMENSIONS							ap	M				
			D	L	l	d	Z								
RD□□08	MMRD 16-M08-08-2T-C	●	16	52	23	13	2T	4	08	ST-SC0256	ST-WRT08				
	20-M10-08-3T-C	●	20	52	30	18	3T	4	10	ST-SC0256	ST-WRT08				
	25-M12-08-4T-C	●	25	52	35	21	4T	4	12	ST-SC0256	ST-WRT08				
RD□□10	MMRD 20-M10-10-2T-C	●	20	52	30	18	2T	5	10	ST-SC3508	ST-WRT15				
	25-M12-10-3T-C	●	25	52	35	21	3T	5	12	ST-SC3508	ST-WRT15				
	30-M16-10-3T-C	●	30	64	43	29	3T	5	16	ST-SC3508	ST-WRT15				
	32-M16-10-4T-C	●	32	64	43	29	4T	5	16	ST-SC3508	ST-WRT15				
	35-M16-10-4T-C	●	35	64	43	29	4T	5	16	ST-SC3508	ST-WRT15				
	40-M16-10-4T-C	●	40	67	43	29	4T	5	16	ST-SC3508	ST-WRT15				
	42-M16-10-5T-C	●	42	67	43	29	4T	5	16	ST-SC3508	ST-WRT15				
RD□□12	MMRD 24-M12-12-2T-C	●	24	52	35	21	2T	6	12	ST-SC3508	ST-WRT15				
	25-M12-12-2T-C	●	25	52	35	21	2T	6	12	ST-SC3508	ST-WRT15				
	32-M16-12-3T-C	●	32	64	43	29	3T	6	16	ST-SC3508	ST-WRT15				
	35-M16-12-3T-C	●	35	64	43	29	3T	6	16	ST-SC3508	ST-WRT15				
	40-M16-12-4T-C	●	40	67	43	29	4T	6	16	ST-SC3508	ST-WRT15				
	42-M16-12-4T-C	●	42	67	43	29	4T	6	16	ST-SC3508	ST-WRT15				

carbide ▶ 305

- TURNING
- GROOVING
- THREADING
- MILLING
- DRILLING
- ENDMILLS
- DRILLS
- SPARE PARTS
- INDEX

TURNING

GROOVING

THREADING

MILLING

DRILLING

ENDMILLS

DRILLS

SPARE PARTS

INDEX

# MFRD

## RD□□

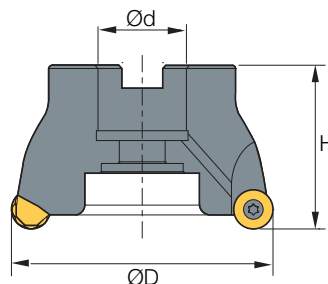

RD□□	DESCRIPTION	STOCK	DIMENSIONS								
			D	H	d	ap	Z				
RD□□10	MFRD 040R-10-4T	●	40	40	16	5	4T	ST-SC3509	ST-WRT15		
	040R-10-4T-C	●	40	40	16	5	4T	ST-SC3509	ST-WRT15		
	050R-10-5T	●	50	50	22	5	5T	ST-SC3509	ST-WRT15		
	050R-10-5T-C	●	50	50	22	5	5T	ST-SC3509	ST-WRT15		
	063R-10-6T	●	63	50	27	5	6T	ST-SC3509	ST-WRT15		
	063R-10-6T-C	●	63	50	27	5	6T	ST-SC3509	ST-WRT15		
	080R-10-7T	●	80	50	27	5	7T	ST-SC3509	ST-WRT15		
	080R-10-7T-C	●	80	50	27	5	7T	ST-SC3509	ST-WRT15		
	100R-10-8T	●	100	50	32	5	8T	ST-SC3509	ST-WRT15		
	100R-10-8T-C	●	100	50	32	5	8T	ST-SC3509	ST-WRT15		
	125R-10-9T	●	125	63	40	5	9T	ST-SC3509	ST-WRT15		
RD□□12	MFRD 040R-12-4T	●	40	40	16	6	4T	ST-SC3509	ST-WRT15		
	040R-12-4T-C	●	40	40	16	6	4T	ST-SC3509	ST-WRT15		
	050R-12-5T	●	50	50	22	6	5T	ST-SC3509	ST-WRT15		
	050R-12-5T-C	●	50	50	22	6	5T	ST-SC3509	ST-WRT15		
	063R-12-6T	●	63	50	27	6	6T	ST-SC3509	ST-WRT15		
	063R-12-6T-C	●	63	50	27	6	6T	ST-SC3509	ST-WRT15		
	080R-12-7T	●	80	50	27	6	7T	ST-SC3509	ST-WRT15		
	080R-12-7T-C	●	80	50	27	6	7T	ST-SC3509	ST-WRT15		
	100R-12-8T	●	100	50	32	6	8T	ST-SC3509	ST-WRT15		
	100R-12-8T-C	●	125	50	32	6	8T	ST-SC3509	ST-WRT15		
	125R-12-9T	●	125	63	40	6	9T	ST-SC3509	ST-WRT15		

carbide

305



# MSRT

## RT□□

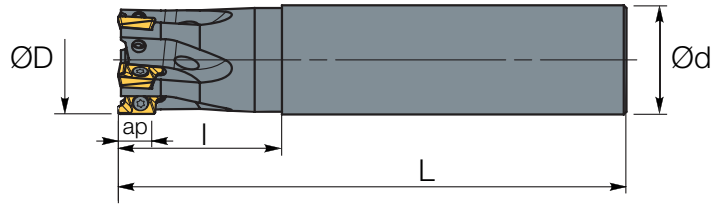

RT□□	DESCRIPTION	STOCK	DIMENSIONS										
			D	L	l	d	Z	ap					
RT□□07	MSRT 10-120-07-10-2T	●	10	120	30	10	2T	07	ST-SC0204	ST-WRT06			
	12-120-07-12-2T	●	12	120	30	12	2T	07	ST-SC0204	ST-WRT06			
	14-120-07-12-2T	●	14	120	30	12	2T	07	ST-SC0204	ST-WRT06			
RT□□10	MSRT 16-120-10-16-2T	●	16	120	30	16	2T	10	ST-SC02507	ST-WRT08			
	16-150-10-16-2T	●	16	150	40	16	2T	10	ST-SC02507	ST-WRT08			
	16-200-10-16-2T	●	16	200	50	16	2T	10	ST-SC02507	ST-WRT08			
	17-150-10-16-2T	●	17	150	40	16	2T	10	ST-SC02507	ST-WRT08			
	18-120-10-16-2T	●	18	120	30	16	2T	10	ST-SC02507	ST-WRT08			
	20-120-10-20-3T	●	20	120	30	20	2T	10	ST-SC02507	ST-WRT08			
	20-150-10-20-3T	●	20	150	40	20	3T	10	ST-SC02507	ST-WRT08			
	20-200-10-20-3T	●	20	200	50	20	3T	10	ST-SC02507	ST-WRT08			
	22-120-10-20-3T	●	22	120	30	20	3T	10	ST-SC02507	ST-WRT08			
	22-150-10-20-3T	●	22	150	40	20	3T	10	ST-SC02507	ST-WRT08			
	22-200-10-20-3T	●	22	200	50	20	3T	10	ST-SC02507	ST-WRT08			
	25-120-10-25-4T	●	25	120	30	25	4T	10	ST-SC02507	ST-WRT08			
	25-150-10-25-4T	●	25	150	40	25	4T	10	ST-SC02507	ST-WRT08			
	25-200-10-25-4T	●	25	200	50	25	4T	10	ST-SC02507	ST-WRT08			
	32-120-10-32-5T	●	32	120	30	32	5T	10	ST-SC02507	ST-WRT08			
32-150-10-32-5T	●	32	150	40	32	5T	10	ST-SC02507	ST-WRT08				
32-200-10-32-5T	●	32	200	50	32	5T	10	ST-SC02507	ST-WRT08				

TURNING

GROOVING

THREADING

MILLING

DRILLING

ENDMILLS

DRILLS

SPARE PARTS

INDEX

carbide

306

TURNING

GROOVING

THREADING

MILLING

DRILLING

ENDMILLS

DRILLS

SPARE PARTS

INDEX

# MMRT

## RT

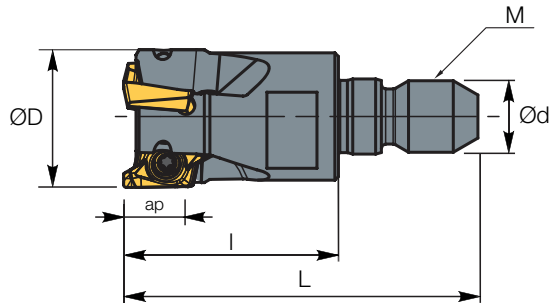

RD□□	DESCRIPTION	STOCK	DIMENSIONS											
			D	L	l	d	Z	ap	M					
RT□□10	MMRT 25-M12-10-4T-C	●	25	52	23	25	4T	10	12	ST-SC0257	ST-WRT08			
	32-M16-10-5T-C	●	32	64	30	32	5T	10	16	ST-SC0257	ST-WRT08			
	42-M16-10-6T-C	●	42	67	35	42	6T	10	16	ST-SC0257	ST-WRT08			

# MFRT

## RT

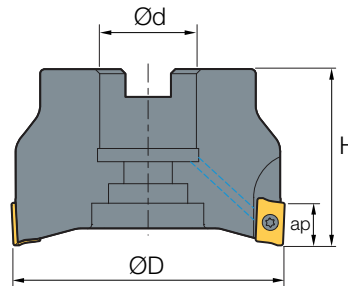

RT□□	DESCRIPTION	STOCK	DIMENSIONS									
			D	H	d	ap	Z					
RT□□10	MFRT 90040R-10-6T	●	40	40	16	10	6T	ST-SC0257	ST-WRT08			
	90040R-10-6T-C	●	40	40	16	10	6T	ST-SC0257	ST-WRT08			
	90050R-10-7T	●	50	40	22	10	7T	ST-SC0257	ST-WRT08			
	90050R-10-7T-C	●	50	40	22	10	7T	ST-SC0257	ST-WRT08			
	90063R-10-9T	●	63	40	27	10	9T	ST-SC0257	ST-WRT08			
	90063R-10-9T-C	●	63	40	27	10	9T	ST-SC0257	ST-WRT08			

carbide

306

# MFSE

## SE□□12

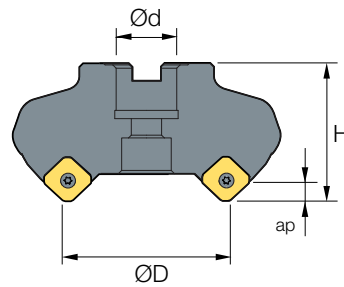



SE□□	DESCRIPTION	STOCK	DIMENSIONS								
			D	H	d	ap	Z				
SE□□12	MFSE 45050R-4T	●	40	40	22	6	4T	ST-SC0359	ST-WRT15		
	45050R-4T-C	●	40	40	22	6	4T	ST-SC0359	ST-WRT15		
	45063R-5T	●	63	40	22	6	5T	ST-SC0359	ST-WRT15		
	45063R-5T-C	●	63	40	22	6	5T	ST-SC0359	ST-WRT15		
	45080R-6T	●	80	50	27	6	6T	ST-SC0359	ST-WRT15		
	45080R-6T-C	●	80	50	27	6	6T	ST-SC0359	ST-WRT15		
	45100R-7T	●	100	50	32	6	7T	ST-SC0359	ST-WRT15		
	45100R-7T-C	●	100	50	32	6	7T	ST-SC0359	ST-WRT15		
	45125R-8T	●	125	63	40	6	8T	ST-SC0359	ST-WRT15		
	45160R-10T	●	160	63	40	6	10T	ST-SC0359	ST-WRT15		

carbide  307

## MFSN

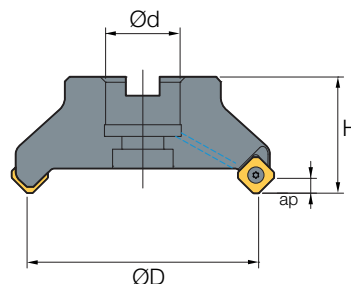
### SN□□ 12



SN□□	DESCRIPTION	STOCK	DIMENSIONS									
			D	H	d	ap	Z					
SN□□12	MFSN 45050R-5T	●	50	40	22	6	5T	ST-SC0411	ST-WRT15			
	45050R-5T-C	●	50	40	22	6	5T	ST-SC0411	ST-WRT15			
	45063R-7T	●	63	40	22	6	7T	ST-SC0411	ST-WRT15			
	45063R-7T-C	●	63	40	22	6	7T	ST-SC0411	ST-WRT15			
	45080R-8T	●	80	50	27	6	8T	ST-SC0411	ST-WRT15			
	45080R-8T-C	●	80	50	27	6	8T	ST-SC0411	ST-WRT15			
	45100R-10T	●	100	50	32	6	10T	ST-SC0411	ST-WRT15			
	45100R-10T-C	●	100	50	32	6	10T	ST-SC0411	ST-WRT15			
	45125R-11T	●	125	63	40	6	11T	ST-SC0411	ST-WRT15			
	45160R-12T	●	160	63	40	6	12T	ST-SC0411	ST-WRT15			
	45200R-14T	●	200	63	60	6	14T	ST-SC0411	ST-WRT15			

carbide ▶ 308

- TURNING
- GROOVING
- THREADING
- MILLING
- DRILLING
- ENDMILLS
- DRILLS
- SPARE PARTS
- INDEX

# MSSO

# SOMW

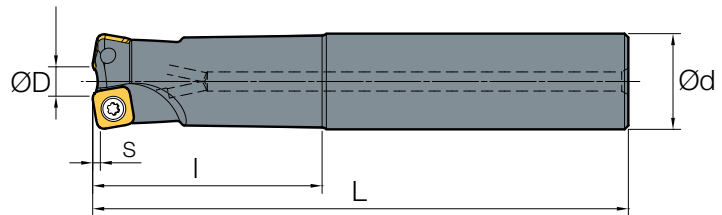

SO□□	DESCRIPTION		STOCK	DIMENSIONS						PROGRAM RADIUS	MAX. ANGLE FOR RAMPING		
				D	L	l	d	Z	S				
SOMW08	MSSO	20-160-08-20-2T	●	20	160	40	20	2T	2	2,5	2°30'	ST-SC0309	ST-WRT15
		20-200-08-20-2T	●	20	200	50	20	2T	2	2,5	2°30'	ST-SC0309	ST-WRT15
		25-160-08-25-3T	●	25	160	40	25	3T	2	2,5	1°30'	ST-SC0309	ST-WRT15
		25-200-08-25-3T	●	25	200	50	25	3T	2	2,5	1°30'	ST-SC0309	ST-WRT15
		32-160-08-32-4T	●	32	160	40	32	4T	2	2,5	1°00'	ST-SC0309	ST-WRT15
		32-200-08-32-4T	●	32	200	50	32	4T	2	2,5	1°00'	ST-SC0309	ST-WRT15

# MMSO

# SOMW

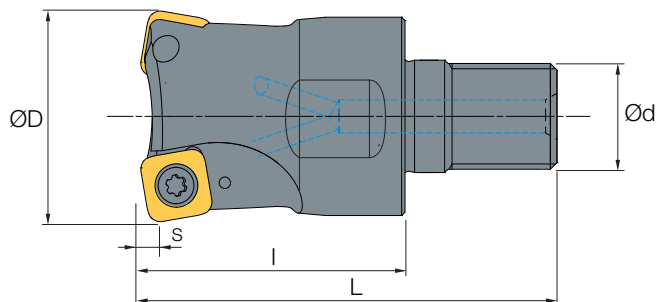

SO□□	DESCRIPTION		STOCK	DIMENSIONS							PROGRAM RADIUS	MAX. ANGLE FOR RAMPING		
				D	L	l	d	Z	S	M				
SOMW08	MMSO	20-M10-08-2T-C	●	20	52	30	12,5	2T	2	10	2,5	2°30'	ST-SC0309	ST-WRT15
		25-M12-08-3T-C	●	25	52	35	12,5	3T	2	12	2,5	1°30'	ST-SC0309	ST-WRT15
		32-M16-08-4T-C	●	32	64	43	17	4T	2	16	2,5	1°00'	ST-SC0309	ST-WRT15
		40-M16-08-5T-C	●	40	67	43	17	5T	2	16	2,5	0°50'	ST-SC0309	ST-WRT15
		42-M16-08-5T-C	●	42	67	43	17	5T	2	16	2,5	0°40'	ST-SC0309	ST-WRT15

carbide

309

TURNING

GROOVING

THREADING

MILLING

DRILLING

ENDMILLS

DRILLS

SPARE PARTS

INDEX

# MFSO

# SOMW

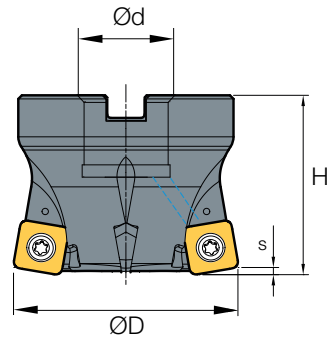

SO□□	DESCRIPTION		STOCK	DIMENSIONS					PROGRAM RADIUS	MAX. ANGLE FOR RAMPING		
				D	H	d	S	Z				
SOMW08	MFSO	040R-08-5T-C	●	40	40	16	2	5T	2,5	0°50'	ST-SC0309	ST-WRT15
		050R-08-6T-C	●	50	40	22	2	6T	3,5	0°40'	ST-SC0309	ST-WRT15
		063R-08-7T-C	●	63	40	22	2	7T	3,5	0°30'	ST-SC0309	ST-WRT15

# MFSP

# SPMW

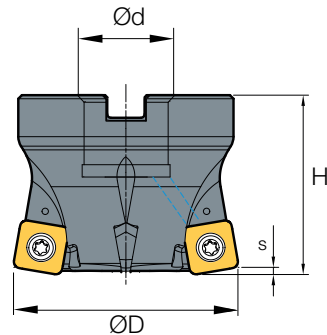

SO□□	DESCRIPTION		STOCK	DIMENSIONS					PROGRAM RADIUS	MAX. ANGLE FOR RAMPING		
				D	H	d	S	Z				
SPMW12	MFSP	050R-12-4T-C	●	50	40	22	3	4T	4,0	1°00'	ST-SC0410	ST-WRT15
		063R-12-6T-C	●	63	40	22	3	6T	4,5	0°40'	ST-SC0410	ST-WRT15

carbide

309

# MFTP

## TP□□

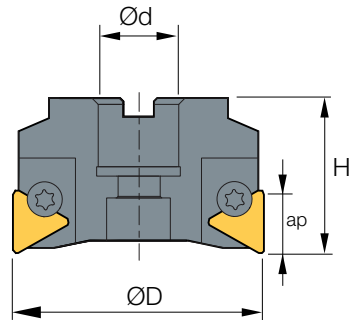

TP□□	DESCRIPTION	STOCK	DIMENSIONS									
			D	H	d	ap	Z					
TP□□16	MFTP 90050R-16-4T	●	50	40	22	12	4T	ST-SC0610	ST-WR0040			
	90063R-16-5T	●	63	45	22	12	5T	ST-SC0610	ST-WR0040			
	90080R-16-6T	●	80	50	27	12	6T	ST-SC0610	ST-WR0040			
	90100R-16-7T	●	100	50	32	12	7T	ST-SC0610	ST-WR0040			
	90125R-16-8T	●	125	63	40	12	8T	ST-SC0610	ST-WR0040			
	90160R-16-9T	●	160	63	40	12	9T	ST-SC0610	ST-WR0040			
TP□□22	MFTP 90063R-22-3T	●	63	45	22	18	3T	ST-SC0810	ST-WR0050			
	90063R-22-4T	●	63	45	22	18	4T	ST-SC0810	ST-WR0050			
	90080R-22-5T	●	80	50	27	18	5T	ST-SC0810	ST-WR0050			
	90100R-22-6T	●	100	50	32	18	6T	ST-SC0810	ST-WR0050			
	90125R-22-7T	●	125	63	40	18	7T	ST-SC0810	ST-WR0050			
	90160R-22-8T	●	160	63	40	18	8T	ST-SC0810	ST-WR0050			
	90200R-22-11T	●	200	63	60	18	11T	ST-SC0810	ST-WR0050			

carbide 311

- TURNING
- GROOVING
- THREADING
- MILLING
- DRILLING
- ENDMILLS
- DRILLS
- SPARE PARTS
- INDEX

TURNING

GROOVING

THREADING

MILLING

DRILLING

ENDMILLS

DRILLS

SPARE PARTS

INDEX

### MSTW

TW □□

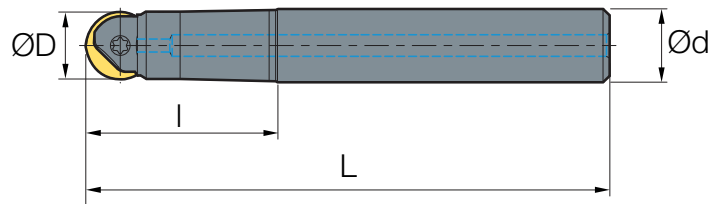

TW□□	DESCRIPTION		STOCK	DIMENSIONS								
				D	L	l	d	Z				
TW08	MSTW	08-110-D10	●	08	110	25	08	1T	ST-TC170	ST-WRT08		
TW10	MSTW	10-130-D12	●	10	130	30	10	1T	ST-TC172	ST-WRT15		
TW12	MSTW	12-130-D12	●	12	130	32	12	1T	ST-TC174	ST-WRT20		
TW16	MSTW	16-175-D16	●	16	175	60	16	1T	ST-TC176	ST-WRT20		
TW20	MSTW	20-200-D20	●	20	200	100	20	1T	ST-TC178	ST-WRT20		
TW25	MSTW	25-200-D25	●	25	200	100	25	1T	ST-TC181	ST-WR0030		

### MMTW

TW □□

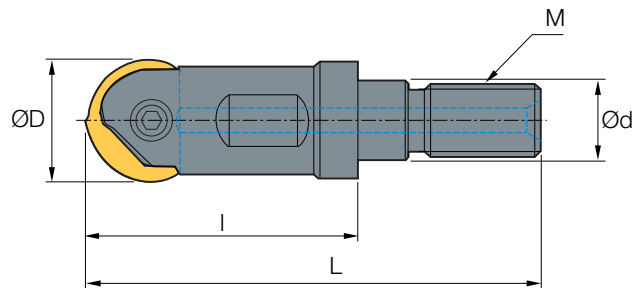

TW□□	DESCRIPTION		STOCK	DIMENSIONS									
				D	L	l	d	Z	M				
TW16	MMTW	16-M08-16	●	16	52	30	10,5	1T	8	ST-TC176	ST-WRT20		
TW20	MMTW	20-M10-20	●	20	52	35	12,5	1T	10	ST-TC178	ST-WRT20		
TW25	MMTW	25-M12-25	●	25	64	43	17	1T	12	ST-TC181	ST-WR0030		

carbide

312





TURNING

GROOVING

THREADING

MILLING

DRILLING

ENDMILLS

DRILLS

SPARE PARTS

INDEX

### MAT

### Steel Shaft



	DESCRIPTION	STOCK	DIMENSIONS								
			D	d	L	l	M				
MAT	M10-120-S18/20	●	18	20	120	60	10				
	M10-170-S18/20	●	18	20	170	90	10				
	M12-160-S24/25	●	24	25	160	80	12				
	M12-200-S24/25	●	24	25	200	100	12				
	M12-250-S24/25	●	24	25	250	150	12				
	M16-160-S31/32	●	31	32	160	80	16				
	M16-200-S31/32	●	31	32	200	100	16				
	M16-250-S31/32	●	31	32	250	150	16				

### MFT

### Carbide Shaft



	DESCRIPTION	STOCK	DIMENSIONS								
			D	d	L	l	M				
MFT	08-08-100-M4	●	8	8	100	-	M4				
	10-10-080-M5	●	10	10	80	-	M5				
	10-10-100-M5	●	10	10	100	-	M5				
	10-10-100-M6	●	10	10	100	-	M6				
	10-10-150-M5	●	10	10	150	-	M5				
	12-12-100-M6	●	12	12	100	-	M6				
	12-12-150-M6	●	12	12	150	-	M6				
	12-12-200-M6	●	12	12	200	-	M6				

# MFT

## Carbide Shaft



	DESCRIPTION	STOCK	DIMENSIONS								
			D	d	L	l	M				
MFT	16-15-100-M8	●	16	15	100	50	M8				
	16-15-150-M8	●	16	15	150	50	M8				
	16-15-200-M8	●	16	15	200	50	M8				
	17-16-100-M8	●	16	16	100	-	M8				
	17-16-150-M8	●	16	16	150	-	M8				
	17-16-200-M8	●	16	16	200	-	M8				
	17-16-250-M8	●	16	16	250	-	M8				
	17-16-300-M8	●	16	16	300	-	M8				
	20-19-150-M10	●	20	19	150	50	M10				
	20-19-250-M10	●	20	19	250	100	M10				
	21-20-100-M10	●	20	20	100	-	M10				
	21-20-150-M10	●	20	20	150	-	M10				
	21-20-200-M10	●	20	20	200	-	M10				
	21-20-250-M10	●	20	20	250	-	M10				
	21-20-300-M10	●	20	20	300	-	M10				
	25-24-150-M12	●	25	24	150	50	M12				
	25-24-200-M12	●	25	24	200	50	M12				
	25-24-250-M12	●	25	24	250	100	M12				
	25-24-300-M12	●	25	24	300	100	M12				
	26-25-150-M12	●	25	25	150	-	M12				
	26-25-200-M12	●	25	25	200	-	M12				
	26-25-250-M12	●	25	25	250	-	M12				
	26-25-300-M12	●	25	25	300	-	M12				
	35-32-150-M16	●	35	32	150	50	M16				
	35-32-200-M16	●	35	32	200	50	M16				
	35-32-250-M16	●	35	32	250	100	M16				
	35-32-300-M16	●	35	32	300	100	M16				
	35-32-350-M16	●	35	32	350	150	M16				
	35-32-400-M16	●	35	32	400	200	M16				

TURNING

GROOVING

THREADING

MILLING

DRILLING

ENDMILLS

DRILLS

SPARE PARTS

INDEX